

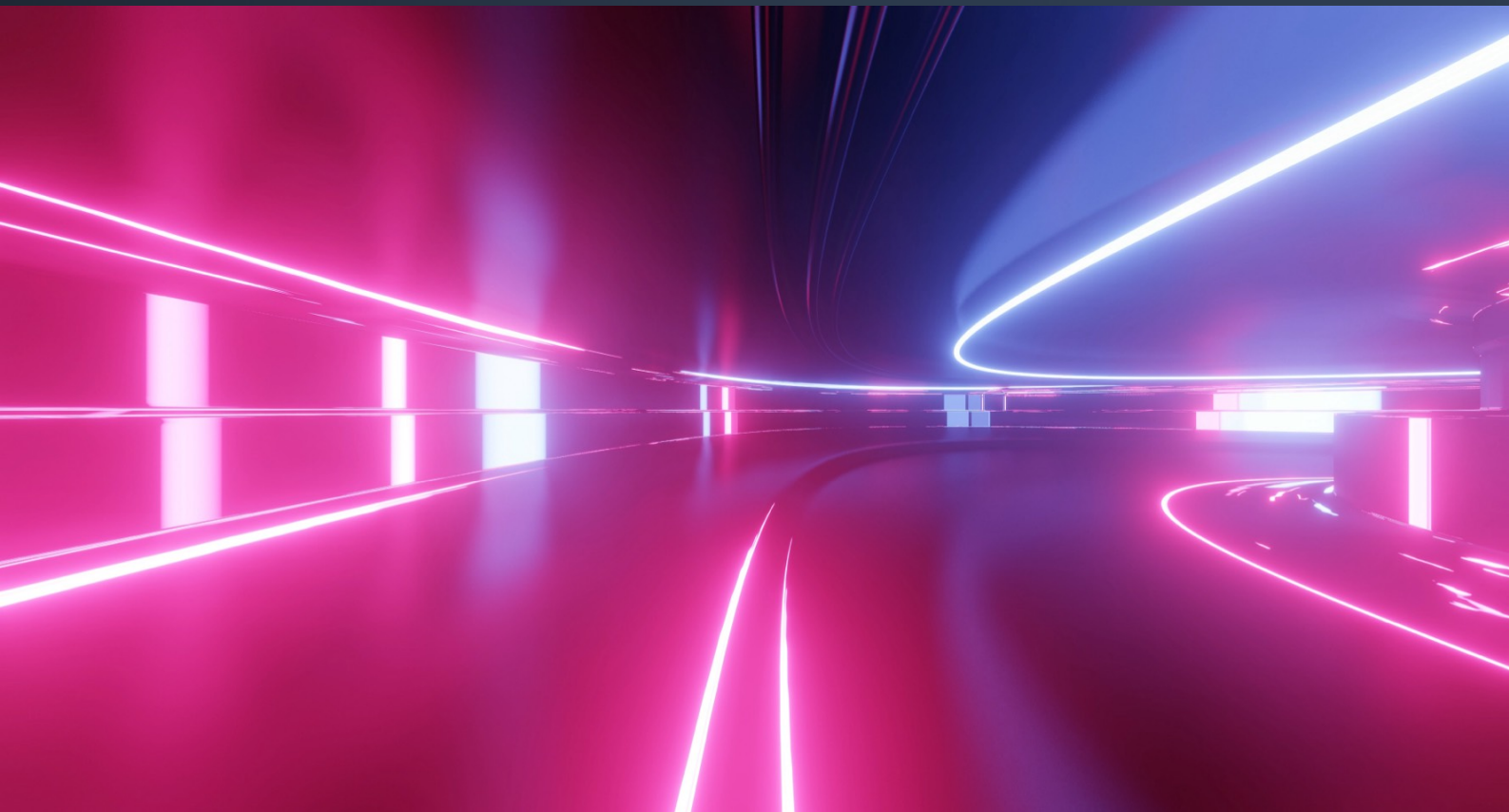

# LIGHTKEY

Professional DMX lighting control.  
Mac style.

User Guide



# Contents

---

<b>Chapter 1 Welcome to the world of Lightkey .....</b>	<b>12</b>
<b>Chapter 2 Intro to DMX .....</b>	<b>14</b>
Connect your fixtures .....	14
DMX interfaces.....	18
Fixture addresses .....	19
<b>Chapter 3 Lightkey licenses.....</b>	<b>21</b>
Buy a license .....	21
Activate your license.....	21
Renew your license.....	22
Move a license between computers .....	23
<b>Chapter 4 Set up your lights .....</b>	<b>25</b>
Step 1: Create a project.....	25
Step 2: Choose an output method .....	26
Step 3: Patch your fixtures .....	27
Find the right fixture profile .....	27
Add your fixtures .....	28
Step 4: Build the Preview .....	30
Locate fixtures .....	31
Size and rotate fixture icons .....	32
Add shapes, images, and text .....	33
Step 5: Group fixtures.....	34
Step 6: Set beam directions.....	35
Step 7: Set beam colors.....	36
You're done .....	36

<b>Chapter 5 Projects .....</b>	<b>38</b>
Create a project .....	39
Open or close a project.....	39
What happens when you close a project .....	40
Rename a project or save a copy.....	40
Manage projects in the Finder.....	41
Search a project.....	41
Undo changes .....	43
<b>Chapter 6 The Lightkey window.....</b>	<b>44</b>
Toolbar .....	45
Customize the Lightkey window.....	46
Full screen view.....	47
Dual windows.....	48
Adaptive background color.....	48
Lock Lightkey.....	49
Keyboard shortcuts and gestures .....	50
<b>Chapter 7 Preview .....</b>	<b>51</b>
Edit the Preview.....	51
Edit objects .....	52
Select objects.....	52
Move objects .....	53
Align objects.....	53
Space objects evenly.....	54
Resize and rotate objects .....	54
Edit fixtures.....	55
Size and rotate fixture icons .....	55
Position fixture names.....	57
Set beam directions .....	58
Set beam colors .....	61
Group fixtures .....	61
Locate fixtures .....	62
Disable fixtures or hide light beams .....	62
Add or remove fixtures .....	63
Edit shapes, images, and text.....	63
Add shapes, images, or text .....	63
Copy and paste shapes, images, and text .....	64

Duplicate shapes, images, and text.....	64
Delete shapes, images, and text.....	65
Flip shapes and images .....	65
Order shapes, images, and text.....	65
Change the style of shapes and images .....	66
Adjust shape features .....	66
Change text formatting .....	67
<b>Chapter 8 Fixture properties .....</b>	<b>69</b>
Select fixtures.....	70
Select all fixtures .....	70
Select fixtures by location.....	70
Select fixtures by type.....	71
Select fixtures by name .....	71
Select fixtures through external control .....	72
Select light beams .....	72
Fixture properties .....	74
Select a fixture property .....	75
Define a fixture property.....	77
Effects .....	78
Dimmer .....	78
Master Dimmer .....	79
Color.....	80
Color Wheel .....	83
Gobo Wheel .....	85
Gobo cycle .....	85
Gobo states .....	86
Shutter/Strobe .....	87
Position .....	89
Movement Speed .....	94
Focus.....	95
Zoom .....	97
Iris .....	98
Prism.....	100
Frost.....	101
Fog .....	102
Custom fixture properties .....	103
Slider .....	104
List of options.....	104



Reorder or hide custom properties .....	105
On/Off .....	106
Lamp .....	106
Command .....	107
Default values .....	107
Copy and paste fixture properties .....	108
View overridden fixture properties .....	109
Clear fixture properties .....	110
Undo changes .....	111
Fanning .....	111
Fan a fixture property .....	112
Edit Fanning .....	116
Delete Fanning .....	116
<b>Chapter 9 Presets and sequences.....</b>	<b>117</b>
Create a preset .....	118
View preset contents .....	119
Activate or deactivate presets .....	120
Edit a preset .....	121
Presets and overridden properties .....	121
Create a preset group.....	123
Create a sequence .....	124
View sequence contents .....	124
Run sequences.....	125
Sequence order.....	125
Reorder sequence steps.....	126
Sequence timing .....	127
Manual timing .....	127
Beat-controlled timing .....	129
Create fixture movements with sequences .....	132
Organize presets and sequences .....	134
Filter items in the Preset Palette .....	136
Export and import items in the Preset Palette .....	136
<b>Chapter 10 Effects .....</b>	<b>138</b>
Pattern effects .....	139
Curve effects .....	139
Movement effects .....	139

Add an effect .....	140
Edit an effect .....	141
Edit effect timing.....	142
Edit the fixture order .....	143
Edit pattern effects .....	144
Chase.....	145
Scanner .....	147
Yo-yo.....	147
Fill.....	148
Rain .....	148
Meteor .....	149
Sparkle .....	150
Fire .....	150
Jellyfish .....	151
Snakes.....	151
Edit curve effects .....	152
Edit movement effects.....	156
Edit paths .....	158
Path types.....	161
Transform paths .....	162
Copy and paste effects.....	163
Delete an effect.....	164
Overlay effects .....	164
Save an effect template .....	165
<b>Chapter 11 Live control.....</b>	<b>167</b>
Live view pages .....	167
Build Live view pages.....	169
Edit a page.....	170
Add cue buttons .....	171
Add text labels.....	172
Select objects .....	172
Move objects.....	173
Attach buttons .....	174
Resize objects .....	174
Duplicate objects.....	175
Copy and paste objects .....	175
Delete objects .....	176

Frames .....	176
Change text formatting .....	178
Set default styles.....	179
Cuelists.....	179
Edit cuelists .....	181
Add cues.....	181
Cue groups .....	182
Cuelist timing .....	183
Select cues for playback.....	185
Organize cues.....	185
Copy and paste cues .....	187
Filter cuelist items .....	187
Edit cue contents and options .....	188
Edit cue contents.....	188
View cue contents .....	190
Edit ad hoc properties.....	191
Edit cue timing options .....	192
Edit button appearance and behavior.....	193
Edit modifiers .....	194
Fade curves .....	198
Live control with cue buttons .....	204
Push buttons .....	204
Faders .....	205
Step through buttons in a frame.....	205
Change modifiers.....	206
Continue effects across cues.....	206
Live control with cuelists.....	207
Control playback .....	207
Manual crossfading.....	208
Activate arbitrary cues.....	208
Change modifiers.....	209
Continue effects across cues.....	210
Blind mode .....	210
Freeze output.....	211
Startup state .....	211
Output order of precedence .....	212
<b>Chapter 12 Beat control.....</b>	<b>214</b>

Beat-controlled sequences .....	215
Beat-controlled effects.....	215
Set the beat grid.....	215
By tapping.....	216
As an exact value .....	216
Through MIDI Beat Clock.....	217
Through Ableton Link .....	218
Examples .....	219
Ableton Live.....	219
Logic Pro .....	220
MultiTracks Playback.....	220
Traktor.....	222
Waveclock .....	223
<b>Chapter 13 Manage DMX fixtures.....</b>	<b>224</b>
Find the right fixture profile .....	226
Filter the fixture library .....	226
Add DMX fixtures .....	227
Edit DMX fixtures .....	228
View and edit DMX fixture information .....	229
Change a fixture's DMX address or universe .....	230
Duplicate fixtures.....	231
Edit a fixture profile .....	232
Reassign fixture profiles.....	232
Disable fixtures .....	233
Delete fixtures.....	233
Export and import fixtures.....	234
Print the patched fixtures.....	237
Work with fixture profiles .....	237
Manage favorite fixture profiles .....	237
Edit a fixture profile .....	237
Import a fixture profile.....	238
Create a fixture profile.....	238
Duplicate a fixture profile .....	239
Delete a fixture profile .....	239
<b>Chapter 14 DMX output and input .....</b>	<b>240</b>
DMX Output settings .....	240
Serial USB Interfaces.....	241

Open DMX Interfaces .....	241
EuroLite USB-DMX512-PRO MK2.....	242
Other USB Interfaces .....	242
Art-Net .....	242
sACN (E1.31).....	246
ESP Net .....	247
Connect to an external OLA server.....	248
Configure universes.....	249
Configure universes on a network node.....	252
If your USB-DMX interface does not appear .....	252
Monitor DMX output.....	253
<b>Chapter 15 Smart lights.....</b>	<b>254</b>
Smart lights vs. DMX .....	255
Manage Hue bridges.....	256
Add a Hue bridge.....	256
Relink Lightkey to a Hue bridge .....	257
Delete a Hue bridge .....	258
Manage smart lights.....	258
View and edit Hue fixture information .....	258
Add a Hue fixture.....	259
Replace a Hue fixture.....	260
Move a fixture between Hue bridges .....	260
Disable a fixture .....	261
Delete a fixture.....	261
<b>Chapter 16 External control .....</b>	<b>263</b>
Quickly assign triggers .....	264
The External Control window .....	266
Configurations.....	267
MIDI inputs .....	268
Bindings .....	269
Triggers .....	272
Actions.....	275
MIDI Shift button .....	279
MIDI notes .....	279
Live Triggers .....	279
Behind the scenes.....	283
Disable Live Triggers .....	284

Troubleshooting .....	284
Trigger actions from ProPresenter .....	285
Send MIDI to other applications .....	287
MIDI routing .....	288
Open Sound Control (OSC).....	289
Connect to Lightkey .....	289
OSC addresses .....	290
Live view .....	291
Preset Palette .....	294
Output control .....	295
Beat control.....	296
Fixture properties .....	296
External Control Log.....	301
macOS shortcuts .....	302
Multi-Touch gestures .....	304
<b>Appendix 1 Shortcuts and gestures .....</b>	<b>306</b>
General.....	306
Application & windows .....	306
Projects .....	307
Editing .....	307
View .....	307
Project setup assistant.....	308
Preview editing .....	308
General.....	308
Selection.....	308
Move .....	309
Fixtures .....	309
Shapes, text & images .....	309
Preview.....	310
Selection.....	310
Fixtures .....	311
Position.....	312
Focus .....	313
Zoom.....	313
Iris .....	314
Design view .....	314
General.....	314

Dimmer .....	314
Color .....	315
Gobo .....	316
Shutter/Strobe .....	316
Prism .....	316
Frost .....	317
Movement Speed.....	317
Fog.....	317
Custom properties .....	318
Preset Palette .....	318
Selection.....	318
Editing .....	318
Live view.....	319
General.....	319
Edit mode .....	320
Cuelists.....	321
Effects .....	322
General.....	322
Curve effects .....	322
Movement paths.....	323
Fixture Manager .....	324
General.....	324
Fixture library .....	324
Channel grid.....	324
Fixture info window.....	325
Fixture editor .....	325
Navigation .....	325
Numeric fields.....	326
Multiple settings .....	326
Custom capabilities.....	326
Beams .....	327
External Control window .....	327
External Control Log window .....	327
User Guide viewer.....	328
<b>Appendix 2 Generic fixture profiles .....</b>	<b>329</b>



# Chapter 1

## Welcome to the world of Lightkey

---

Lightkey is a modern professional lighting controller for live events, nightclubs, churches, and any other kind of venue. Engineered exclusively for Macs, it employs the latest technologies and comes with the familiar look and feel you love.

Thank you for choosing Lightkey! Whether you're a seasoned LJ or a rookie to the world of lighting, Lightkey is a powerful, flexible, and approachable controller for DMX and smart lights, providing all the tools you need to build sophisticated, professional light shows. It was built from the ground up as a native Mac app, leveraging the latest technologies to deliver maximum performance with up to 8192 DMX channels. But beyond that, we hope that Lightkey enhances your creative process and makes it fun to create spectacular light shows.

This User Guide strives to be a comprehensive reference for Lightkey. It covers everything you need to know to use the software, no matter what you want to achieve. If you're a beginner looking to get started, you can also find a series of video tutorials on the [Lightkey website](#).

Lightkey is built on open standards and works with a wide range of USB–DMX interfaces from various manufacturers, in addition to the Art-Net, sACN, or ESP Net network protocols. This is made possible by the Open Lighting Architecture, an open-source framework developed by the Open Lighting Project.

Starting with version 4 smart lights can complement a DMX installation, controlled alongside your DMX lights through the same user interface.

Setting up a lighting installation with Lightkey is quick and easy. It comes with a library of several thousand high-quality fixture profiles, and an interactive assistant guides you through the entire setup process.

When setup is complete, Lightkey makes it easy and fun to build stunning light shows. You can create presets, sequence, and cues, add effects using the powerful effects engine, and synchronize your light show to music.

Lightkey's elegant, Mac-style user interfaces unites all relevant controls in a single, well-arranged window. The white-on-dark controls have been specially designed for low-light environments and provide large clickable areas which work great with touch screens.

Lightkey includes a sophisticated system of keyboard shortcuts and gestures to control virtually every application feature. Once you have mastered these shortcuts, you can work faster than ever before. Beyond that a powerful, fully configurable external control system enables integration with hardware controllers and other software.

But that's not all. We're constantly extending and improving Lightkey—as you can see in the [release notes](#)—and push out updates regularly. If you want to share your ideas or feedback, please [get in touch](#): We love to hear from you.

# Chapter 2

## Intro to DMX

---

DMX512 or simply DMX (Digital Multiplex) is the industry standard for controlling lighting fixtures and other stage equipment. This chapter gives a brief introduction to the DMX technology and how it's used.

Developed in the 1980s, DMX enables a controller—in this case, Lightkey—to send data to various kinds of fixtures. DMX allows for up to 512 control **channels** per data line or universe. Each channel can adopt any value in the range 0 to 255. This was originally designed for dimmers, where zero means 0% brightness and 255 means 100% brightness. While this is still the case with dimmers, DMX channels today control many other aspects of modern fixtures, such as pan, tilt, or color.

### Connect your fixtures

DMX is a unidirectional protocol: The signal travels from the controller to the first fixture and all the way to the last. The fixtures form a “daisy chain” where the “out” port of each fixture is connected to the “in” port of the next fixture with a DMX cable. A **DMX interface** connects the computer to the first fixture. You can connect the fixtures in any order, but try to keep cable lengths to a minimum for optimal data transmission. Because DMX is unidirectional, the software cannot tell which fixtures are connected and whether they actually receive a signal.

A **DMX terminator** is plugged into the “out” port of the last fixture in the chain. It contains a resistor which prevents the signal from “bouncing back” through the signal line. Some modern fixtures are self-terminating and require no terminator if they’re at the end of the DMX chain.

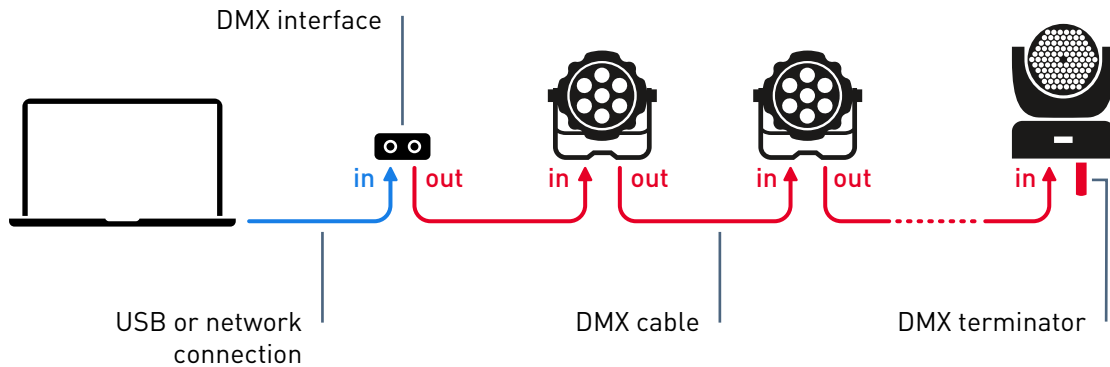

Each daisy chain of fixtures forms a **DMX universe** which operates up to 512 channels. For many installations a single universes is sufficient, but Lightkey can control up to 16 full universes or 8192 channels. Network interfaces with two, four, eight or more outputs let you send DMX to multiple separate DMX chains.

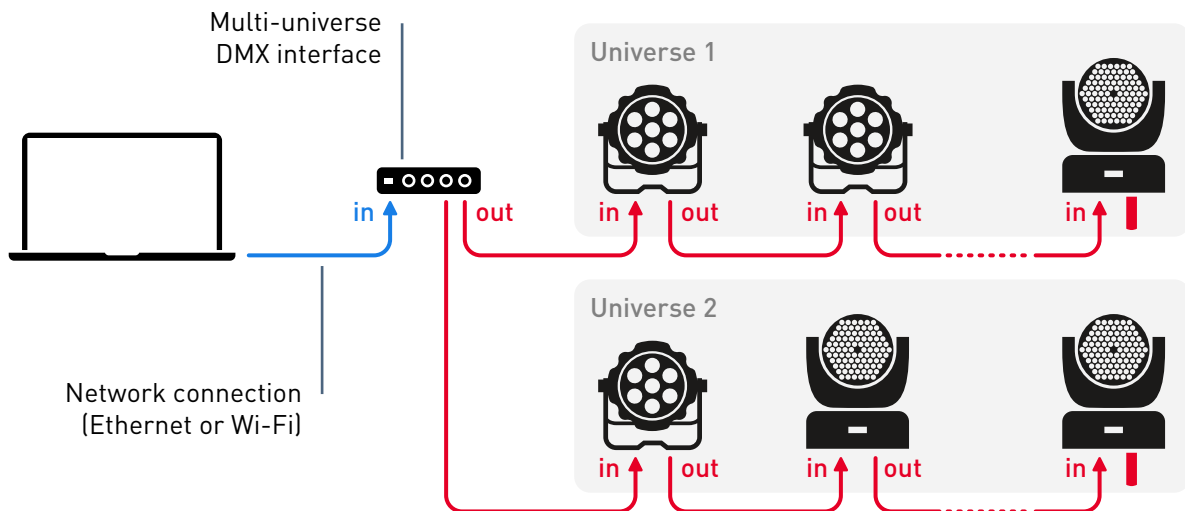

Another way to output multiple universes is to use multiple DMX interfaces. However, there are various limitations which are explained in chapter 14, [DMX output and input](#). For example, Lightkey can only control a single USB interface and a single Art-Net node. Using a single DMX interface is the preferred way to output multiple universes.

The cables which connect the fixtures use XLR connectors with five (XLR-5) or three (XLR-3) pins. Although the original DMX specification stipulated XLR-5 connectors, both types are in common use. From Lightkey’s perspective it doesn’t matter which one you use, and you can mix both types with a suitable adapter. Do not confuse XLR-5 connectors with DIN connectors, often used for MIDI, which look similar but are incompatible to XLR-5.

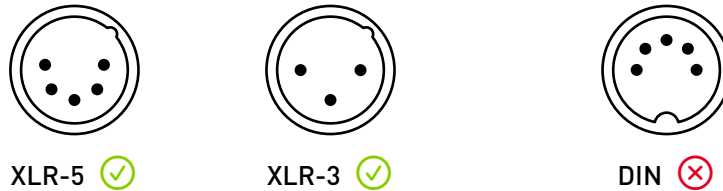

Be sure to use only cables designed for carrying digital signals. Microphone cables, which share the same XLR-3 connectors, are made for analog signals and have a lower impedance. They’re not suitable for DMX and can—even though they may seem to work at first—cause random errors or flicker later on.

If your fixtures fit within a single universe but their layout doesn’t allow for a single run of cables you can use a **DMX splitter** to split the universe into separate DMX chains. A splitter does not change the fixtures’ DMX addresses and the universe is still limited to 512 channels.

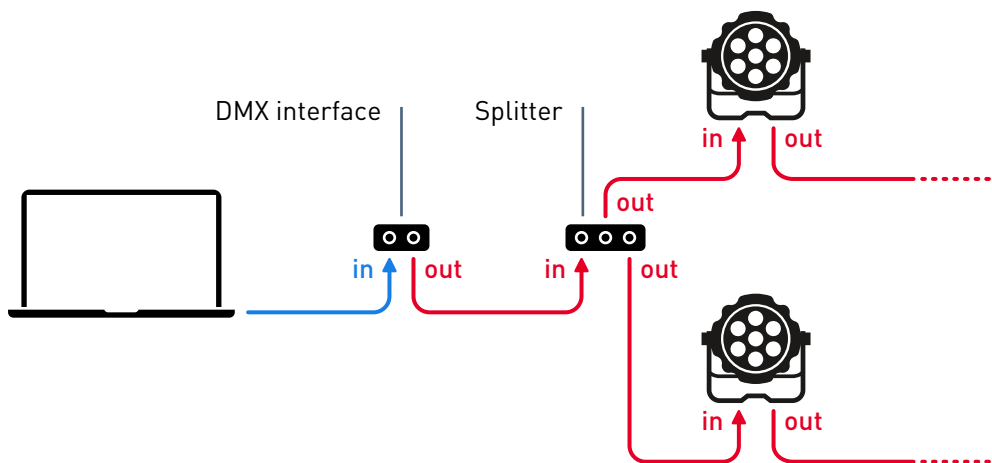

There are splitters with 5- or 3-pin connectors and different numbers of outputs. Most splitters also amplify the signal, which can improve transmission quality over long cable runs.

A **DMX transmitter** lets you send DMX wirelessly (shown below). Other equipment includes **DMX boosters**, which amplify the signal over long cable runs. From Lightkey's perspective it doesn't matter if you employ splitters, transmitters, boosters, or cable adapters along the DMX line. The software does not specifically control those devices and isn't even aware they're there.

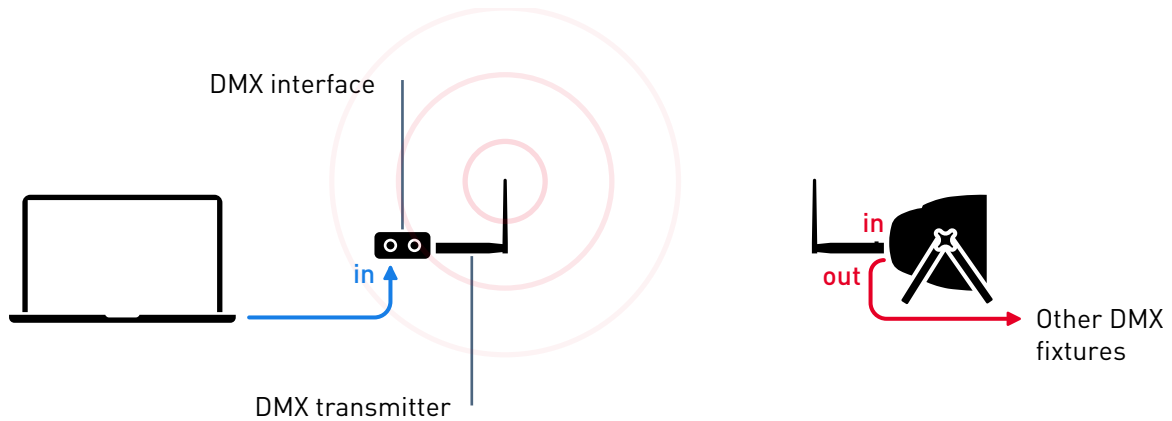

Some fixtures, like traditional PAR cans or house lights, may not have XLR connectors. You can connect their power cables to a **DMX dimmer** or **dimmer pack** which varies its outgoing voltage depending on the DMX input. Use a **switch** or **switch pack** for non-dimmable lights. Never connect a DMX-controlled fixture to a dimmer pack.

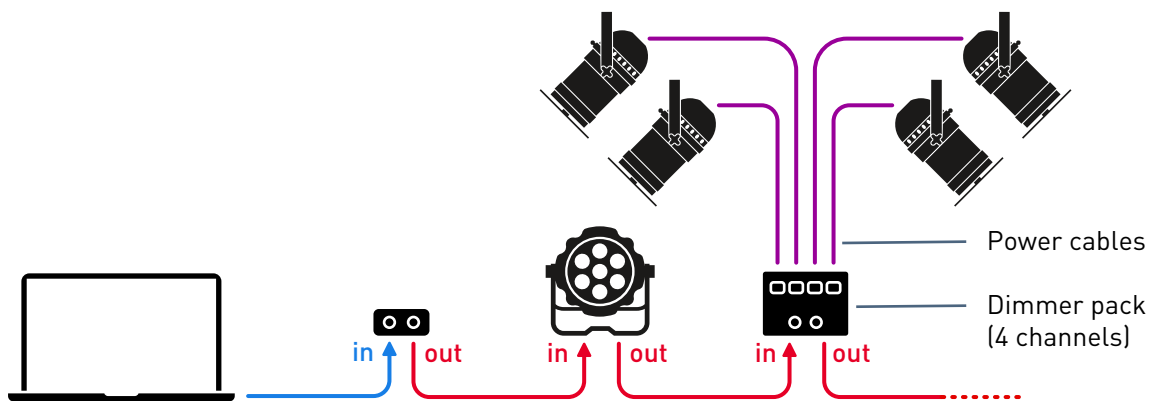

You can connect digital LED strips through a DMX-controlled **decoder** which translates DMX to a PWM (pulse-width modulation) signal for controlling the LED colors. Most decoders control multiple LED strips at once.

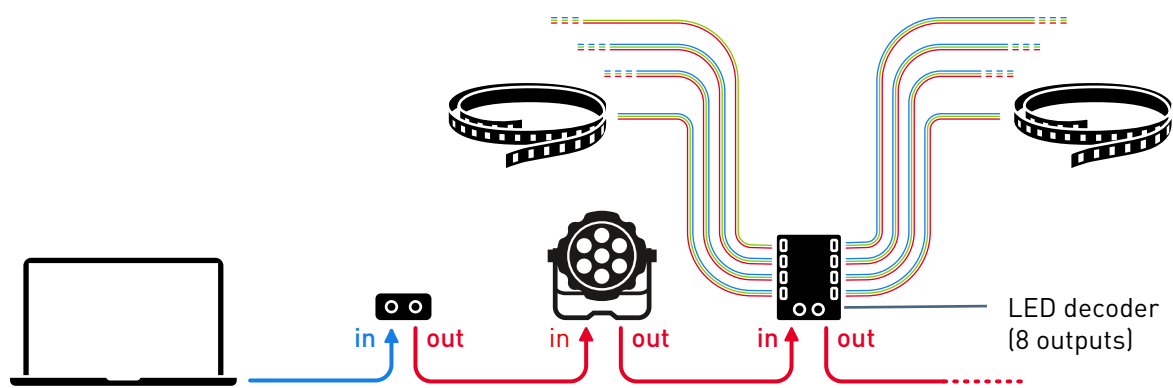

Some more advanced fixtures have RJ45 (Ethernet) ports and can receive data directly from the computer or through an Ethernet router or switch using network protocols like Art-Net or Streaming ACN (sACN or ANSI E1.31). Most of these fixtures also have an RJ45 out port so they can be daisy-chained.

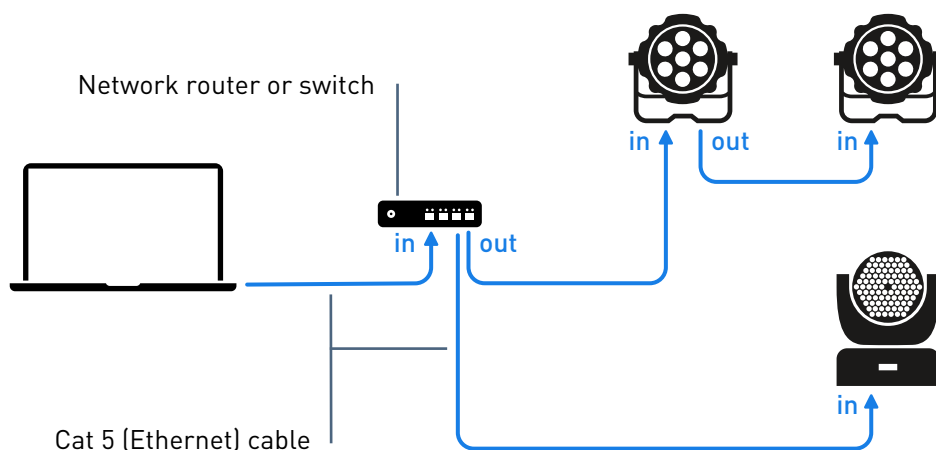

Some network-enabled fixtures can also route the Art-Net or sACN input to their XLR out port, so you can connect more fixtures with DMX cables. The exact capabilities depend on the fixture; please refer to the fixture documentation for details.

## DMX interfaces

The device which connects the DMX network to your computer is called a **DMX interface**. There are two kinds of interfaces:

- **USB-DMX interfaces:** Lightkey works with USB interfaces from various manufacturers. You can find a list [on the Lightkey website](#).



USB interfaces with a built-in microprocessor buffer the DMX data received from the computer. If they don't receive new data they continue to send the last state. Some low-end devices do not have a microprocessor: If the computer is busy and fails to send new data fast enough, the interface sends out zero values, which can cause the lights to flicker.

- **Network interfaces:** Lightkey works with any interface that supports the Art-Net, sACN (ANSI E1.31), or ESP Net protocols. You can use an Ethernet network or Wi-Fi to connect the interface to the computer.

Network protocols can carry a large number of DMX universes, and Ethernet cabling or Wi-Fi are useful for covering long distances. If you want to output more than two universes you need to use a network interface. Lightkey can output up to four universes through Art-Net. Use sACN to output more universes.

## Fixture addresses

Every fixture, dimmer pack, or LED decoder occupies a fixed range of channels within its universe. It's important that these ranges do not overlap. However, it is possible to map multiple identical fixtures to the same range of channels: In this case, they will always behave identically.

The first channel that a fixture occupies is called its **address**. You can choose any address between 1 and 512, as long as the last occupied channel does not exceed 512. For example, if a fixture uses six channels then 507 is the highest possible address (fixture occupies channels 507 through 512). Also, keep in mind that the fixtures' address ranges must not overlap. It's fine if there are unused channels between fixtures.

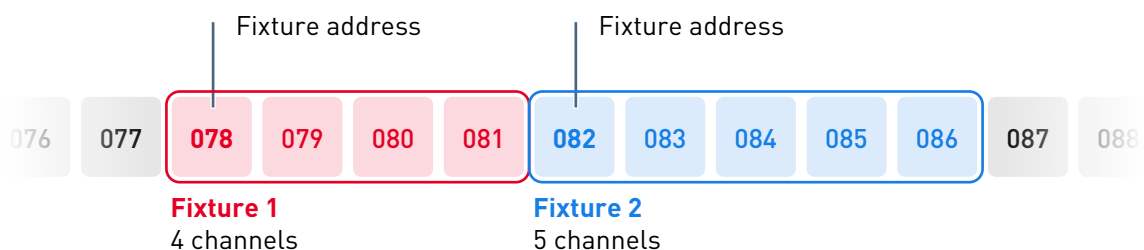

Some fixtures have a DIP switch (Dual In-line Package) for setting the address as a binary number. Other fixtures have an on-device menu. See the documentation that came with your fixture.

How many channels does a fixture occupy? Some fixtures use a fixed number of channels, others have multiple modes (or “personalities”) with different capabilities and a different number of channels. They are described in the fixture’s manual.

Before you begin assigning fixture addresses you should therefore consider which mode suits your needs best, and then determine how many channels each fixture requires. The combined number of channels determines how many universes you need.

# Chapter 3

## Lightkey licenses

---

Without a license output from Lightkey is limited to 24 DMX channels and five Hue lights. A license enables up to 8192 channels and 100 Hue lights.

To use one of the paid Lightkey editions you need to purchase a license and **activate** it on your Mac. Activation binds the license to a particular computer. You can always deactivate the license to move it to a different computer.

### Buy a license

You can buy licenses from the Lightkey Online Store. Licenses are always valid for one year.

#### Go to the Online Store

Do one of the following:

- ▶ Open Lightkey and choose Lightkey → Buy License.
- ▶ Go to [lightkeyapp.com/en/buy](https://lightkeyapp.com/en/buy).

### Activate your license

When the purchase has been completed you receive an email with your license key. You use this key to activate the license on your computer.

For the standard activation process, the computer on which you want to activate a license must be connected to the Internet. There is an alternative way you can use if the computer has no Internet connection.

### Activate your license

- 1 Copy the license key to the Clipboard.
- 2 Open Lightkey and choose Lightkey → Manage License...
- 3 Click Activate License...
- 4 Paste the license key into the text field and then click Activate.

### Activate your license on a computer with no Internet connection

- 1 Copy the license key to the Clipboard.
- 2 Open Lightkey and choose Lightkey → Manage License...
- 3 Click “No Internet connection?”.
- 4 Paste the license key into the text field and then click Save File...
- 5 Choose a destination—for example, the Desktop—and then click Save.  
Lightkey creates an Activation Request file in the selected location.
- 6 Click Done.
- 7 Email the Activation Request file to [activate@lightkeyapp.com](mailto:activate@lightkeyapp.com).

You will shortly receive a reply email with an Activation Response file. We try to process activation requests as soon as possible, but can do so only within our business hours.

- 8 Double-click the Activation Response file.

Lightkey will show a dialog which tells you that it has been successfully activated.

- 9 Click Done.

### Renew your license

A few days before your license expires, Lightkey will show a reminder dialog each time you start the application. In the dialog, you can click Buy License... to go directly to the Lightkey Online Store.

## Renew your license

- 1 Go to the [Lightkey Online Store](#) and select an edition.
- 2 During the purchase process you are asked for the starting date of your license. Enter the date when your old license expires. (To find the expiration date, open Lightkey and choose Lightkey → Manage License...)
- 3 Complete the purchase process. At the end you will receive an email with a new license key.
- 4 On the day when your old license expires, choose Lightkey → Manage License... and then activate the new license:
  - ▶ Click Deactivate License to deactivate the old license.
  - ▶ Click Activate License... and paste the new license key.

Deactivating the license does not affect your data or settings.

## Move a license between computers

A license can only be active on one computer at a time, but you can move it between computers as often as you like. This requires that you deactivate the license on the computer where it's currently activated.

For the standard deactivation process, the computer must be connected to the Internet. There is an alternative way which works similar to the activation process with no Internet connection (see [Activate your license](#) above).

### Move a license to another computer

- 1 Open Lightkey on the computer where your license is currently activated and choose Lightkey → Manage License...
- 2 Click Deactivate License, then click Done. This does not affect your data or settings.
- 3 Activate the license on the new computer, as described in [Activate your license](#).

❖ **Note:** After deactivation, the first computer still “remembers” the license key and suggests it again when you activate a license. This makes it easy to repeatedly move a license between computers.

If you no longer have access to the computer with the active license, please contact our support team.

Moving the license does not move your projects, which are stored locally on the computer. To move a project, use the Finder to copy the project file to the other computer.

# Chapter 4

## Set up your lights

---

Before you can create light shows, you need to tell Lightkey about your lighting installation. An interactive assistant guides you through configuring DMX output, patching your fixtures, and building the virtual Preview.

This chapter is about setting up DMX fixtures. Philips Hue smart lights are discussed in chapter 15, [Smart lights](#).

### Step 1: Create a project

When you first start Lightkey, the Project Browser appears. It shows a preview of the recently used projects (probably none if you're just getting started) and the built-in demo projects.

#### Create a new project

- 1 In the Project Browser, click New Project.
- 2 Enter a name and choose a location for the project file, then click Save.

For more information about projects, see chapter 5, [Projects](#).



## Step 2: Choose an output method

Next, you need to tell Lightkey how you will output DMX. The following options are available:

- **No DMX Output:** Disables DMX output. Use this if you want to test Lightkey with no fixtures connected. You can always add an output method later.
- **USB:** This option shows a list of all connected USB–DMX interfaces that are compatible with Lightkey. If your interface is missing, click Find Devices. If this doesn't help, refer to [If your USB–DMX interface does not appear](#) in chapter 14, [DMX output and input](#).
- **Art-Net:** Art-Net is a communication protocol for distributing DMX data over a local network. Select the network interface which your Art-Net interface is connected to (for example, your computer's Ethernet port) and then select your Art-Net interface from the list. If your interface is missing, click Find Devices. See [DMX Output settings](#) in chapter 14, [DMX output and input](#), for more information.
- **sACN:** Streaming ACN (sACN or ANSI E1.31) is a communication protocol for distributing DMX data over a local network. Select the network interface which your sACN interface is connected to (for example, your computer's Ethernet port). Lightkey sends its output to all sACN nodes on this network, so you don't need to select your sACN interface. See [DMX Output settings](#) in chapter 14, [DMX output and input](#), for more information.
- **ESP Net:** ESP (Enttec Show Protocol) is a DMX-over-Ethernet communication protocol developed by Enttec. Select the network interface which your ESP Net interface is connected to (for example, your computer's Ethernet port). See [DMX Output settings](#) in chapter 14, [DMX output and input](#), for more information.

### Choose an output method

- ▶ Select one of the output methods as described above, then click Next.

Lightkey creates a single DMX universe with the selected output method. If you wish to use multiple universes you can add them later, as described in [Configure universes](#) in chapter 14, [DMX output and input](#). If you wish to add smart lights see chapter 15, [Smart lights](#).

## Step 3: Patch your fixtures

In the next step you will tell Lightkey about your fixtures. For each type of fixture you need a **fixture profile**, a file which contains a description of the fixture's capabilities and the way they are controlled. For each of your fixtures you need to tell Lightkey which **DMX universe** it's connected to and which **DMX address** it responds to.

On the left of the window is the **fixture library** which contains all built-in, imported, and user-created fixture profiles. Lightkey comes with thousands of fixture profiles from many different manufacturers, and it can import many freely available profiles in the formats SSL2, FXT, and PFF. The first column lists the manufacturers, the second column shows the profiles for the selected manufacturer. The library also contains a number of generic profiles which don't relate to a specific fixture model.

On the right is a grid representing the 512 DMX channels in a universe. Your license determines how many channels are available for output. New projects contain a single universe, but you can add more universes later.

### Find the right fixture profile

For simple fixtures you can often use one of the profiles in the Generic category of the built-in library. You can find an [overview of the generic profiles](#) at the end of this User Guide.

The Generic category also includes a selection of flexible fixture profiles ("FLEX"). Flexible fixture profiles are for LED strips and matrixes and let you choose the desired number of LEDs when you patch the fixture.

If your lights are connected through a dimmer pack, patch the generic profiles PAR Wash, PAR Spot, or PAR Beam (depending on the type of light) several times to consecutive channels—once for each light. (For a switch pack, use the generic Switch profile.) The address of the first fixture must match the address of your dimmer/switch pack. This way each light appears as a separate fixture in the Preview and you don't need a fixture profile for the dimmer or switch pack.

For more complex lights, you need a profile specific to the fixture. It's important to use a fixture profile which exactly matches your fixture model, or the fixture will not work correctly. Profiles for other—even similar—lights will often not work.

## Find a profile for a specific fixture

- 1 Browse the built-in fixture library for a matching profile. Use the search field at the top to search by manufacturer or model name. Profile names generally match the name on the cover page of the fixture manual. Double-click a profile to see more information.
  - 2 Check Lightkey's [online fixture library](#). It's frequently updated and contains a large number of high-quality profiles in Lightkey's native format.
  - 3 We can create a profile for you if you send us the fixture's DMX chart (usually part of the manual and/or available as a PDF on the manufacturer's website). [Please use this online form to request a profile](#).
  - 4 Create a profile using Lightkey's built-in fixture editor or import a profile in the formats SSL2 (Sunlite) or PFF/FXT (DMX FreeStyler). There are thousands of free profiles available on the Internet. Note that imported profiles may need a bit of editing in the fixture editor before they work correctly with Lightkey.
- Click ⋮ at the top of the fixture library and then choose New Profile... to create a new profile, or Import Profiles... to import a profile.

## Add your fixtures

Once you have profiles for your fixtures, you can add them to the channel grid. The process of filling the grid with fixtures is called **patching**.

### Add your fixtures

- 1 Drag a fixture profile from the library to the channel grid. The first occupied channel should match the fixture's DMX address. Fixtures must not overlap. The fixture will appear in the channel grid with a dashed outline. Below it you see a window with additional options.



- 2 If the fixture has different operation modes (or “personalities”), select a mode from the pop-up menu below the fixture name. Be sure to select the same mode as on the fixture, or Lightkey will not be able to control the fixture. The mode determines how many channels the fixture occupies.

When patching a flexible LED strip or matrix, you can enter the desired number of LEDs here. The fixture will grow or shrink in the channel grid depending on the number of LEDs.

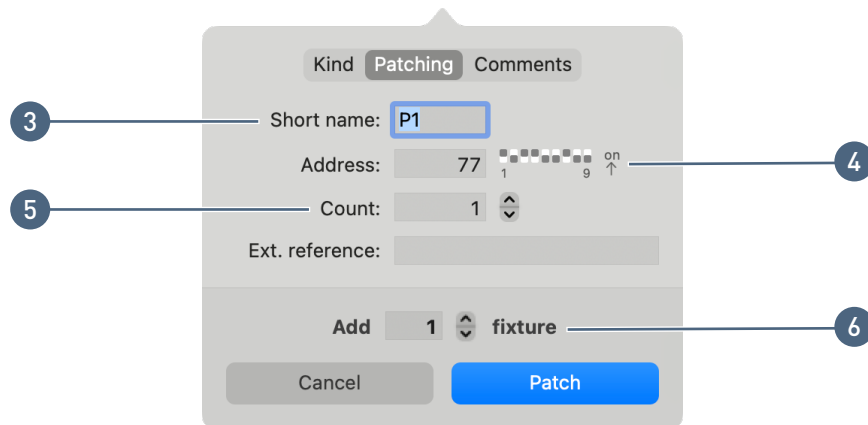

- 3 Assign a short name to the fixture. Short names appear in Lightkey’s Preview; they can be up to four characters long and typically include one or two letters and a number. If the short name ends with a number, you can increase/decrease it by pressing the Up/Down Arrow keys while the insertion point is in the field.

Lightkey proposes a short name based on the fixture type, but you should choose a naming scheme that’s suitable for your lighting installation. For example, if you have a row of PAR cans on the floor and one at the ceiling, you can name them F1, F2, F3, ... and C1, C2, C3, ...

- 4 If necessary, you can correct the fixture’s DMX address in the Address field. (You can increase/decrease the address by pressing the Up/Down Arrow keys while the insertion point is in the field.)
- 5 If the Count value is greater than one, Lightkey displays multiple instances of the fixture in the Preview which always share the same fixture properties. This is useful when you patch several identical fixtures to the same DMX address.
- 6 To patch multiple fixtures of the same type to consecutive DMX addresses, enter their number here. (You can increase/decrease the number by pressing the Up/Down Arrow keys while the insertion point is in the field.)

If the short name ends with a number, Lightkey automatically increments the number for each fixture. For example, if you add four moving heads and enter “MH6”, their names will be MH6 through MH9.

- 7 Click Patch (or press Return).
- 8 Repeat the steps until all fixtures have been added. If you don't have profiles for some fixtures, you can come back and add them later.
- 9 Click Next.

You can change the fixture patching information later. See chapter 13, [Manage DMX fixtures](#), for more information.

## **Step 4: Build the Preview**

Now you begin to build the Preview, a 2D representation of your lighting installation. The next screen shows a number of icons representing fixtures. Drag the icons around so they approximately match the physical locations of your fixtures. You can also add shapes and images.

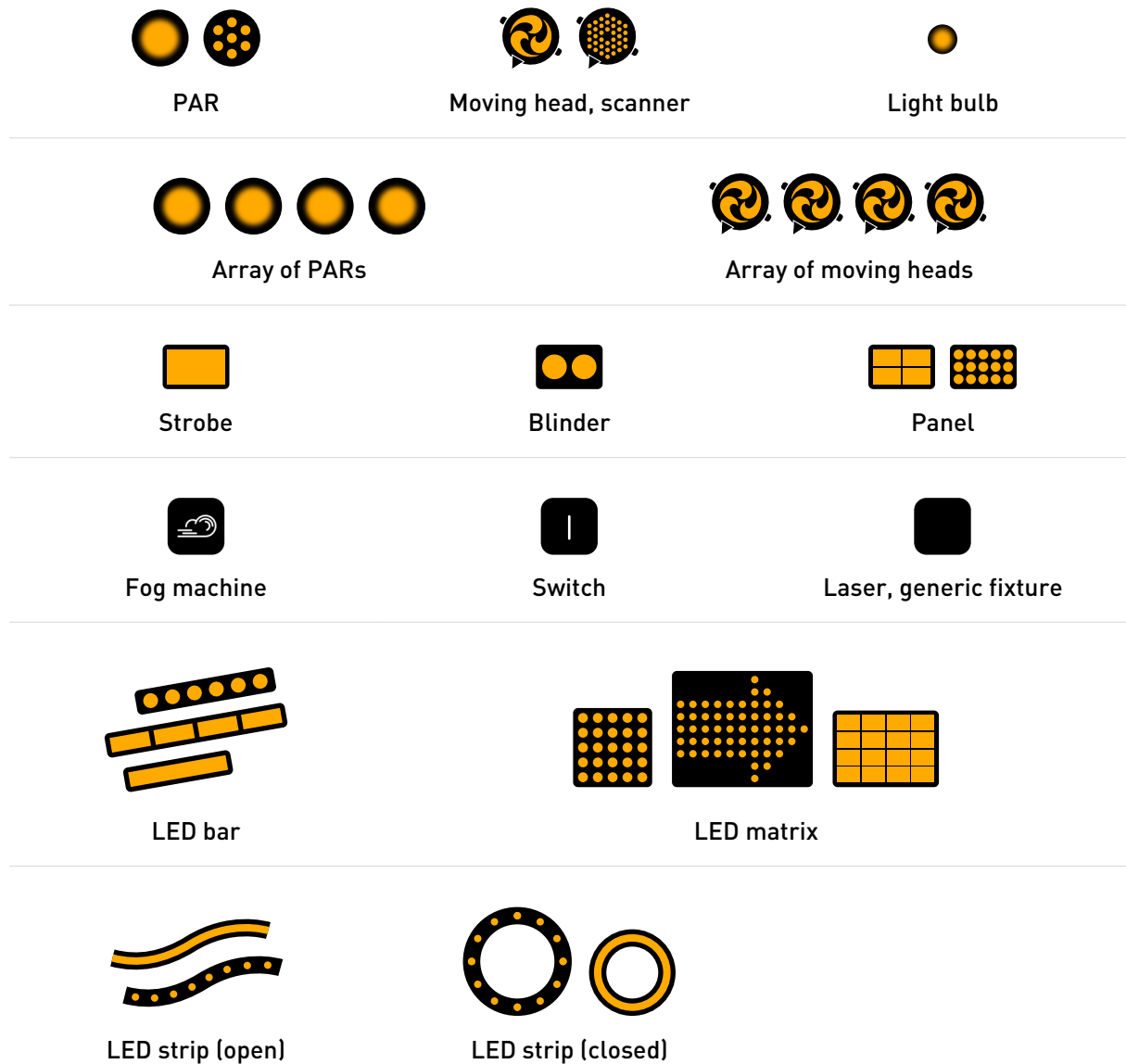

Depending on the venue and the location of the lighting computer you can use a top view (e.g. a floor plan) or a front view (e.g. of your stage).

## Locate fixtures

If you're not sure which fixture a particular icon belongs to, you can use Highlight Mode. When Highlight Mode is enabled, the selected fixture(s) will light up. This works for both DMX fixtures and smart lights.

### Enable Highlight Mode

- ▶ Click  in the toolbar or choose Layout → Highlight Mode (or press Command-Shift-H).

## Size and rotate fixture icons

Change the length and rotation of the icons to reflect the size and placement of the actual fixture. This works for LED fixtures as well as PAR and moving head arrays. You can “bend” LED strips to any shape and choose between two icon sizes for LED fixtures.

Select multiple fixtures to resize or rotate them at once, provided they are of the same type.

### Resize or rotate a fixture icon

- ▶ Click the fixture icon to select it, then drag one of the blue selection handles around it.

### Rotate an LED matrix

- 1 Click the fixture icon to select it.
- 2 Hold down the Command key and drag one of the blue selection handles around it.

### Edit the shape of an LED strip

- 1 Select one or more LED strips.
- 2 Click Edit Shape in the Inspector or press Return.
- 3 Use the yellow handles to change the shape:
  - ▶ To select a single handle, click the handle.
  - ▶ To select multiple handles, press the mouse button over a blank part of the Preview and drag across the handles.
  - ▶ To toggle a handle’s selection state, hold down the Command key and click the handle.
  - ▶ To select a range of handles, click the first handle, then hold down the Shift key and click the last handle in the range.
  - ▶ To select the handles one by one, press Control-Tab. Press Control-Shift-Tab to reverse the order.
  - ▶ To move the selected handles, drag them. You can also press the Arrow keys.



- ▶ To add a handle, place the pointer in between two yellow handles, then click the white handle that appears in between them.
  - ▶ To remove the selected handles, choose Edit → Delete or press the Delete key.
- 4 To end editing the shape, press Return or click in the empty area outside the LED strip.

### Change the icon size of LED strips and matrixes

- 1 Select one or more LED fixtures.
- 2 Click one of the size options on the right.

### Add shapes, images, and text

You can add shapes (such as rectangles, ovals, lines, and trusses) as well as built-in or custom images to create a visual representation of your venue. You can also add text labels.

#### Add an object

Do one of the following:

- ▶ Click either Shapes or Images in the right sidebar, then drag an object to the desired position in the Preview.
- ▶ Choose Layout → Insert and then choose one of the options in the submenu.

#### Add a custom image

Do one of the following:

- ▶ Choose Layout → Insert → Image File..., then select an image file and click Insert. Lightkey can handle all common image formats.
- ▶ To add an image from another application, copy the image to the Clipboard, go to Lightkey, and choose Edit → Paste.
- ▶ Drag an image file from the Finder to the Preview area and position it where you want it.

After adding an image, drag it to the desired location and adjust its size by dragging one of the blue selection handles around it. Hold down the Command key as you resize an image to distort its aspect ratio.

## Add text

- 1 Click Shapes, then place the pointer over the T icon and drag it to the desired location in the Preview.
- 2 Double-click the text to select it, then type.
- 3 To change the text formatting, choose Edit → Font → Show Fonts or click A in the toolbar, then use the Font window to change the font, font size, and other options.
- 4 Click outside the text or press Return to finish editing.

There are many more things you can do when you design your preview. See chapter 7, [Preview](#), for details.

When you are done creating your preview, click Next.

## Step 5: Group fixtures

In the next step you can create groups of similar fixtures. Grouped fixtures can be quickly selected at once, although it is still possible to select them individually. You should group fixtures with the same type and in the same location—for example, a row of blinders above the stage.

### Create a fixture group

- 1 Select the fixtures to be grouped. You can press the mouse button over a blank part of the Preview and drag it over the fixtures. Alternatively, hold down the Shift key and click the fixtures one by one.
- 2 Do one of the following:
  - ▶ Click  in the toolbar.
  - ▶ Control-click one of the fixtures and choose Group from the shortcut menu.
  - ▶ Choose Layout → Group (or press Command-Option-G).

When you're done creating fixture groups, click Next.

## Step 6: Set beam directions

- ❖ **Note:** This step only applies if you have fixtures with virtual light beams (PARs, moving heads, scanners, blinders, strobes, panels, or LED bars).

In this step you tell Lightkey about the positions of your moving and static lights so it can match what you see on the screen with the actual fixture. This is called **calibration**.

### Calibrate the position of a moving light

- 1 Click Set... below the fixture icon.
- 2 Follow the instructions and click Next after each step, or Done after the last step.

- ▶ **Home:** This step tells Lightkey in which direction the fixture is pointing. The fixture moves to the center of its pan range and tilts by 90°.

Imagine you're looking through the base of the moving light in the direction of the pan axis. Drag the arrow until it points in the direction of the light beam.

- ▶ **Rotation:** This step tells Lightkey in which direction the light turns. The light performs a slow pan movement, then turns back in blackout and repeats the movement.

The rotating arrow should follow the direction of the light beam. If necessary, click the arrow to reverse its direction.

- ▶ **Limits:** This step is optional. It allows you to limit the allowed ranges for pan and tilt. This can be useful, for example, to prevent a light from pointing directly at a wall behind it or into the DJ booth.

Drag the handles to limit the allowed ranges for pan and tilt.

- ▶ **Perspective:** This step is important to make the virtual light beams match the fixture. The light moves to the center of its pan and tilt ranges.

Consider the Preview on the screen. Select the direction in which the light beam is currently pointing—to the left or right, up or down, or parallel to the viewing direction.

When calibration is complete, a checkmark appears below the fixture icon.

## Calibrate the position of a static light

- 1 Click Set... below the fixture icon.
- 2 Follow the instructions, then click Done.

When you're done, a checkmark appears below the fixture icon.

★ **Tip:** Select multiple fixtures of the same type to set their beam directions at once (assuming they point in the same direction).

Once you have set the beam positions for all fixtures, click Next.

## Step 7: Set beam colors

❖ **Note:** This step only applies if you have any monochrome fixtures whose color can't be controlled through DMX.

For fixtures with a static color, you need to tell Lightkey the color for the virtual light beam.

### Set a fixture's beam color

- 1 Click Set... below the fixture icon.
- 2 Choose a color.

When you're done, a checkmark appears below the fixture icon.

★ **Tip:** Select multiple fixtures to set their beam colors at once.

Once you have set the beam colors for all fixtures, click Next.

## You're done

After completing these steps, Lightkey is ready to control your lights. Click Get Started, and you will see the normal Lightkey window. For more information about the parts of the window, refer to chapter 6, [The Lightkey window](#).

If you did not complete all steps during the setup, you can come back and change the settings at any time:

- ▶ Click Edit in the toolbar or choose View → Edit Preview to edit the Preview.
- ▶ Click  in the toolbar or choose Lightkey → Manage Fixtures... to add, remove, or change fixtures and manage DMX output settings.

# Chapter 5

## Projects

---

The first thing you see when you open Lightkey is the Project Browser. It shows the most recently used projects (if any) and two demo projects.

A Lightkey **project** is a file which contains all the information about your fixtures and light shows for a given lighting installation. A project contains:

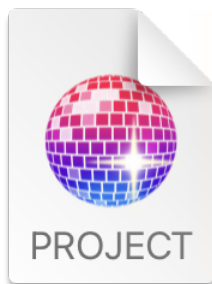

- Your fixtures' patching information
- Configuration information for your universes
- The virtual Preview
- Presets, sequences, and cues
- Effect templates and movement paths
- Live view pages
- Your external control configurations

You can create as many projects as you like, but only one can be open at a time. Having multiple projects can be useful if you use Lightkey in different environments, but in most cases a single project is all you need.

Because Lightkey uses the macOS Auto Save technology, projects are saved automatically in the background.

## Create a project

- 1 If a project is open, choose File → Close Project. The Project Browser appears.
- 2 Click New Project or choose File → New Project.
- 3 Enter a name and choose a location for the project file, then click Save.
- 4 Follow the instructions of the interactive assistant to set up your project. The setup process is explained in chapter 4, [Set up your lights](#).

## Open or close a project

When you start Lightkey, it automatically opens the recently used project. Therefore, as long as you only have a single project, you rarely need to manually open or close projects. When you close a project, all of your changes are saved.

★ **Tip:** To have Lightkey reopen the last project when you start the application, make sure that “Close windows when quitting an application” is turned off in the Desktop & Dock pane of System Settings.

### Open a project

- 1 If another project is currently open, choose File → Close Project. The Project Browser appears.
- 2 Do one of the following:
  - ▶ If the desired project appears in the Project Browser, double-click it.
  - ▶ Choose File → Open..., select a project file, and click Open.
  - ▶ Double-click a project file in the Finder.

### Close the current project

- 1 Do one of the following:
  - ▶ Choose File → Close Project (or press Command-W).
  - ▶ Click the red close button in the upper-left corner of the Lightkey window.
- 2 If Lightkey asks you if you are sure, click Close. This is a precaution to prevent you from accidentally closing the project and turning off all lights.

After closing the project, Lightkey returns to the Project Browser.

## What happens when you close a project

When you close a project or quit the application, Lightkey performs the following steps, in this order, depending on your settings:

- 1 It sets your lights' Dimmer properties to zero. This affects all DMX fixtures which have a Dimmer property and all Hue fixtures.
- 2 It applies any cues with the "Activate before quitting" option for approximately 0.5 seconds. This can be useful to reset moving heads to their home position or turn off fixtures with no Dimmer property. See [Edit button appearance and behavior](#) in chapter 11, [Live control](#).
- 3 If enabled, it sends a "Lamp Off" command to fixtures for a preset duration which turns off their illuminant. This applies to all DMX fixtures which support Lamp On/Off commands.
- 4 If enabled, it sets the channels in all output universes to zero. This can be useful when using other controllers such as DMX wall panels which only take control when all DMX channels are zero.

You can choose which of these steps should be performed in the Settings window.

### Choose what happens when you close a project

- 1 Choose Lightkey → Settings... (or press Command-Comma) and then click General.
- 2 Change the settings in the section labelled "Before quitting".

## Rename a project or save a copy

You can rename the currently open project or save a copy with a new name.

### Rename the current project

- ▶ Click the project name at the top of the window, then type a new name.

### Save a copy of the current project

- 1 Choose File → Save As... (or press Command-Option-Shift-S).
- 2 Enter a name and choose a location for the project file, then click Save.

You can then continue with the copied project.



## Manage projects in the Finder

Use the Finder for other tasks such as duplicating or deleting projects. If you want to move a project to another computer, all you need to do is copy the project file.

### Locate a project in the Finder

- ▶ If the project is currently open, hold down the Command key and click the project's name at the top of the window. A menu appears showing the hierarchy of folders and volumes which contain the project. Select the topmost folder to show the project file in the Finder.
- ▶ If the project is not currently open, Control-click it the Project Browser, then choose Show in Finder from the shortcut menu.

### Move a project to another Mac

- ▶ Use the Finder to copy the project file to the other computer (for example, using AirDrop). The file contains all the necessary information to use the project on another computer.

On the target computer, double-click the file to open it. The project will not appear under Recent Projects until it has been opened.

Note that older Lightkey versions may not be able to open projects created by newer versions, because they contain new features which previous versions don't know about. If you want to move a project back and forth between computers you should therefore use the same Lightkey version on both.

## Search a project

Lightkey lets you easily and quickly search the contents of the current project. This includes:

- fixtures and fixture properties,
- items in the Preset Palette,
- cues and other items in the Live view.

You can also “filter” the content of the Preset Palette and a cuelist so that only items whose name contains the search text are shown.

## Find items in a project



- 1 Do one of the following:
  - ▶ Click  in the toolbar.
  - ▶ Choose Edit → Find... (or press Command-Option-F).

A search field appears near the right end of the toolbar.



- 2 Make sure the placeholder text in the search field reads Search Project. If not, click the  symbol in the field and choose Entire Project from the menu.
- 3 Enter the text to search for in the search field. As you type a list of results appears.
- 4 Click a result to select it in the project.

★ **Tip:** You can use the Up/Down Arrow keys to select search results, and the Return key to select a result in the project. Press Esc to hide the search results.

## Filter items in the Preset Palette

- 1 Reveal the search field in the toolbar, as described above.
- 2 Click the  symbol in the search field and choose Preset Palette from the menu.
- 3 Enter the text to search for in the search field. As you type the Preset Palette is filtered accordingly.
- 4 To remove the filter click  in the search field.

## Filter items in a cuelist

- 1 Reveal the search field in the toolbar, as described above.
- 2 Click the  symbol in the search field and choose Cuelist from the menu. This option is only available if the current Live view page contains a cuelist.
- 3 Enter the text to search for in the search field. As you type the cuelist is filtered accordingly.
- 4 To remove the filter click  in the search field.

## Undo changes

As you work with Lightkey, you can undo most of the changes you can do to a project. This includes changes to the Preview, presets, sequences, cues, effects, the Live view, and even fixture properties. You can also redo actions that you have undone.

### Undo or redo changes

- ▶ To undo the last action, choose Edit → Undo (or press Command-Z).
- ▶ To redo the last action you undid, choose Edit → Redo (or press Command-Shift-Z).

# Chapter 6

## The Lightkey window

This chapter introduces the user interface that's shown once you open a project. All the controls you need are united in a single, well-arranged window. The dark user interface has been specially designed for low-light environments.

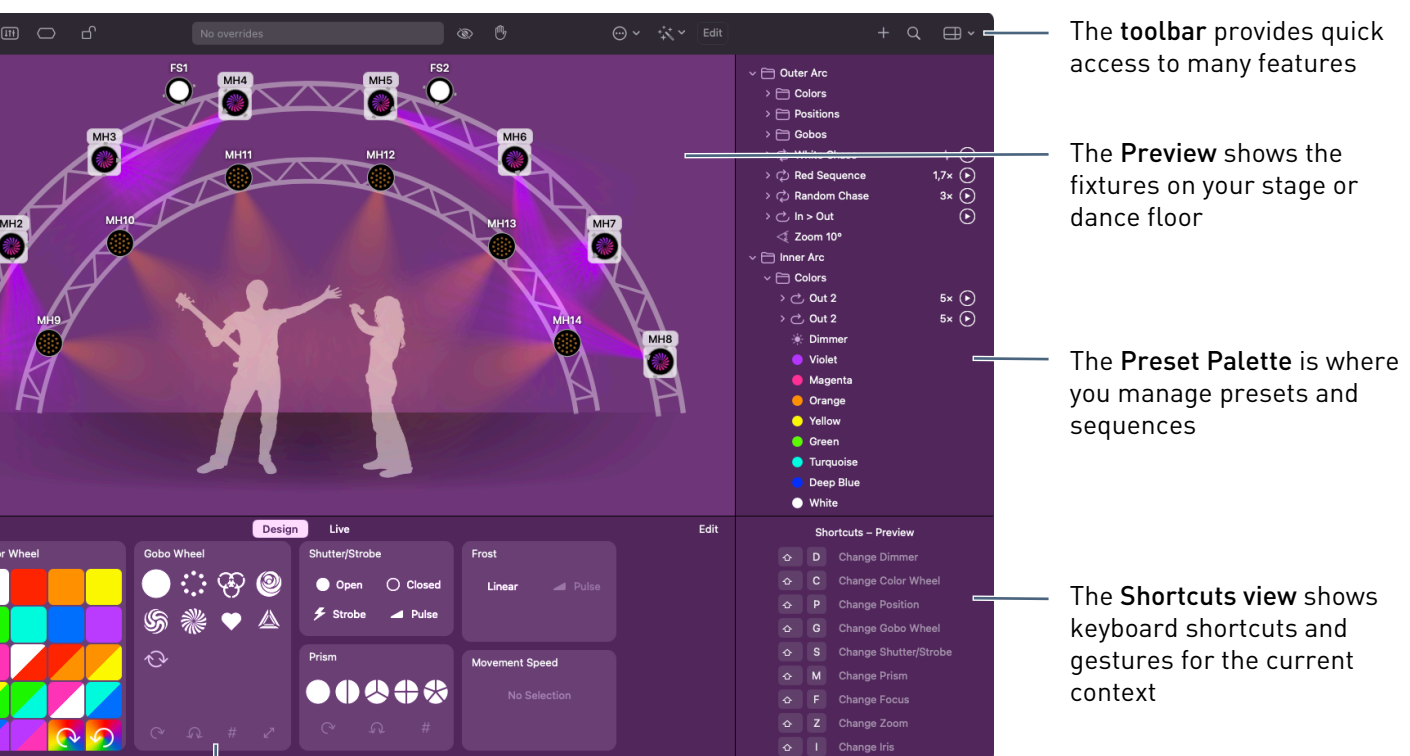

The **toolbar** provides quick access to many features

The **Preview** shows the fixtures on your stage or dance floor

The **Preset Palette** is where you manage presets and sequences

The **Shortcuts view** shows keyboard shortcuts and gestures for the current context

The **Design view** lets you change the properties of the selected fixtures. The properties you see here depend on the selected fixtures.

## Toolbar

The toolbar at the top of the window shows the current project's name and provides quick access to frequently-used functions. The items in the toolbar change depending on the current context. Here's how the toolbar looks once you open a project:

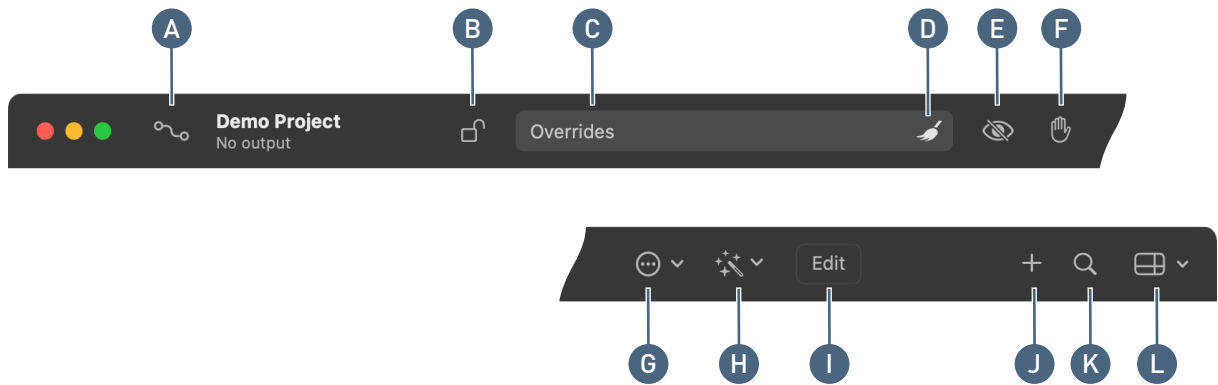

---

**A** Manage fixtures

---

**B** Lock or unlock Lightkey

---

**C** Show the overridden fixture properties

---

**D** Clear the overridden fixture properties

---

**E** Enter or exit blind mode

---

**F** Freeze or unfreeze output

---

**G** Show actions for the selected fixtures

---

**H** Add an effect for the selected fixtures

---

**I** Edit the Preview

---

**J** Add a preset (hold down the mouse button to add sequences or groups)

---

**K** Search the project

---

**L** Show view options

---

## Customize the Lightkey window

You can show or hide parts of Lightkey's window depending on your needs: For example, during a live show you may want to switch to the Live view and hide the Preset Palette. You may even hide the Preview entirely to have more space for the Live view. Or you may want to hide the Shortcuts view once you're familiar with the shortcuts.

### Switch between the Design and Live view

Do one of the following:

- ▶ Click Design or Live below the Preview.
- ▶ Choose View → Design (or press Command-D) to show the Design view. Choose View → Live (or press Command-L) to show the Live view.

### Hide or show the Preview

Do one of the following:

- ▶ Click  in the toolbar and choose Hide/Show Preview from the menu.
- ▶ Choose View → Hide/Show Preview (or press Command-Shift-R).

❖ **Note:** The Design view isn't available when the Preview is hidden because there's no way to select fixtures.

### Hide or show the Preset Palette

Do one of the following:

- ▶ Click  in the toolbar and choose Hide/Show Preset Palette from the menu.
- ▶ Choose View → Hide/Show Preset Palette (or press Command-Shift-P).

### Hide or show the Shortcuts area

Do one of the following:

- ▶ Click  in the toolbar and choose Hide/Show Shortcuts from the menu.
- ▶ Choose View → Hide/Show Shortcuts (or press Command-Shift-S).

## Resize the parts of the window

- ▶ Drag one of the dividers between the parts.

## Full screen view

Lightkey's user interface is ideally suited for the macOS full screen view. By default, the window expands to the entire screen when you open a project and shrinks back to a window when you close a project.

In full screen view, move the pointer to the top of the screen to show the menu bar.

## Zoom the Lightkey window to the full screen

Do one of the following:

- ▶ Click the green zoom button in the top-left corner of the window.
- ▶ Choose View → Enter Full Screen (or press Command-F).

## Return to regular view

Do one of the following:

- ▶ Move the pointer to the top of the screen, then click the green zoom button in the top-left corner.
- ▶ Choose View → Exit Full Screen (or press Command-F).

## Change the behavior when opening and closing a project

- 1 Choose Lightkey → Settings... (or press Command-Comma) and then click General.
- 2 Select "Enter full screen when opening a project" to automatically expand the window to the entire screen when you open a project and shrink it back when you close the project.

## Dual windows

If you have a second display connected to your computer, you can place the Preview on one display and the Live view on the other. You can also use an iPad as a second display for the Live view using apps like Duet or Luna Display.



### Show the Live view on a second display

- 1 Choose View → Dual Windows.  
The Live view appears in a second window titled Live.
- 2 Drag the Live window to the second display.
- 3 Click in the Live window to make sure it's selected, then choose View → Enter Full Screen to expand the window to the full screen.

Lightkey restores the two windows on their respective screens when you quit and reopen the application. To return the Live view to the main window, choose View → Single Window.

## Adaptive background color

By default, the background of Lightkey's window adapts itself to the predominant light color.

### Change the adaptive background color

- 1 Choose Lightkey → Settings... and then click General.
- 2 Select or deselect "Adaptive background color".



## Lock Lightkey

You can protect your projects and settings against changes with a password or Touch ID (if available on your Mac). Only people who know the password can:

- edit presets, sequences, or cues,
- patch fixtures and universes,
- edit external control configurations,
- open the Settings window.

### Lock Lightkey with a password

- 1 Click  in the toolbar or choose Lightkey → Lock.
- 2 In the dialog that appears, enter a password in the Password field, then enter it again in the Verify field.
- 3 Enter a hint to help you remember the password. The hint appears if you enter the wrong password three consecutive times.
- 4 Select “Allow unlocking with Touch ID” to allow unlocking Lightkey with your fingerprint (if Touch ID is available on your Mac).
- 5 Click Lock.

Note that the lock icon in the toolbar is now closed.

### Unlock Lightkey

- 1 Click  in the toolbar or choose Lightkey → Unlock...
- 2 Enter your password and click Unlock, or place your finger on the Touch ID sensor.

Note that the lock icon in the toolbar is now open. Lightkey remains unlocked until you quit the application or lock it again.

### Lock Lightkey again

- ▶ Click  in the toolbar or choose Lightkey → Lock.

### Permanently remove the password protection

- 1 Choose Lightkey → Remove Lock.
- 2 Enter your password (only if Lightkey is currently locked).

## Keyboard shortcuts and gestures

Lightkey provides many keyboard shortcuts and Multi-Touch gestures to help you work faster. The Shortcuts view in the lower-right shows you the most relevant shortcuts for the current context. You can find an overview of the built-in shortcuts and gestures in appendix 2, [Shortcuts and gestures](#).

You can also define your own keyboard shortcuts. See chapter 16, [External control](#), for more information.

# Chapter 7

## Preview

---

The centerpiece of Lightkey's user interface is a 2D view of your lighting installation. You can extend it from simple fixture icons to a visual representation of your venue, complete with virtual light beams.

You begin creating the Preview when you first set up your project, as described in chapter 4, [Set up your lights](#), but you can always come back and complement it later. Lightkey includes a flexible graphics editor which lets you create a detailed view of your venue quickly and effortlessly. This chapter covers all tools and techniques for building the Preview.

The Preview is part of a project. In this chapter we assume that a project is already open.

### **Edit the Preview**

Before you can change the objects in the Preview, you must put the Preview into edit mode. The remainder of this chapter assumes that the Preview is in edit mode.

#### **Enter or exit edit mode**

Do one of the following:

- ▶ To enter edit mode, click Edit in the toolbar. To exit edit mode, click Done.
- ▶ Choose View → Edit Preview (or press Command-J).

- ▶ Control-click a blank part of the Preview and choose Edit Preview from the shortcut menu.
- ▶ Hold down the Command key and double-click a blank part of the Preview.

While the Preview is in edit mode, a grid is shown in the background which helps you to align objects. You can hold down the Space bar and drag to pan the Preview area. On the right of the window is the **Inspector** where you can change the properties of the selected objects.

## Edit objects

The Preview contains various types of objects: Fixture icons, shapes (such as rectangles, ovals, lines, and trusses), text, and images. This section covers basic editing techniques common to all objects.

## Select objects

Before you make changes to objects in the Preview you need to select them.

### Select or deselect objects

- ▶ To select a single object, click anywhere on the object.
- ▶ To select additional objects, hold down the Shift key and click each object.
- ▶ To remove an object from the selection, hold down the Shift key and click the selected object.
- ▶ To select a fixture that is part of a group, double-click the fixture.
- ▶ To select multiple objects at once, press the mouse button over a blank part of the Preview and drag it over the objects. (Hold down the Option key to select outward from the starting point.)
- ▶ To add or remove multiple objects to/from the selection, hold down the Shift key, press the mouse button over a blank part of the Preview, and drag it over the objects.
- ▶ To select all objects in the Preview, choose Edit → Select All (or press Command-A).
- ▶ To deselect all objects in the Preview, choose Edit → Deselect All (or press Command-Shift-A or Esc) or click a blank part of the Preview.

## Move objects

All objects in the Preview can be moved freely. You can scroll in any direction if you need more space. When you exit edit mode, Lightkey adjusts the size of the Preview to fit all objects in the available space.

### Move objects within the Preview

- ▶ Press the mouse button over an object and drag it to a new location. To move multiple objects, select the objects and then drag them to a new location.

As you drag, Lightkey shows smart alignment and spacing guides that help you to precisely align objects.

- ▶ To disable alignment and spacing guides, hold down the Control key as you drag.
- ▶ To constrain the motion to horizontal or vertical, drag the object(s) while holding down the Shift key.
- ▶ To move objects in small steps, select the objects and press one of the arrow keys. To move objects in larger steps, hold down the Shift key while pressing an arrow key.

## Align objects

You can quickly align objects so they line up along a horizontal or vertical axis.

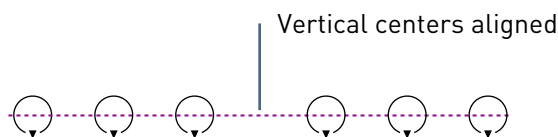

### Align objects

- 1 Select the objects you want to align.
- 2 Do one of the following:
  - ▶ Choose Layout → Align and then choose one of the options in the submenu.
  - ▶ Click  in the toolbar and choose one of the options in the menu.
  - ▶ Control-click one of the objects and choose one of the options in the Align submenu of the shortcut menu.

## Space objects evenly

You can quickly position objects with even spacing on the horizontal or vertical axis.

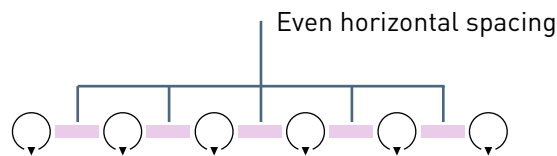

## Space objects evenly

- 1 Select the objects.
- 2 Do one of the following:
  - ▶ Choose Layout → Distribute and then choose one of the options in the submenu.
  - ▶ Click  in the toolbar and choose one of the options in the menu.
  - ▶ Control-click one of the objects and choose one of the options in the Distribute submenu of the shortcut menu.

## Resize and rotate objects

Resizable objects show handles when they are selected. You can resize multiple objects of the same kind at once. Some fixtures can't be resized and have no handles.

### Resize one or more objects

- ▶ Select one or more objects and then drag one of the blue selection handles. To resize objects in one direction, drag a side handle instead of a corner handle.
- ▶ To resize objects from their center, press the Option key as you drag.
- ▶ To constrain a rectangle or oval to a square or circle, hold down the Shift key as you drag.
- ▶ To constrain a curved truss to a circle segment, hold down the Shift key as you drag.
- ▶ To constrain a line's or straight truss's angle to 45°, hold down the Shift key as you drag.
- ▶ Some objects maintain their proportions when resized. To resize those objects disproportionately, hold down the Command key as you drag.

- ▶ To disable alignment and spacing guides, hold down the Control key while you resize objects.

Rectangles, rounded rectangles, ovals, triangles, images, and LED matrixes can also be rotated freely. You can rotate multiple objects at once.

### Rotate an object

- 1 Select one or more objects.
- 2 Hold down the Command key and drag one of the blue selection handles around it. Hold down Shift to constrain the angle to 45°.

## Edit fixtures

This section discusses editing actions which pertain to fixtures.

### Size and rotate fixture icons

LED fixtures can be represented in various ways, depending on the number of beams and their arrangement (as defined by the fixture profile) and the shape you choose for their icon. You can freely edit their shape and change the icon size to reflect the physical LED strip. Here are various types of icons for LED fixtures:

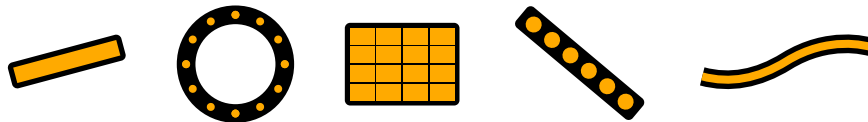



You can also change the size and orientation of PAR or moving head arrays.



### Change the icon size of LED strips and matrixes

- 1 Select one or more LED fixtures.
- 2 Click one of the two size options in the Inspector.

### Change between a line and a ring

- 1 Select one or more LED strips.
- 2 Click either the line  or ring  option in the Inspector.

## Flip LED fixtures horizontally or vertically

- 1 Select one or more LED fixtures.
- 2 Do one of the following:
  - ▶ Click  or  in the toolbar.
  - ▶ Click one of the fixtures' name and choose Flip Horizontally or Flip Vertically from the shortcut menu.
  - ▶ Choose Layout → Flip Horizontally or Flip Vertically.

## Edit the shape of an LED strip

- 1 Select one or more LED strips.
- 2 Click Edit Shape in the Inspector or press Return.
- 3 Use the yellow handles to change the shape:
  - ▶ To select a single handle, click the handle.
  - ▶ To select multiple handles, press the mouse button over a blank part of the Preview and drag across the handles.
  - ▶ To toggle a handle's selection state, hold down the Command key and click the handle.
  - ▶ To select a range of handles, click the first handle, then hold down the Shift key and click the last handle in the range.
  - ▶ To select the handles one by one, press Control-Tab. Press Control-Shift-Tab to reverse the order.
  - ▶ To move the selected handles, drag them. You can also press the Arrow keys.
  - ▶ To add a handle, place the pointer in between two yellow handles, then click the white handle that appears in between them.
  - ▶ To remove the selected handles, choose Edit → Delete or press the Delete key.
- 4 To end editing the shape, press Return or click in the empty area outside the LED strip.



## **Position fixture names**

You can reposition the name tags of fixtures to prevent them from overlapping with other objects.

### **Move a fixture's name tag**

- ▶ Drag the name tag to a position near the fixture's icon.

## Set beam directions

Moving lights, PARS, and similar fixtures are represented by round icons in the Preview. For moving lights, an arrow indicates the current pan position:



Lightkey needs some information about the positions of your moving and static lights to match what you see on the screen with the actual fixture. This is called **calibration**.

### Calibrate the position of a moving light

- 1 Click the fixture icon to select it.
- 2 Do one of the following:
  - ▶ Click Beam Direction... in the Inspector.
  - ▶ Click the fixture's name and choose Beam Direction... from the shortcut menu.
  - ▶ Choose Layout → Beam Direction... (or press Command-Shift-Option-P).
- 3 Follow the instructions and click Next after each step, or Done after the last step.
  - ▶ **Home:** This step tells Lightkey in which direction the fixture is pointing. The fixture moves to the center of its pan range—the home angle—and tilts by 90°.

Imagine you're looking through the base of the moving light in the direction of the pan axis. Drag the arrow until it points in the direction of the light beam.

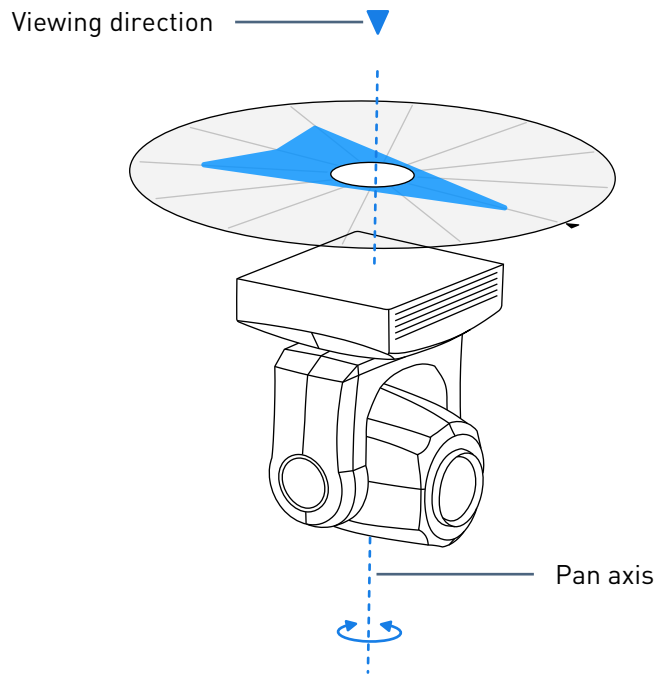

- ▶ **Rotation:** This step tells Lightkey in which direction the fixture's yoke turns. The light performs a slow pan movement, then turns back in blackout and repeats the movement.

The rotating arrow should follow the direction of the light beam. If necessary, click the arrow to reverse its direction.

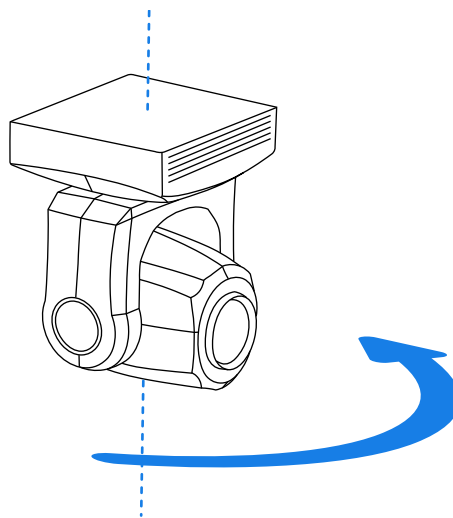

- ▶ **Limits:** This step is optional. It allows you to limit the allowed ranges for pan and tilt. This can be useful, for example, to prevent a light from pointing directly at a wall behind it or into the DJ booth.

Drag the handles to reduce the allowed ranges for pan and tilt.

- ▶ **Perspective:** This step is important to make the virtual light beams match the fixture. The fixture moves to the center of its pan and tilt ranges so it's pointing away from its base.

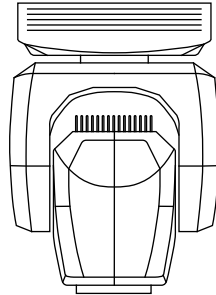

Consider the Preview on the screen. Select the direction to which the light beam is currently pointing—to the left or right, up or down, or parallel to the viewing direction. For example, if the light is suspended from the ceiling and the Preview shows the stage from the front, as in the image above, select the “down” direction at the top. If the light points either towards the viewer or away from the viewer, select the center option.

When calibration is complete, a checkmark appears below the fixture icon.

❖ **Note:** Lightkey needs to know a moving light's pan and tilt ranges to match its beam direction. This information is part of the fixture profile. Some moving lights let you choose between different pan/tilt ranges in their device settings. In this case, always select the largest possible range, because this is what the fixture profile uses.

### Calibrate the position of a static light

- 1 Click the fixture icon to select it.
- 2 Do one of the following:
  - ▶ Click Beam Direction... in the Inspector.
  - ▶ Click the fixture's name and choose Beam Direction... from the shortcut menu.
  - ▶ Choose Layout → Beam Direction... (or press Command-Shift-Option-P).
- 3 Follow the instructions, then click Done.

★ **Tip:** Select multiple fixtures of the same type to set their beam directions at once (assuming they point in the same direction).

## Set beam colors

For fixtures with a fixed color that can't be changed through DMX—such as a PAR with a color gel—you can choose the color of the virtual light beam. The color is also displayed as a dot inside the fixture icon.

### Set a fixture's beam color

- 1 Click the fixture icon to select it.
- 2 Do one of the following:
  - ▶ Click Beam Color... in the Inspector.
  - ▶ Click the fixture's name and choose Beam Color... from the shortcut menu.
  - ▶ Choose Layout → Beam Color... (or press Command-Shift-Option-C).
- 3 Choose a color.

★ **Tip:** Select multiple fixtures to set their beam colors at once.

## Group fixtures

Grouped fixtures can be quickly selected at once, although it is still possible to select them individually. You should group fixtures with the same type and in the same location—for example, a row of blinders above the stage.

### Create a fixture group

- 1 Select the fixtures to group.
- 2 Do one of the following:
  - ▶ Click  in the toolbar.
  - ▶ Control-click one of the fixtures and choose Group from the shortcut menu.
  - ▶ Choose Layout → Group (or press Command-Option-G).

## Ungroup grouped fixtures

- 1 Select the fixture group.
- 2 Do one of the following:
  - ▶ Click  in the toolbar.
  - ▶ Control-click one of the fixtures in the group and choose Ungroup from the shortcut menu.
  - ▶ Choose Layout → Ungroup (or press Command-Option-G).

## Locate fixtures

If you are not sure which fixture a particular icon belongs to, you can use Highlight Mode. When Highlight Mode is enabled, the selected fixture(s) will light up. This works for both DMX fixtures and smart lights.

### Enable Highlight Mode

- ▶ Click  in the toolbar or choose Layout → Highlight Mode (or press Command-Shift-H).

## Disable fixtures or hide light beams

If a fixture is temporarily disconnected, broken, or simply not in use, you can disable it in Lightkey. A disabled fixture shows no light beam, can't be selected in the Preview, and all its DMX channels are set to zero.

You can also tell Lightkey to hide a fixture's virtual light beam.

### Disable or enable a fixture

- ▶ Select one or more fixtures and click Disable in the Inspector.

If multiple fixtures are patched to the same DMX address, you can disable each one individually. When all fixtures are disabled, the corresponding DMX channels are set to zero.

❖ **Note:** You can also disable or enable fixtures in the Fixture Manager. See [Disable fixtures](#) in chapter 13, [Manage DMX fixtures](#).

## Hide the virtual light beam

- ▶ Select one or more fixtures and click “Hide light beam” in the Inspector.

## Add or remove fixtures

You can add or remove fixtures in the Fixture Manager. You can also add multiple icons in the Preview for a single fixture, which is useful if you patched several identical fixtures to the same DMX address. See chapter 13, [Manage DMX fixtures](#), for more information.

## Edit shapes, images, and text

This section discusses editing actions which pertain to shapes, built-in or custom images, and text labels. Shapes include rectangles, rounded rectangles, ovals, triangles, lines, and various types of trusses.

### Add shapes, images, or text

Use the icons on the right side of the window to add objects.

#### Add an object

Do one of the following:

- ▶ Click either Shapes or Images, then drag an object to the desired position in the Preview.
- ▶ Choose Layout → Insert and then choose one of the options in the submenu.

#### Add a custom image

Do one of the following:

- ▶ Choose Layout → Insert Image File..., then select an image file and click Insert.
- ▶ To add an image from another application, copy the image to the Clipboard, go to Lightkey, and choose Edit → Paste.
- ▶ Drag an image file from the Finder to the Preview area and position it where you want it.

## Add text

Do one of the following:

- ▶ Click Shapes, then place the pointer over the T icon and drag it to the desired location in the Preview.
- ▶ Choose Layout → Insert → Text.

Double-click the text label to begin editing, then type. To start a new line, press Option-Return. Click outside the text label or press Return to finish editing.

To edit an existing text label, double-click the text label or select it and press Return.

[Change text formatting](#) later in this chapter describes how to change the style for new text items.

## Copy and paste shapes, images, and text

You can copy shapes, images, and text labels to the Clipboard and paste them again later, as common in many Mac apps. You can also copy and paste images between applications.

### Cut or copy an object

Do one of the following:

- ▶ Select the object(s) and choose Edit → Cut or Edit → Copy (or press Command-X or Command-C).
- ▶ Control-click the object and choose Cut or Copy from the shortcut menu.

### Paste objects from the Clipboard

Do one of the following:

- ▶ Choose Edit → Paste (or press Command-V).
- ▶ Control-click anywhere in the Preview and choose Paste from the shortcut menu.

## Duplicate shapes, images, and text

- ▶ Select the object(s) and choose Edit → Duplicate (or press Command-Shift-D).
- ▶ Control-click an object and choose Duplicate from the shortcut menu.
- ▶ Hold down the Option key while you drag an object.



- ▶ Hold down the Option key and press one of the arrow keys. The new object will be offset from the original by one unit in the arrow direction.

## Delete shapes, images, and text



- ▶ Select the object(s) and press the Delete key.

If you accidentally deleted an object, choose Edit → Undo Delete.

## Flip shapes and images

Lines, some trusses, and images can be flipped on the horizontal or vertical axis.

### Flip objects horizontally or vertically

- 1 Select one or more objects.
- 2 Do one of the following:
  - ▶ Click  or  in the toolbar.
  - ▶ Control-click the object and choose Flip Horizontally or Flip Vertically from the shortcut menu.
  - ▶ Choose Layout → Flip Horizontally or Flip Vertically.

## Order shapes, images, and text

The order or layering of shapes, images, and text determines whether objects appear above or below other objects. Note that fixtures always appear on top of other objects.

### Change the order of objects

- 1 Select one or more objects.
- 2 Do one of the following:
  - ▶ Choose Layout → Order and then choose one of the options in the submenu.
  - ▶ Click  in the toolbar and choose one of the options in the menu.
  - ▶ Control-click one of the objects and choose one of the options in the Order submenu of the shortcut menu.

## Change the style of shapes and images

You can change attributes like fill color, stroke width, stroke color, and opacity for shapes and images.

### Change the style of a shape or built-in image

- 1 Select one or more shapes and images.
- 2 Use the Inspector to change the fill color, stroke width, and stroke color. You can also use custom colors.

### Change the opacity of a custom image

- 1 Select the image.
- 2 Use the Opacity slider in the Inspector to change the image opacity.

## Adjust shape features

Some shapes have specific features which you can change with special selection handles.

### Adjust the corner radius of a rounded rectangle

- 1 Select the rounded rectangle.
- 2 Drag the green selection handle near its top-left corner.

### Edit the shape of a line

- 1 Select a line.
- 2 Click Edit Shape in the Inspector or press Return.
- 3 Use the yellow handles to change the shape:
  - ▶ To select a single handle, click the handle.
  - ▶ To select multiple handles, press the mouse button over a blank part of the Preview and drag across the handles.
  - ▶ To toggle a handle's selection state, hold down the Command key and click the handle.
  - ▶ To select a range of handles, click the first handle, then hold down the Shift key and click the last handle in the range.

- ▶ To select the handles one by one, press Control-Tab. Press Control-Shift-Tab to reverse the order.
- ▶ To move the selected handles, drag them. You can also press the Arrow keys.
- ▶ To add a handle, place the pointer in between two yellow handles, then click the white handle that appears in between them.
- ▶ To remove the selected handles, choose Edit → Delete or press the Delete key.

4 To end editing the line, press Return or click in the empty area outside the line.

### Change the starting or ending angle of a curved truss

- 1 Select the curved truss.
- 2 Drag one of the green selection handles at each end. Hold down the Shift key as you drag to constrain the angle to 45°.

### Change text formatting

You can change fonts, font sizes, and other text attributes like in many other Mac applications.

#### Change the formatting of a text label

- 1 Select one or more text labels. To change only a part of the text, double-click a text label and select the desired range.
- 2 Do one of the following:
  - ▶ Click Show Fonts in the Inspector or choose Edit → Font → Show Fonts. Select a font, font size, and other options in the Font window.
  - ▶ Choose Edit → Font → Bold, Underline, Italic to change the text style.
  - ▶ Click Show Colors in the Inspector or choose Edit → Font → Show Colors, then select a color in the Color window.
  - ▶ Choose Edit → Alignment, then choose one of the options in the submenu to change the alignment of the label.

You can change the default font and style for new text labels. Each project has its own default style for text labels.

### **Set the default style for new text labels**

- 1** Select a single text label whose style you want to become the new default.
- 2** Do one of the following:
  - ▶ Choose Edit → Set Default Style.
  - ▶ Control-click the label and choose Set Default Style from the shortcut menu.

### **Reset the default style to the original state**

- 1** Select a single text label.
- 2** Hold down the Option key and choose Edit → Reset Default Style.

# Chapter 8

## Fixture properties

---

A fixture property comprises one or more features of a fixture that can be controlled through DMX—for example, Dimmer, Color, and Position. This chapter describes how you change these properties in Lightkey.

Changing a fixture property generally involves two steps:

- select one or more fixtures, or one or more individual light beams,
- change a property of the fixtures or light beams.

When you assign a value to a fixture property, the property is **defined** or **overridden**. A blue dot to the left of the fixture name indicates that at least one property has been defined.

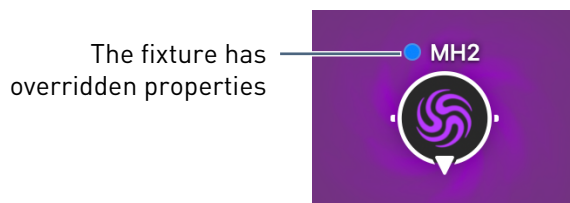

You can define fixture properties for multiple fixtures at once, even if the fixtures are of different types. Lightkey will do its best to find the closest matching value for each individual fixture.

## Select fixtures

There are many ways to select fixtures using the keyboard, mouse, and external control hardware. They are described in this section. A frame around the icon indicates that a fixture is selected.

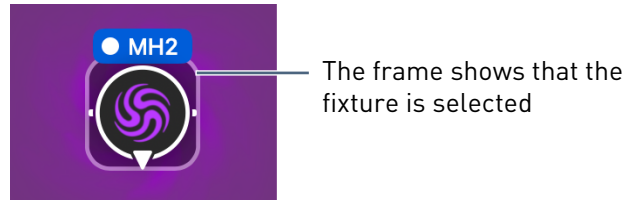

❖ **Note:** If a fixture has been disabled it can't be selected.

## Select all fixtures

You can quickly select or deselect all fixtures in the project.

### Select or deselect all fixtures

- ▶ To select all fixtures, choose Edit → Select All (or press Command-A).
- ▶ To deselect all fixtures, choose Edit → Deselect All (or press Command-Shift-A or Esc) or click a blank part of the Preview.

## Select fixtures by location

You can select or deselect fixtures by their location in the Preview.

### Select or deselect fixtures by location

- ▶ To select a single fixture, click its icon.
- ▶ To select all fixtures in a group, click the icon of one of the fixtures. To select an individual fixture in a group, double-click its icon.
- ▶ To select additional fixtures, hold down the Shift key and click each fixture.
- ▶ To remove a fixture from the selection, hold down the Shift key and click the selected fixture.
- ▶ To select multiple fixtures at once, press the mouse button over a blank part of the Preview and drag it over the fixtures. (Hold down the Option key to select outward from the starting point.)

- ▶ To add or remove multiple fixtures to/from the selection, hold down the Shift key, press the mouse button over a blank part of the Preview, and drag it over the fixtures.
- ▶ To select the nearest fixture in any direction, press one of the arrow keys.
- ▶ To extend the fixture selection in any direction, hold down the Shift key and press one of the arrow keys.

## Select fixtures by type

When a single fixture is selected, you can quickly extend the selection to all other fixtures of the same type (for example, all moving heads or all blinders).

### Select fixtures by type

- 1 Select a single fixture.
- 2 Choose Edit → Select All [fixture type] (for example, Select All Moving Heads) (or press Command-Option-A).

## Select fixtures by name

You can quickly select a fixture by typing its short name, or select multiple fixtures by typing a common prefix of their short names. You can also step through fixtures in alphabetical order.

### Select fixture(s) by their short name

- ▶ Type one or more letters or numbers. Do not use the Shift key or any other modifier keys.

**Example:** Suppose your rig consists of moving heads and PARs, arranged like this:



Here are examples how you can select these fixtures using type selection:

Type this...	... to select these fixtures
M	All moving heads
MH2	MH2
P	All PARs
PL	PARs on the left (PL1-3)
PR	PARs on the right (PR1-3)
P1	Outmost PARs

### Step through fixtures by their short name

- ▶ To select the next fixture in alphabetical order, press Control-Tab.
- ▶ To select the previous fixture in alphabetical order, press Control-Shift-Tab.

### Select fixtures through external control

You can set up bindings to select fixtures through DMX-In, MIDI, or custom keyboard shortcuts. See chapter 16, [External control](#), for more information.





### Select light beams

Some fixtures have multiple light beams which can be controlled individually—for example, an LED matrix or a scanner with multiple heads. To change properties for individual beams, you first select the beam(s) and then change the fixture properties.

Some fixtures have groups of beams which always share the same properties. This depends on the fixture profile and the selected mode. In this case selecting one beam from a group will select the others as well.

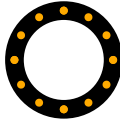

For some types of fixtures the icon in the Preview shows the individual beams:

 LED strip with 8 beams	 LED ring with 12 beams	 LED matrix with 25 beams
 LED bar with 4 segments	 LED PAR with 7 beams	 Moving head array with 4 heads

❖ **Note:** Only the Dimmer, Color, Shutter/Strobe, and Position properties can be defined for individual beams.

### Select one or more light beams

- 1 Select one or more fixtures with multiple light beams.
- 2 If the fixtures' icons show the light beams, do one of the following:
  - ▶ Click one of the beams in the icon of a selected fixture to select it.
  - ▶ To select a range of beams, press the mouse button on a beam and drag the pointer across other beams. Alternatively, click one of the beams, then hold down the Shift key and click another beam: This selects the two clicked beams and all beams in between.
  - ▶ To select an additional beam or remove a beam from the selection, hold down the Command key and click a beam.

For fixtures whose icons don't show the light beams, do one of the following:

- ▶ Click the fixture's name and choose Beams from the shortcut menu, then choose one of the items from the submenu.
- ▶ Choose Fixture → Beams, then choose one of the items from the submenu.
- ▶ To select an additional beam or remove a beam from the selection, hold down the Command key and select a beam as in the previous steps.

## Fixture properties

A **fixture property** comprises one or more features of a fixture that can be controlled through DMX—for example, Dimmer, Color, and Position. There are several places where you control properties of the selected fixture(s):

- The Design view below the Preview (see the image below) controls most fixture properties, for example, Dimmer, Color, and Shutter/Strobe. The Design view adapts itself to the fixtures in the current project: Only properties which are supported by your fixtures are visible, and individual controls may be hidden if they don't apply to your fixtures.
- Heads-up displays (or HUDs) in the Preview control Position, Focus, Zoom, and Iris.
- The fixture's shortcut menu and the menu bar contain commands to control the Lamp and Command properties.

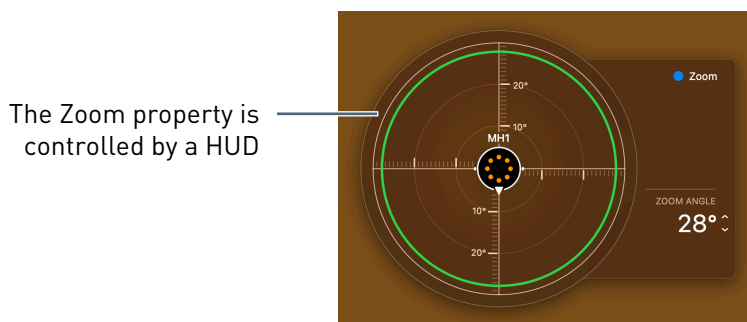
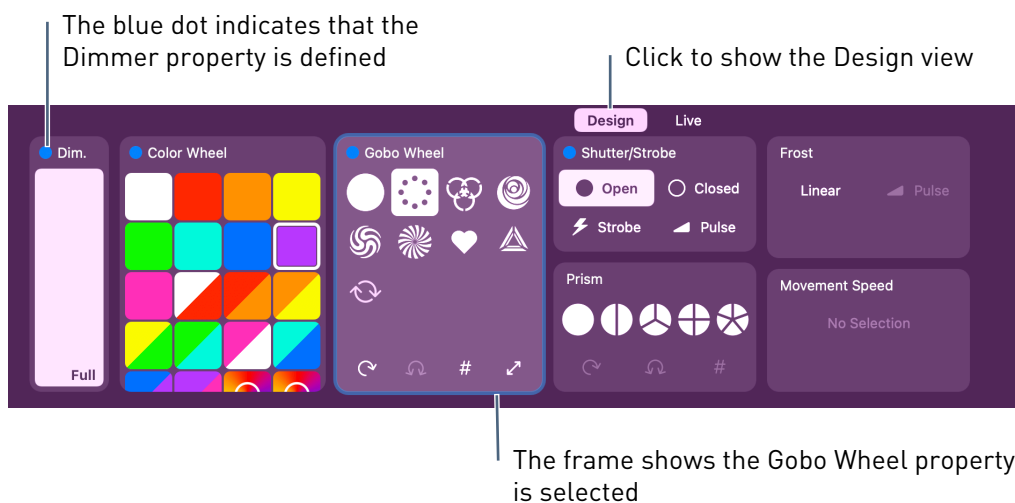

### Show the Design view

Do one of the following:

- ▶ Click Design below the Preview.

- ▶ Choose View → Design (or press Command-D).

## Select a fixture property

Most fixture properties can be selected. While a property is selected, you can use specific keyboard shortcuts to control the property. These shortcuts are listed in the following sections; you also see them in the Shortcuts view when the property is selected. For example, if the Color property is selected, the Shortcuts view's title reads "Shortcuts – Color".

A property with a HUD is selected when the HUD is open.

The Design view shows only properties that pertain to the selected fixtures. If no fixtures are selected in the Preview, the Design view is empty.

❖ **Note:** You can't select properties that have been hidden from the Design view. See [Reorder and hide custom properties](#) below on how to show or hide properties in the Design view.

There are several ways to select fixture properties.

## Select a fixture property

- 1 Select one or more fixtures in the Preview.
- 2 Do one of the following:
  - ▶ Click a fixture's name and select the property from the shortcut menu.
  - ▶ Click ☺ in the toolbar and choose Select Property from the menu, then select a property.
  - ▶ Choose Fixture → Select Property, then select a property from the menu.

Fixture properties in the Design view are automatically selected when you click one of their controls. For example, the Shutter/Strobe property is selected when you click one of the shutter states. The selected property in the Design view has lighter background.

Many fixture properties have a keyboard shortcut (a letter) which selects the property in the Design view or opens the property's HUD. After using the shortcut to select the property, you can use property-specific keyboard shortcuts to change its value. This way you can control most fixture properties solely by using the keyboard.

Fixture property	Shortcut letter
Dimmer	D
Color, Color Wheel	C
Gobo Wheel	G
Shutter/Strobe	S
Position	P
Focus	F
Zoom	Z
Iris	I
Prism	M
Frost	R
Fog	O

### Select a fixture property using keyboard shortcuts

- 1 Select one or more fixtures which support the property.
- 2 Do one of the following:
  - ▶ Hold down the Shift key and press the letter for the fixture property.
  - ▶ Press only the letter for the fixture property until the property is selected in the Design view or until a HUD appears.

### Cycle the fixture properties in the Design view

- 1 Make sure the Design view is visible (see above).
- 2 Select one or more fixtures.
- 3 Press the Tab key to select the next (or first) enabled property in the Design view, or press Shift-Tab to select the previous enabled property.

## Deselect any fixture property

- ▶ Press Return, Enter, or Esc.
- ▶ Click the empty area at the top of the Design view.
- ▶ Click a blank part of the Preview. (This will also deselect all fixtures.)

★ **Tip:** If your Mac has a Touch Bar, you can use it to conveniently control any fixture property. Select the fixture property as described above, then change its value with the Touch Bar.

## Define a fixture property

When you assign a value to a fixture property in the Design view or the property's HUD, the property is said to be **defined** or **overridden**. In this state the property values are applied directly to the fixture and override active presets, sequences, and cues. If a fixture property is not defined, the fixture's state depends on the active presets, sequences, and cues.

The Design view and HUDs reflect the state of the overridden fixture properties for the selected fixtures. Properties that are undefined show no value, even if an active preset or cue contains values for them. Therefore a property such as Dimmer may appear as off in the Design view even though the fixture's dimmer is turned on by an active preset.

A blue dot to the left of a property's name indicates that the property is defined. A gray dot means that that the property is defined for some but not all of the selected fixtures. When you change the value of a property (for example, by dragging the Dimmer slider), the property is automatically marked as defined.

## Clear a defined fixture property

Do one of the following:

- ▶ Click the blue (or gray) dot to the left of the property's name in the Design view or the property's HUD.
- ▶ Select the property and press the Delete key.

For more information see [View overridden fixture properties](#) and [Clear fixture properties](#) later in this chapter.

## Effects

When a fixture property has an effect, its value is defined by the effect. In this case you see an icon in place of the property's controls in the Design view. Click the icon to edit the effect. See chapter 10, [Effects](#), for more information about effects.

### Remove an effect for a fixture property

Do one of the following:

- ▶ Click the blue (or gray) dot to the left of the property's name in the Design view.
- ▶ Select the property and press the Delete key.

## Dimmer

The Dimmer property controls a fixture's intensity (brightness).

### Select the Dimmer property

- 1 Select one or more fixtures which support the Dimmer property.
- 2 Do one of the following:
  - ▶ Click one of the fixtures' names and choose Dimmer from the shortcut menu.
  - ▶ Press Shift-D or press D until the Dimmer property is selected.

The keyboard shortcuts in this section require that the Dimmer property is selected.

### Change a fixture's intensity

Do one of the following:

- ▶ Drag the Dimmer slider in the Design view.
- ▶ Place the pointer over the Dimmer slider and scroll up or down. (If this doesn't work, choose Lightkey → Settings..., click Gestures, and make sure "Scrolling changes slider and HUD values" is selected.)
- ▶ Press the Up/Down Arrow keys or Plus/Minus keys to increase/decrease the intensity by 10%.
- ▶ Hold down the Option key and press the Up/Down Arrow keys or Plus/Minus keys to increase/decrease the intensity by 1%.

- ▶ Type a number to set the intensity to an exact value. (Type a single digit to set the value in steps of 10%. Type two or three digits to set an exact percent value.)
- ▶ Hold down the Command key and scroll up or down while the pointer is over the Preview. (This gesture can be changed in the Settings window. See [Multi-Touch gestures](#) in chapter 16, [External control](#).) The Dimmer property needs not be selected for this.

❖ **Note:** As a convenience, when you select an intensity greater than zero and the shutter state is closed, Lightkey automatically opens the shutter (for fixtures which support the Shutter property).

### Choose how intensities are applied to multiple fixtures

- ▶ Click Dimmer and choose one of the following options from the menu:
  - **Absolute:** All fixtures are assigned the same intensity, regardless of their previous state.
  - **Relative:** This mode maintains the relative distances between the fixtures' intensities. For example, if you increase the intensity by 10%, all fixtures' intensities increase by 10% from the previous value.

You may note that the Dimmer property is also available for fixtures with no explicit Dimmer DMX channel. If a fixture uses the RGB color model (see [Color](#) below), Lightkey will also display the Dimmer property which then affects the color's brightness. This feature has several advantages, for example:

- It allows dimming fixtures of different types at once, whether they have a Dimmer channel or not.
- Fixtures with no explicit Dimmer support are also affected by the Master Dimmer (see below).
- It allows controlling the intensity separately from the color, e.g. in different presets.

### Master Dimmer

Apart from the Dimmer property, the intensity of all fixtures is also affected by the Master Dimmer. You can tell Lightkey to ignore the Master Dimmer for individual fixtures.

## Change the Master Dimmer

Do one of the following:

- ▶ Click Live to show the Live view, then drag the Master Dimmer slider. Alternatively, place the pointer over the slider and scroll up or down. (If this doesn't work, choose Lightkey → Settings..., click Gestures, and make sure "Scrolling changes slider and HUD values" is selected.)
- ▶ Place the pointer over the Preview and swipe up or down with four fingers on your trackpad. (This gesture requires that four-finger gestures are not assigned to other actions in System Settings. It can be changed in the Settings window. See [Multi-Touch gestures](#) in chapter 16, [External control](#).)

❖ **Note:** The Master Dimmer only affects fixtures that can be dimmed.

## Ignore the Master Dimmer for individual fixtures

- 1 Click Edit in the toolbar or choose View → Edit Preview to edit the Preview.
- 2 Select one or more fixtures.
- 3 Click Ignore Master Dimmer in the Inspector on the right.
- 4 Click Done in the toolbar.

## Color

The Color property mixes a fixture's light color by combining a set of three base colors in varying degrees. Traditionally color mixing uses the CMY (Cyan, Magenta, Yellow) model. With the advent of LED fixtures the RGB (Red, Green, Blue) model is becoming common. Some fixtures support additional colors like amber, white, or ultraviolet.

For fixtures that use the CMY or RGB models, the Design view shows a round control comprised of three sliders which control the color's hue (outer ring), saturation (left inner slider), and brightness (right inner slider). Behind the scenes, Lightkey translates these components to the matching RGB or CMY values.

Some fixtures provide additional color components:

- Cool or warm white
- Amber



- Lime
- Ultraviolet

Additional features may include:

- **Color temperature:** The tint of white light, in degrees Kelvin.
- **Green saturation:** The shift from the neutral point to full minus green or full plus green, in percent.
- **Xfade to Color:** Transition between pure white (0%) and full color (100%).

### Select the Color property

- 1 Select one or more fixtures which support the Color property.
- 2 Do one of the following:
  - ▶ Click one of the fixtures' names and choose Color from the shortcut menu.
  - ▶ Press Shift-C or press C until the Color property is selected.

The keyboard shortcuts in this section require that the Color property is selected.

### Choose the color's hue

Do one of the following:

- ▶ Drag the Hue slider in the Design view.
- ▶ Place the pointer over the Hue slider and scroll up or down. (If this doesn't work, choose Lightkey → Settings..., click Gestures, and make sure "Scrolling changes slider and HUD values" is selected.)
- ▶ Press the Up/Down Arrow keys or Plus/Minus keys to increase/decrease the hue by 10°.
- ▶ Hold down the Option key and press the Up/Down Arrow keys or Plus/Minus keys to increase/decrease the hue by 1°.
- ▶ Type a number between 0 and 360 to change the hue.
- ▶ Hold down the Command and Option keys and scroll up or down while the pointer is over the Preview. (This gesture can be changed in the Settings window. See [Multi-Touch gestures](#) in chapter 16, [External control](#).) The Color property needs not be selected for this.

## Choose the color's saturation

Do one of the following:

- ▶ Drag the Saturation slider (left).
- ▶ Place the pointer over the Saturation slider and scroll up or down. (If this doesn't work, choose Lightkey → Settings..., click Gestures, and make sure "Scrolling changes slider and HUD values" is selected.)
- ▶ Press the Left/Right Arrow keys to decrease/increase the saturation by 10%.
- ▶ Hold down the Option key and press the Left/Right Arrow keys to decrease/increase the saturation by 1%.
- ▶ Hold down the Command, Shift, and Option keys and scroll up or down while the pointer is over the Preview. (This gesture can be changed in the Settings window. See [Multi-Touch gestures](#) in chapter 16, [External control](#).) The Color property needs not be selected for this.

## Choose the color's brightness

Do one of the following:

- ▶ Drag the Brightness slider (right).
- ▶ Place the pointer over the Brightness slider and scroll up or down. (If this doesn't work, choose Lightkey → Settings..., click Gestures, and make sure "Scrolling changes slider and HUD values" is selected.)

## Change the color using the system color window

- 1 Click the current color in the center of the color control.

The system color window opens.

- 2 Choose a color in the color window.

## Change additional colors and features

Do one of the following:

- ▶ Drag the sliders next to the main color control, or place the pointer over a slider and scroll up or down. (If no sliders are visible then the selected fixtures don't support these features.)

- ▶ When the Color property is selected, press the Tab key until a border appears around the slider you'd like to change. Then use the Up/Down Arrow keys or type a numeric value to change the slider's value.

You can enlarge the sliders for additional colors and features for more precise control. The enlarged sliders also show the current value for each slider.

### Change the size of the sliders for additional colors/features

- ▶ Click Color and choose Small Sliders or Large Sliders from the menu.

#### Why are my lights blue?

If a fixture's Color property is not defined—that is, it's neither overridden nor defined by any active preset, cue, or sequence—then Lightkey applies its default color. For RGB and CMY fixtures the default color is normally blue. Therefore, if the fixture's Dimmer is open (or it cannot be dimmed), the light color is blue.

You can change the default color to any other color, including black. See [Default values](#) later in this chapter for more information.

## Color Wheel

The Color Wheel property controls a fixture's color wheel, which contains colored gels to create a tinted light beam. Some fixtures have multiple superimposed color wheels; in this case there are multiple Color Wheel properties which you can control independently.

For each color wheel, the Design view shows a grid of the available colors. If multiple fixtures are selected, the grid contains the union of all available colors for the fixtures.

Some fixtures support “special” colors which also appear in the grid:

- “Split colors” are created by stopping the color wheel at a position where two adjacent color gels are in front of the light source.
- Color correction gels appear as “CTO” (Color Temperature Orange) or “CTB” (Color Temperature Blue) and may contain a color temperature in Kelvin.

- Numbers represent “unknown” colors that have not been specified in the fixture profile.
- Some fixtures support “random color” or “sound-controlled color” features. They are represented by icons (cube or musical note, respectively) in the color grid. The exact semantics of these features depend on the fixture.
- Many fixtures can rotate their color wheel continuously, creating a “rainbow effect”. In this case one or two rainbow icons appear at the end of the grid. Most fixtures also allow changing the rotation speed.

### Select the Color Wheel property

- 1 Select one or more fixtures with a color wheel.
- 2 Do one of the following:
  - ▶ Click one of the fixtures’ names and choose Color Wheel from the shortcut menu.
  - ▶ Press Shift-C or press C until the Color Wheel property is selected.

The keyboard shortcuts in this section require that the Color Wheel property is selected.

### Select a color

Do one of the following:

- ▶ Click one of the colors in the grid.
- ▶ Press an arrow key.
- ▶ Type a number to select a color by its index.

If multiple kinds of fixtures are selected and the selected color is not available on all fixtures, Lightkey tries to apply the closest matching color.

### Change the speed of the rainbow effect

- ▶ Press the mouse button over one of the rainbow icons at the end of the color grid, and drag up or down.

## Gobo Wheel

The Gobo Wheel property controls a fixture's gobo wheel. A gobo is a stencil that is placed in front of the light source, projecting an image onto a surface. The term is an acronym for "GOes Before Optics". Similar to a color wheel, multiple gobos are arranged on a wheel so that they can be moved sequentially through the light beam. Some fixtures have multiple superimposed gobo wheels; in this case there are multiple Gobo Wheel properties which you can control independently.

For each gobo wheel, the Design view shows a grid of the available gobos. If multiple fixtures are selected, the grid contains the union of all available gobos for the fixtures.

### Select the Gobo Wheel property

- 1 Select one or more fixtures with a gobo wheel.
- 2 Do one of the following:
  - ▶ Click one of the fixtures' names and choose Gobo Wheel from the shortcut menu.
  - ▶ Press Shift-G or press G until the Gobo Wheel property is selected.

The keyboard shortcuts in this section require that the Gobo Wheel property is selected.

### Select a gobo

Do one of the following:

- ▶ Click one of the gobos.
- ▶ Press an arrow key.
- ▶ Type a number to select a gobo by its index.

### Gobo cycle

Some fixtures support a **gobo cycle** effect which continuously rotates the gobo wheel in clockwise or counterclockwise direction at a fixed or variable speed.

## Apply a gobo cycle effect

- 1 Select the clockwise or counterclockwise gobo cycle effect from the gobo grid (only available if the selected fixtures support gobo cycle).
- 2 Drag the Speed slider to change the cycle speed (only available if the selected fixtures support variable cycle speeds). Alternatively, place the pointer over the slider and scroll left or right.

## Gobo states

Many fixtures support some or all of the following gobo states:

- **Rotation:** Continuous rotation in clockwise or counterclockwise direction.
- **Bouncing:** Continuous rotation with alternating direction.
- **Indexing:** Changes the gobo's angle.
- **Shake:** Rotates the gobo wheel slightly backward and forward.

### Change a gobo's rotation state

- ▶ Click  $\curvearrowright$  or press R to enable rotation. Repeat to reverse the rotation direction, and repeat again to stop the rotation.
- ▶ If the fixture supports gobo rotation with variable speed: Press the mouse button over  $\curvearrowright$  and drag up or down to adjust the speed, or press the Minus/Plus keys. Press Option-Minus or Option-Plus for fine control.

### Change a gobo's bounce state

- ▶ Click  $\curvearrowleft$  or press B to enable bouncing. Repeat to stop the gobo from bouncing.
- ▶ If the fixture supports gobo bouncing with variable speed: Press the mouse button over  $\curvearrowleft$  and drag up or down to adjust the speed, or press the Minus/Plus keys. Press Option-Minus or Option-Plus for fine control.

### Rotate a gobo (indexing)

Do one of the following:

- ▶ Press the mouse button over # and drag up or down to adjust the angle. Click again to disable gobo indexing.
- ▶ Press I to turn indexing on or off. Press the Minus/Plus keys to change the angle; press Option-Minus or Option-Plus for fine control.

## Change a gobo's shake state

- ▶ Click ↗ or press S to enable shake. Repeat to stop the gobo from shaking.
- ▶ If the fixture supports gobo shake with variable speed: Press the mouse button over ↗ and drag up or down to adjust the speed, or press the Minus/Plus keys. Press Option-Minus or Option-Plus for fine control.

❖ **Note:** Rotation, bounce, and indexing are not available for the open gobo.

## Shutter/Strobe

The Shutter/Strobe property can control two slightly different things:

- A fixture's shutter, which can be moved in front of the light source so that no light is emitted. Often the shutter can also be used to create stroboscope (strobe) effects (regular or irregular flashes of light) or pulse effects (gradually increasing the amount of light and abruptly reducing it, or vice versa).
- A stroboscope (strobe) effect, which may or may not be realized through a shutter (it may also be realized by a xenon flash lamp, for example).

### Select the Shutter/Strobe property

- 1 Select one or more fixtures which support the Shutter/Strobe property.
- 2 Do one of the following:
  - ▶ Click one of the fixtures' names and choose Shutter/Strobe from the shortcut menu.
  - ▶ Press Shift-S or press S until the Shutter/Strobe property is selected.

The keyboard shortcuts in this section require that the Shutter/Strobe property is selected.

### Open or close the shutter

Do one of the following:

- ▶ Click Open or Closed.
- ▶ Press O to open or C to close the shutter.

❖ **Note:** As a convenience, Lightkey automatically sets the shutter state to open when you apply a non-zero Dimmer value if the shutter was previously closed.

### Control strobe effects

- ▶ Click Strobe or press S to enable strobing (if supported by the fixture). Repeat to select synchronized strobe, random strobe, random synchronized strobe, or lightning strobe (if supported by the fixture).

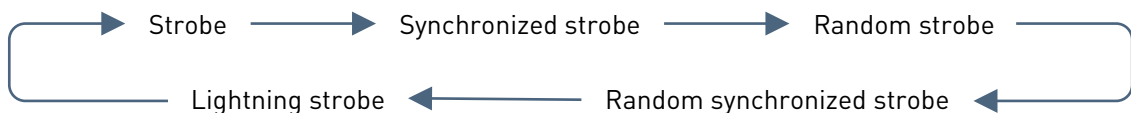

- ▶ Press the mouse over the Strobe button and drag up or down to adjust the strobe speed (if the fixture supports variable strobe speeds).
- ▶ If the fixture supports a sound-controlled strobing, drag the mouse up until the label reads “Sound-Active”.
- ▶ You can also press the Up/Down Arrow keys or Minus/Plus keys to decrease/increase the strobe speed. (Press Option-Up/Down Arrow or Option-Minus/Plus for fine control.)

### Control shutter pulse effects

- ▶ Click Pulse or press P to enable the pulse effect (if supported by the fixture). Repeat to change the pulse style. The button cycles between the following states if they are supported by the selected fixtures:

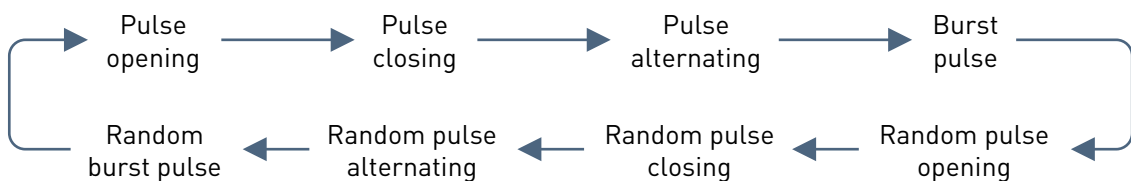

- ▶ Press the mouse over the Pulse button and drag up or down to adjust the pulse speed (if the fixture supports variable pulse speeds).
- ▶ You can also press the Up/Down Arrow keys or Minus/Plus keys to decrease/increase the pulse speed. (Press Option-Up/Down Arrow or Option-Minus/Plus for fine control.)



## Position

Moving heads and scanners can typically rotate around two axes called pan and tilt. Their position is therefore defined by two angles: The **pan angle** describes the rotation of the yoke, and **tilt angle** describes the rotation of the head inside the yoke.

Lightkey visualizes positions in a circular area which reflects the physical direction of the light. The angle around the circle represents pan, and the distance from the center represents tilt. To understand the displayed positions, imagine looking in the direction of the pan axis:

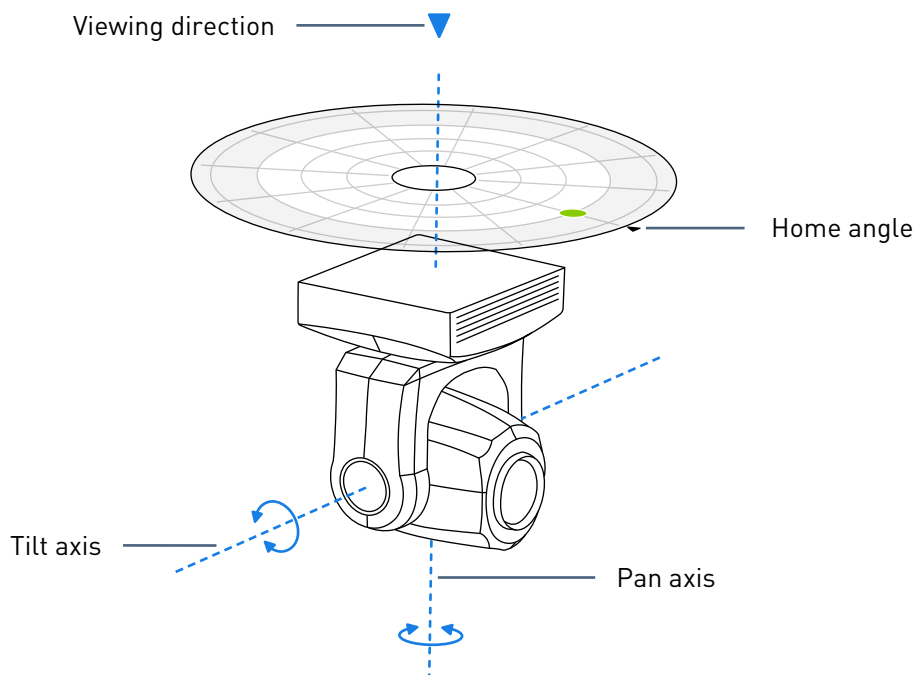

Before you use the position control, you should calibrate the fixture's beam direction, as described in [Set beam directions](#) in chapter 7, [Preview](#). This ensures that the position control and virtual light beams match the physical fixture.

Pan angles are measured from the center of the physical pan range. This position is called the **home angle** and is always at  $0^\circ$ . Pan angles in clockwise direction of the home angle have a negative sign, and angles in counterclockwise direction have a positive sign. Likewise, tilt angles are measured from the center of the tilt range ( $0^\circ$ ). At this position the head is parallel to the yoke, pointing away from the fixture's base.

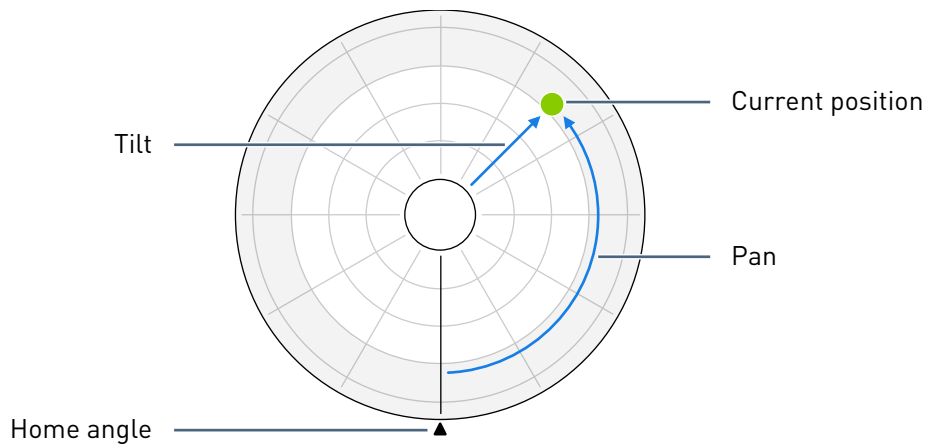

The shaded area at the outside marks tilt angles beyond 90°.

The Position HUD observes any limits you set during calibration for the pan and tilt range. If you limit the pan or tilt range, the 0° positions may no longer be in the center of the selectable range.

A given direction of the light beam can be the result of more than one pan/tilt combination. For example, at pan = -60°, tilt = +45°, the light beam points in the same direction as at pan = +120°, tilt = -45°. This is matched by Lightkey's position control, where both pan/tilt combinations are represented by the same point in the circle:

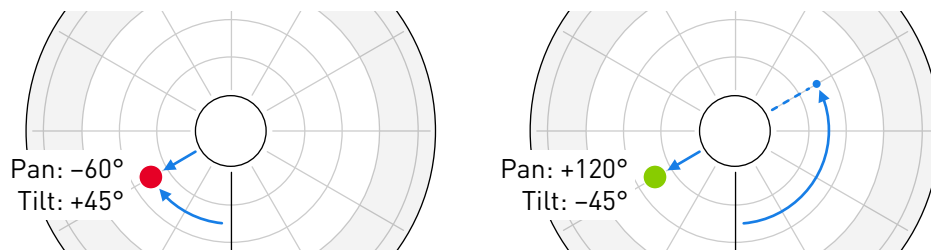

To help distinguish between these cases, positions in the negative pan range appear red and positions in the positive pan range appear green. Positions in the negative tilt range appear in a lighter color.

Many fixtures can pan by more than 360°, so there may be two more pan/tilt combinations which result in the same beam direction:

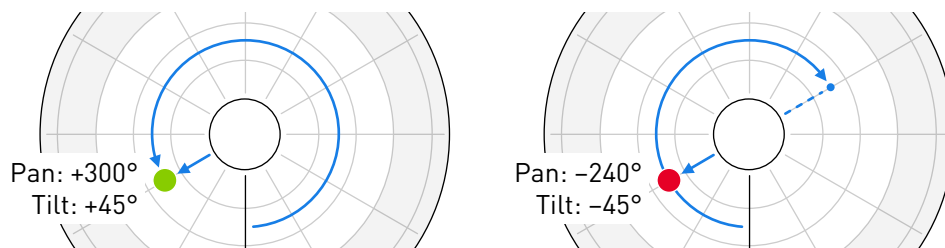

It's important to understand that these are different states, even though the light beam effectively points in the same direction. This becomes apparent when you switch between presets or cues with different positions: For example, if the pan angle changes from  $-60^\circ$  to  $+300^\circ$ , the yoke will make a full turn, even though the light beam ends up in the same direction.

## Open the Position HUD

- 1 Select one or more fixtures which support the Position property.
- 2 Do one of the following:
  - ▶ Click one of the fixtures' names and choose Position from the shortcut menu.
  - ▶ Press Shift-P or press P until the Position HUD appears.

If you have a trackpad which supports Force Touch, you can also force click a fixture icon to open the Position HUD. Otherwise you can press the mouse button over a fixture icon for about 0.5 seconds until the Position HUD appears. These gestures can be configured in Lightkey's Settings window. For more information, see [Multi-Touch gestures](#) in chapter 16, [External control](#).

The following tasks in this section require that the Position HUD is open.

## Change the fixture position

- ▶ Drag the colored dot or click anywhere inside the position control.
- ▶ To disable snapping to some pan/tilt angles, hold down the Control key as you drag.
- ▶ To lock the pan angle, hold down the Command key as you click or drag. To lock the tilt angle, hold down the Shift key as you click or drag.
- ▶ Another way to change only pan or only tilt is to drag the colored triangles next to the pan or tilt scale.
- ▶ To reverse the sign of the pan or tilt angle, Control-click the position control and choose Flip Pan or Flip Tilt from the shortcut menu.
- ▶ To quickly change the fixture position when the Position HUD is not open, press the mouse button while the pointer is over a fixture's icon. When the Position HUD opens, drag the pointer to a point in the position control, then release the mouse button.

You can also change the position with the keyboard, by scrolling, or with a joystick.

### Additional ways to change the fixture position

- ▶ Press one of the arrow keys to move the position in steps of  $1^\circ$ . The Left/Right Arrow keys change pan and the Up/Down Arrow keys change tilt. Hold down the Shift key to move in  $10^\circ$  steps, or the Command key to move in  $0.1^\circ$  steps.
- ▶ Place the pointer over the position control and scroll up or down to change pan. (If scrolling has no effect, choose Lightkey → Settings..., click Gestures, and make sure “Scrolling changes slider and HUD values” is selected.) Hold down the Command key as you scroll to change tilt. Hold down the Shift key to move faster or the Option key to move slower.
- ▶ Press a key on the numeric keypad to select a pan angle according to the location of the key.

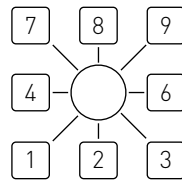

- ▶ You can also control fixture positions with a joystick. The joystick’s horizontal axis controls pan and the vertical axis controls tilt. This works even when the Position HUD is not open. You can adjust the speed in the Gestures tab of the Settings window.

As previously explained, a point in the position control may correspond to multiple pan/tilt combinations, so a click in the HUD may not always result in the desired position. The following techniques let you select all possible pan and tilt angles.

### Change the sign of the pan angle

- ▶ In the position control, drag the dot from the negative range through the home angle to the positive range, or vice versa.
- ▶ Press the Left or Right Arrow key to change the pan angle until its sign changes. (You can hold down the Shift key to increase the steps.)
- ▶ Control-click the position control and choose Flip Pan. This will reverse the sign of the pan angle.

## Change the sign of the tilt angle

Do one of the following:

- ▶ Hold down the Command key to lock the pan angle and drag the pointer across the center of the position control.
- ▶ Press the Down or Up Arrow key to change the tilt angle until its sign changes. (You can hold down the Shift key to increase the steps.)
- ▶ Control-click the position control and choose Flip Tilt. This will reverse the sign of the tilt angle.



As with all fixture properties, changes in the Position HUD affect all selected fixtures, not just the one the HUD is attached to. You can choose how Lightkey applies fixture positions if these fixtures have different home angles, rotation directions, pan/tilt ranges and limits, or starting positions.

## Choose how angles are applied to multiple fixtures

- ▶ Click Position and choose one of the following options from the menu:
  - **Absolute:** All fixtures point in the same direction, regardless of their home angle and rotation direction (as long as the position is within their range). For example, if you select a position where the beam points upwards in the Preview, all fixtures will point upwards.
  - **Relative to Home Position:** All fixtures are assigned the same pan and tilt angles (as long as they are within their respective ranges). For example, if you select a pan angle of +30°, all fixtures move to a pan angle of +30° relative to their respective home angle.
  - **Relative to Current Position:** This mode maintains the relative distances between the fixtures. For example, if you increase the pan angle by 15° then all fixtures move by 15° from their current position.

Some fixtures allow infinite rotation around the pan or tilt axis with variable speed.

## Enable infinite pan or tilt rotation

- 1 Click  (pan) or  (tilt). Repeat to reverse the rotation direction.
- 2 Drag the Pan Speed or Tilt Speed slider to adjust the rotation speed.

## Close the Position HUD

Do one of the following:

- ▶ Click anywhere outside the HUD.
- ▶ Press Return, Enter, or Esc.

## Movement Speed

The Movement Speed property (sometimes called “Mspeed”) controls a moving light’s movement when the Position property (pan and tilt) changes. Some fixtures support multiple speed modes like Tracking or Vector. Other fixtures simply let you change the speed from slow to fast.

### Select the Movement Speed property

- 1 Select one or more fixtures which support the Movement Speed property.
- 2 Click one of the fixtures’ names and choose Movement Speed from the shortcut menu.

The keyboard shortcuts in this section require that the Movement Speed property is selected.

### Change the speed mode (if available)

- 1 Click the button below the words “Movement Speed”. (The button is only visible if your fixtures support different speed modes.)
- 2 Select one of the available options. (Lightkey only shows the options that your fixtures support).
  - **Tracking:** The fixture follows the position sent by Lightkey as closely as possible. This mode is appropriate for most situations. Always use this mode if the position is controlled by a movement path or sequence. (You can quickly select this mode by pressing T.)
  - **Tracking, Slow/Medium/Fast Speed:** Some fixtures provide specialized algorithms for slow, medium, and fast movements. See your fixture’s documentation for more information.

- **Vector:** The fixture uses an internal algorithm to calculate a smooth movement between the positions sent by Lightkey. The speed can be controlled with the Speed slider. Using this mode is usually not necessary because Lightkey can generate continuous fixture movements. (You can quickly select this mode by pressing V.)
- **Blackout During Pan/Tilt Movement:** Like tracking, but the dimmer or shutter close while the fixture is in motion. (You can quickly select this mode by pressing B.)
- **Blackout During Wheel Movement:** Like tracking, but the dimmer or shutter close during color or gobo wheel transitions.
- **Blackout During Pan/Tilt & Wheel Movements:** Like tracking, but the dimmer or shutter close while the fixture moves and during color or gobo wheel transitions.

### Change the movement speed (if available)

- 1 If the selected fixtures support multiple speed modes, make sure Vector is selected.
- 2 Do one of the following to change the vector speed:
  - ▶ Drag the Speed slider. Alternatively, place the pointer over the slider and scroll left or right. (If this doesn't work, choose Lightkey → Settings..., click Gestures, and make sure "Scrolling changes slider and HUD values" is selected.)
  - ▶ Press the Left/Right Arrow keys or Minus/Plus keys to decrease/increase the speed. (Press Option-Left/Right Arrow or Option-Minus/Plus for fine control.)

## Focus

The Focus property adjusts the beam so that the light is concentrated on the focal point.

### Open the Focus HUD

- 1 Select one or more fixtures which support the Focus property.

## 2 Do one of the following:

- ▶ Click one of the fixtures' names and choose Focus from the shortcut menu.
- ▶ Press Shift-F or press F until the Focus HUD appears.

As a shortcut, you can configure Lightkey to open the Focus HUD when you pinch on the trackpad using two fingers (requires a multi-touch trackpad or Apple Magic Trackpad). For more information, see [Multi-Touch gestures](#) in chapter 16, [External control](#).

The following tasks in this section require that the Focus HUD is open.

### Change the focus

Do one of the following:

- ▶ Click inside the focus control (the circle around the selected fixture's icon). Hold down the mouse button and drag to adjust the focus. To disable snapping press and hold the Control key.
- ▶ Place the pointer over the focus control and scroll. (If this doesn't work, choose Lightkey → Settings..., click Gestures, and make sure "Scrolling changes slider and HUD values" is selected.)
- ▶ Place the pointer over the focus control and pinch on the trackpad using two fingers (requires a multi-touch trackpad or Apple Magic Trackpad).
- ▶ Press the Up/Down Arrow keys or Plus/Minus keys to increase/decrease the focus by 10°.
- ▶ Hold down the Option key and press the Up/Down Arrow keys to increase/decrease the focus by 1°.
- ▶ Type a number to set the focus to an exact value. (Type a single digit to set the value in steps of 10°. Type two digits to set an exact value in degrees.)

### Choose how the focus is applied to multiple fixtures

- ▶ Click Focus and choose one of the following options from the menu:
  - **Absolute:** All fixtures are assigned the same focus value, regardless of their previous state.



- **Relative:** This mode maintains the relative distances between the fixtures' focus values. For example, if you increase the focus by 10%, all fixtures' focus values increase by 10% from the previous value.

### Close the Focus HUD

Do one of the following:

- ▶ Click anywhere outside the HUD.
- ▶ Press Return, Enter, or Esc.

## Zoom

The Zoom property controls the size (or spread) of the light beam by moving a lens back and forward inside the fixture.

### Open the Zoom HUD

- 1 Select one or more fixtures which support the Zoom property.
- 2 Do one of the following:
  - ▶ Click one of the fixtures' names and choose Zoom from the shortcut menu.
  - ▶ Press Shift-Z or press Z until the Zoom HUD appears.

As a shortcut, you can configure Lightkey to open the Zoom HUD when you pinch on the trackpad using two fingers (requires a multi-touch trackpad or Apple Magic Trackpad). For more information, see [Multi-Touch gestures](#) in chapter 16, [External control](#).

The following tasks in this section require that the Zoom HUD is open.

### Change the zoom angle

Do one of the following:

- ▶ Click inside the zoom control (the circle around the selected fixture's icon). Hold down the mouse button and drag to adjust the angle. To disable snapping press and hold the Control key.

- ▶ Place the pointer over the zoom control and scroll. (If this doesn't work, choose Lightkey → Settings..., click Gestures, and make sure "Scrolling changes slider and HUD values" is selected.)
- ▶ Place the pointer over the zoom control and pinch on the trackpad using two fingers (requires a multi-touch trackpad or Apple Magic Trackpad).
- ▶ Press the Up/Down Arrow keys or Plus/Minus keys to increase/decrease the zoom angle by 1°.
- ▶ Type a number to set the zoom angle to an exact value.

### Choose how zoom angles are applied to multiple fixtures

- ▶ Click Zoom and choose one of the following options from the menu:
  - **Absolute:** All fixtures are assigned the same zoom angle (as long as it is within their zoom ranges), regardless of their previous state.
  - **Relative:** This mode maintains the relative distances between the fixtures' zoom angles. For example, if you increase the angle by 20°, all fixtures' zoom angles increase by 20° from the previous value.

### Close the Zoom HUD

Do one of the following:

- ▶ Click anywhere outside the HUD.
- ▶ Press Return, Enter, or Esc.

## Iris

The Iris property controls a set of shutters which change the size of the light beam.

### Open the Iris HUD

- 1 Select one or more fixtures which support the Iris property.
- 2 Do one of the following:
  - ▶ Click one of the fixtures' names and choose Iris from the shortcut menu.
  - ▶ Press Shift-I or press I until the Iris HUD appears.

As a shortcut, you can configure Lightkey to open the Iris HUD when you pinch on the trackpad using two fingers (requires a multi-touch trackpad or Apple Magic Trackpad). For more information, see [Multi-Touch gestures](#) in chapter 16, [External control](#).

The following tasks in this section require that the Iris HUD is open.

### Change the iris size

Do one of the following:

- ▶ Click inside the iris control (the circle around the selected fixture's icon). Hold down the mouse button and drag to adjust the iris size. To disable snapping press and hold the Control key.
- ▶ Place the pointer over the iris control and scroll. (If this doesn't work, choose Lightkey → Settings..., click Gestures, and make sure "Scrolling changes slider and HUD values" is selected.)
- ▶ Place the pointer over the iris control and pinch on the trackpad using two fingers (requires a multi-touch trackpad or Apple Magic Trackpad).
- ▶ Press the Up/Down Arrow keys or Plus/Minus keys to increase/decrease the iris size by 10%.
- ▶ Hold down the Option key and press the Up/Down Arrow keys to increase/decrease the iris size by 1%.
- ▶ Type a number to set the iris size to an exact value. (Type a single digit to set the value in steps of 10%. Type two digits to set an exact percent value.)

### Choose how iris sizes are applied to multiple fixtures

- ▶ Click Iris and choose one of the following options from the menu:
  - **Absolute:** All fixtures are assigned the same iris size (as long as it is within their iris ranges), regardless of their previous state.
  - **Relative:** This mode maintains the relative distances between the fixtures' iris sizes. For example, if you increase the size by 10%, all fixtures' iris sizes increase by 10% from the previous value.

### Close the Iris HUD

Do one of the following:

- ▶ Click anywhere outside the HUD.

- ▶ Press Return, Enter, or Esc.

## Prism

The Prism property multiplies the light beam by passing it through a faceted glass lens. Each facet produces a copy of the beam at a slightly different focus. Many fixtures support rotating prisms at fixed or variable speeds. Some fixtures have multiple superimposed prisms; in this case there are multiple Prism properties which can be controlled independently.

### Select the Prism property

- 1 Select one or more fixtures which support the Prism property.
- 2 Do one of the following:
  - ▶ Click one of the fixtures' names and choose Prism from the shortcut menu.
  - ▶ Press Shift-M or press M until the Prism property is selected.



The keyboard shortcuts in this section require that the Prism property is selected.

### Select a prism type

Do one of the following:

- ▶ Click a prism icon. (Only the prism types that are supported by your fixtures are shown.)
- ▶ Type a number.

### Change the prism rotation state

- ▶ Click  or press R to enable rotation. Repeat to reverse the rotation direction, and repeat again to stop the rotation. (The symbol is only visible if the fixture supports prism rotation.)
- ▶ If the fixture supports prism rotation with variable speed: Press the mouse button over  and drag up or down to adjust the speed, or press the Minus/Plus keys. Press Option-Minus or Option-Plus for fine control.

## Rotate the prism (indexing)

- ▶ Press the mouse button over # and drag up or down to adjust the angle. Click again to disable prism indexing. (The symbol is only visible if the fixture supports prism indexing.)
- ▶ Press I to turn indexing on or off. Press the Minus/Plus keys to change the angle; press Option-Minus or Option-Plus for fine control.

## Frost

The Frost property controls a diffusion filter which softens the light beam. Some fixtures allow control over the degree of softening, others simply let you control if the effect is on or off. Some fixtures also support a frost pulse effect (gradually increasing the frost amount and abruptly reducing it, or vice versa).

### Select the Frost property

- 1 Select one or more fixtures which support the Frost property.
- 2 Do one of the following:
  - ▶ Click one of the fixtures' names and choose Frost from the shortcut menu.
  - ▶ Press Shift-R or press R until the Frost property is selected.

The keyboard shortcuts in this section require that the Frost property is selected.

### Enable or disable the frost filter

- ▶ Click On or Off or press O.

### Control the degree of softening

- 1 Click Linear or press L.
- 2 Do one of the following to adjust the frost amount:
  - ▶ Drag the Amount slider. Alternatively, place the pointer over the slider and scroll left or right. (If this doesn't work, choose Lightkey → Settings..., click Gestures, and make sure "Scrolling changes slider and HUD values" is selected.)
  - ▶ Press the Left/Right Arrow keys or Minus/Plus keys to decrease/increase the frost amount by 10%.

- ▶ Hold down the Option key and press the Left/Right Arrow keys or Minus/Plus keys to decrease/increase the frost amount by 1%.
- ▶ Type a number to set the frost amount to an exact value. (Type a single digit to set the value in steps of 10%. Type two digits to set an exact percent value.)

### Apply a frost pulse effect

- 1 Click Pulse or press P. Do this again to change the pulse direction (if the fixture supports both increasing and decreasing pulse effects).
- 2 Do one of the following to change the pulse speed:
  - ▶ Drag the Pulse Speed slider. Alternatively, place the pointer over the slider and scroll left or right. (If this doesn't work, choose Lightkey → Settings..., click Gestures, and make sure "Scrolling changes slider and HUD values" is selected.)
  - ▶ Press the Left/Right Arrow keys or Minus/Plus keys to decrease/increase the speed. (Press Option-Left/Right Arrow or Option-Minus/Plus for fine control.)

## Fog

The Fog property controls the amount of fog or haze produced by a fog machine or hazer.

### Select the Fog property

- 1 Select one or more fixtures which support the Fog property.
- 2 Do one of the following:
  - ▶ Click one of the fixtures' names and choose Fog from the shortcut menu.
  - ▶ Press Shift-0 or press 0 until the Fog property is selected.

The keyboard shortcuts in this section require that the Fog property is selected.

## Change the fog amount

Do one of the following:

- ▶ Drag the Amount slider. Alternatively, place the pointer over the slider and scroll left or right. (If this doesn't work, choose Lightkey → Settings..., click Gestures, and make sure "Scrolling changes slider and HUD values" is selected.)
- ▶ Press the Left/Right Arrow keys or Minus/Plus keys to decrease/increase the fog amount by 10%.
- ▶ Hold down the Option key and press the Left/Right Arrow keys or Minus/Plus keys to decrease/increase the fog amount by 1%.
- ▶ Type a number to set the fog amount to an exact value. (Type a single digit to set the value in steps of 10%. Type two digits to set an exact percent value.)

## Custom fixture properties

Many fixtures have additional, non-standard properties which can be controlled in the Design view. These properties can take three forms:



### Select a custom fixture property

- 1 Select one or more fixtures which support the property.
- 2 Click one of the fixtures' names and choose the property name from the shortcut menu.

The keyboard shortcuts in this section require that the property is selected.

## Slider

A slider represents a linear value in a finite range, such as 0–100% or 0–255 (the range of a DMX channel).

### Change the property's value

Do one of the following:

- ▶ Drag the slider. Alternatively, place the pointer over the slider and scroll left or right. (If this doesn't work, choose Lightkey → Settings..., click Gestures, and make sure "Scrolling changes slider and HUD values" is selected.)
- ▶ To prevent the slider from snapping to some values, hold down the Command key as you drag.
- ▶ Press the Left/Right Arrow keys or Minus/Plus keys to decrease/increase the value.
- ▶ Hold down the Option key and press the Left/Right Arrow keys or Minus/Plus keys to decrease/increase the value in smaller increments.
- ▶ Hold down the Shift key and press the Left/Right Arrow keys or Minus/Plus keys to decrease/increase the value in larger increments.
- ▶ Type a number to set the value to an exact value.

## List of options

If the property is represented by a list of options, you can choose one of the options from the list. The property may also have a slider, whose meaning usually depends on the selected option and which may not be available for all options.

### Select an option and change the slider value (if available)

- 1 Do one of the following:
  - ▶ Click the property's button.
  - ▶ Press Return or Enter (when the property is selected).

The list of options appears.

- 2 Do one of the following:
  - ▶ Click an option.
  - ▶ Type the first letters of an option's name.



- ▶ Press the Up/Down Arrow keys to select the previous/next option.

**3** If a slider is visible and enabled, do one of the following:

- ▶ Drag the slider. Alternatively, place the pointer over the slider and scroll left or right.
- ▶ Press the Left/Right Arrow keys or Minus/Plus keys to decrease/increase the value.

**4** Press Return or Enter to hide the list of options.

★ **Tip:** Double-click an option to select it and hide the options.

## Reorder or hide custom properties

By default, custom properties are ordered as they appear in the fixture profile, but you can reorder or hide properties as you like. For example, you can hide unused properties to free up space in the Design view.

You can't reorder or hide the built-in standard fixture properties.

### Reorder or hide custom properties

- 1** Select one or more fixtures with custom properties.
- 2** Click Edit in the top-right of the Design view. Alternatively, choose View → Edit Design View or press Command-Shift-Option-D.
- 3** Make changes in the Design view as appropriate:
  - ▶ To change the order of the custom properties, drag them to the desired position.
  - ▶ To hide a custom property, click the box to the left of its name.
- 4** Click Done (or press Command-Return).

### Quickly hide a fixture property

- ▶ Click the fixture property's name in the Design view and select Hide This Property from the menu.

## On/Off

The On/Off property toggles the state of a fixture. It is used by smart plugs and DMX switch packs, for example.

### Select the On/Off property

- 1 Select one or more fixtures which support the On/Off property.
- 2 Click one of the fixtures' names and choose On/Off from the shortcut menu.

The keyboard shortcuts in this section require that the On/Off property is selected.

### Turn a fixture on or off

Do one of the following:

- ▶ Click On or Off.
- ▶ Press 1 for On or 0 for Off.

## Lamp

The Lamp property turns a fixture's illuminant on or off. Lightkey automatically turns the lamp on when you start the application or open a project, and you can tell it to turn the lamp off when you quit the application or close the project. You will rarely need to use this property during normal operation. Note that only some fixtures support the Lamp property.

❖ **Note:** The Lamp property can't be stored in presets.

### Manually turn a fixture's lamp on or off

Do one of the following:

- ▶ Click the fixture's name and choose Lamp → On or Lamp → Off from the shortcut menu.
- ▶ Select the fixture and choose Fixture → Lamp → On or Fixture → Lamp → Off.

### Automatically turn the lamp off when you quit Lightkey or close the project

- 1 Choose Lightkey → Settings... (or press Command-Comma) and then click General.

- 2 Select “Send Lamp Off to fixtures” and choose how long the “lamp off” value should be sent. You can find the required duration in your fixtures’ documentation.

## Command

The Command property can be used to send various commands to a fixture. (Technically, this is done by setting a DMX channel to a certain value for a short amount of time.) The available commands depend on your fixtures; common commands are:

- Reset
- Reset Pan/Tilt
- Enable blackout during pan/tilt movement
- Disable blackout during pan/tilt movement

❖ **Note:** The Command property can’t be stored in presets.

### Send a command

Do one of the following:

- ▶ Click the fixture’s name, choose Command from the shortcut menu and then choose one of the commands from the submenu.
- ▶ Select the fixture, choose Fixture → Command and then choose one of the commands from the submenu.

## Default values

Lightkey uses sensible default values for fixture properties that aren’t defined. For example, it sets the Shutter property to “closed” and the Movement Speed to the fastest speed. You can change those defaults, if necessary, for each individual fixture.

### Change a fixture property’s default values

- 1 Select one or more fixtures in the Preview. The new defaults will only affect those fixtures.

- 2 Change the fixture property in the Design view or a HUD. The property must not be fanned or have an effect.
- 3 Press the mouse button over the fixture property name in the Design view or HUD and choose Set as Default from the menu.

If you previously set a custom default value for a fixture property you can load it—that is, add it to the overridden fixture properties—or reset it to the original state.

### **Load a fixture property's default values**

- 1 Select one or more fixtures in the Preview.
- 2 Hold down the Option key, press the mouse button over the fixture property name, and choose Load Default.

### **Reset a fixture property's default values to the original values**

- 1 Select one or more fixtures in the Preview. The change will only affect those fixtures.
- 2 Press the mouse button over the fixture property name and choose Reset Default.

## **Copy and paste fixture properties**

You can copy a fixture's properties—including fanned values and effects—to the Clipboard and then paste them to other fixtures. This copies the overridden properties or the properties of the preset being edited, but not values applied by other active presets, sequences, or cues, or default property values.

You can copy properties between fixtures of different kinds, assuming that the involved fixtures support them. Lightkey tries to convert the values as necessary: For example, if you copy a CMY fixture's Color property to an RGB fixture, Lightkey determines the matching RGB color.

### **Copy and paste fixture properties**

- 1 Do one of the following:
  - ▶ Select a single fixture, then choose Edit → Copy Properties (or press Command-C). This copies all overridden properties. To copy a single property, choose Copy Property → (property name).

- ▶ Select a single fixture, then click ☺ in the toolbar and choose Copy Properties from the menu. This copies all overridden properties. To copy a single property, choose Copy Property → (property name).
- ▶ Select one or more fixtures, then click the name of a fixture property in the Design view or a HUD and select Copy (property name) from the menu. This will copy only a single fixture property.

To copy the properties of an individual light beam, select the beam before copying.

- 2 Select one or more fixtures you want to apply the properties to. To apply the properties to individual light beams only, select those beams.
- 3 Do one of the following:
  - ▶ Choose Edit → Paste Properties (or press Command-V).
  - ▶ Click ☺ in the toolbar and choose Paste Properties from the menu.
  - ▶ Click the name of a fixture property in the Design view or a HUD and choose Paste (property name) from the menu.

❖ **Note:** The menu for copying fixture properties doesn't include properties that have been hidden from the Design view. See [Reorder or hide custom properties](#) earlier in this chapter on how to show or hide properties in the Design view.

## View overridden fixture properties

Lightkey can give you a quick overview of the fixture properties that are currently overridden.

### Show the overridden fixture properties

Do one of the following:

- ▶ Click Overrides in the toolbar.
- ▶ Click the blue dot next to a fixture's name.
- ▶ Choose Fixture → Show Properties (or press Command-P).
- ▶ Control-click in a blank part of the Preview and choose Show Properties from the shortcut menu.

Lightkey will display the names of the overridden properties next to the fixtures' icons. You can quickly select one of the properties for editing or clear a property.

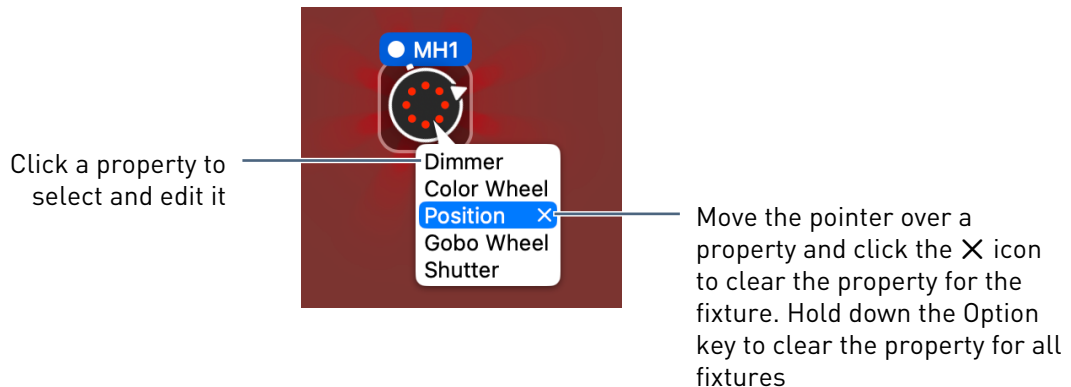

### Hide the overridden fixture properties

- ▶ Click anywhere in the Preview or press Esc, Return, or Enter.

## Clear fixture properties

You can quickly clear (or “undefine”) some or all overridden properties. This will also remove effects and fanning.

### Clear a single fixture property

- 1 Select one or more fixtures.
- 2 Do one of the following:
  - ▶ Click the blue (or gray) dot to the left of the property’s name in the Design view or the property’s HUD.
  - ▶ Select a fixture property and press the Space bar or Delete key.

### Clear all overridden fixture properties for a set of fixtures

- 1 Select one or more fixtures.
- 2 Do one of the following:
  - ▶ Click one of the fixtures’ names and choose Clear Properties from the shortcut menu.
  - ▶ Click ☺ in the toolbar and choose Clear Properties from the menu.
  - ▶ Select Fixture → Clear Properties (or press Delete).

## Clear all overridden properties from all fixtures

Do one of the following:

- ▶ Click  in the toolbar.
- ▶ Select Fixture → Clear Properties for All Fixtures (or press Command-Shift-Delete).
- ▶ Control-click a blank part of the Preview and choose Clear Properties for All Fixtures from the shortcut menu.

After all properties have been cleared, the blue dots to the left of the fixtures' names in the Preview disappear.

## Undo changes

If you inadvertently changed a fixture property, you can undo the change. You can also redo changes that you have undone.

### Undo or redo changes

- ▶ To undo the last action, choose Edit → Undo (or press Command-Z).
- ▶ To redo the last action you undid, choose Edit → Redo (or press Command-Shift-Z).

## Fanning

**Fanning** (also called “spreading”) lets you create interesting looks by distributing fixture property values evenly across a range of fixtures. You define the property values for at least two fixtures or beams—usually the first and last—, and Lightkey calculates the values for the fixtures or beams in between. In the following, the term **pixel** is used for the smallest unit which can be individually controlled—either a fixture or a beam. Depending on the fixture property being fanned, the term **value** refers to a percentage, color, fixture position, etc.

**Example:** By fanning colors across the beams of LED strips you can easily create color gradients.



**Example:** Pan angles spread over a row of moving lights.



You can apply fanning to the following fixture properties:

- Dimmer
- Color
- Position
- Focus
- Zoom
- Iris
- Frost
- Fog
- Any custom property represented by a slider

Like regular property values, fanned properties can be stored in presets, sequences, and cues while staying fully editable at any time.

## Fan a fixture property

You can apply fanning to any fixture property listed above.

### Fan a fixture property

- 1 Select at least three fixtures, or an LED fixture with at least three beams.
- 2 Do one of the following to select a fixture property:
  - ▶ Click one of the fixture's names and select a property from the shortcut menu.
  - ▶ Choose Fixture → Select Property, then select a property from the menu.
- 3 Click the fixture property's name in the Design view or the property's HUD, then choose Add (property name) Fanning... from the menu.

Lightkey displays the Fanning HUD around the fixtures' icons in the Preview.



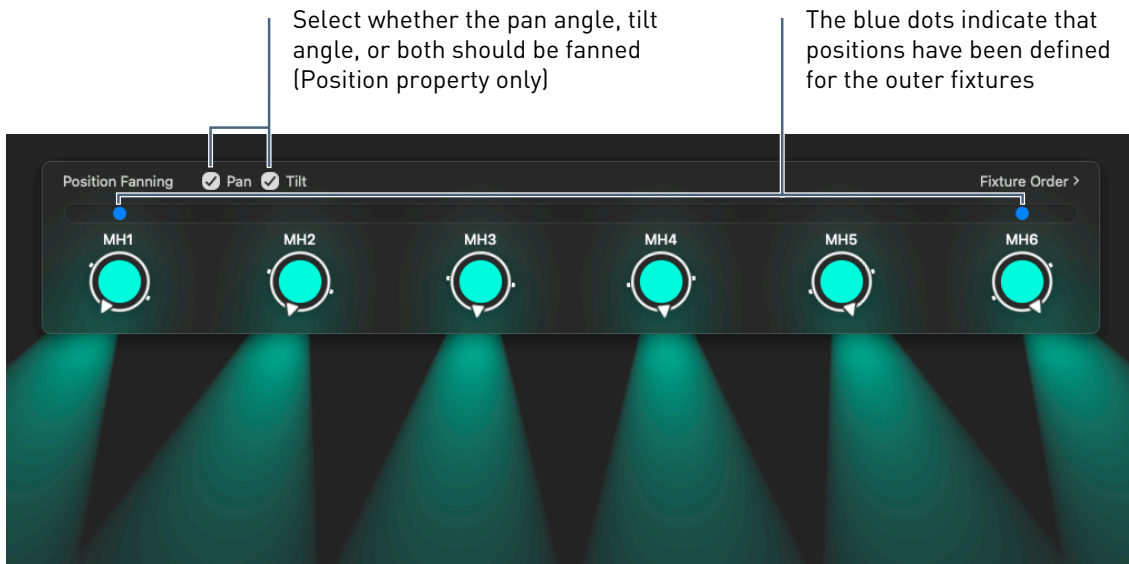

In the example above, the fixtures are ordered from left to right. There are other possibilities for ordering fixtures and beams which affect the result of the fanning.

### Change the order of fixtures (or beams)

- 1 When the Fanning HUD is visible, click Fixture Order.

As you move the mouse pointer over an item in the menu, Lightkey shows the resulting fixture order in the Preview.

- 2 Select an option as appropriate:

- **Left to Right:** Sort the fixtures or beams from left to right as they appear in the Preview.
- **Right to Left:** Sort the fixtures or beams from right to left as they appear in the Preview.
- **Top to Bottom:** Sort the fixtures or beams from top to bottom as they appear in the Preview.
- **Bottom to Top:** Sort the fixtures or beams from bottom to top as they appear in the Preview.
- **By Short Name:** Sort the fixtures alphabetically by their short name, either ascending or descending. Beams are sorted by their index.
- **By Address:** Sort the fixtures by their universe and DMX address, either ascending or descending. Beams are sorted by their index.
- **Consider Spacing:** When using one of the position-based options, consider the distances of the pixels in the Preview.

- **Select Fixtures:** Treat all beams of a fixture as a single pixel.
- **Select Beams:** For fixtures with multiple beams, treat the beams as individual pixels.

**Example:** Colors fanned across multiple fixtures with the Left to Right order.

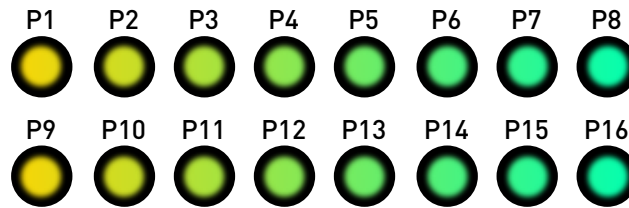

If the By Short Name order is selected instead, the result would look like this:

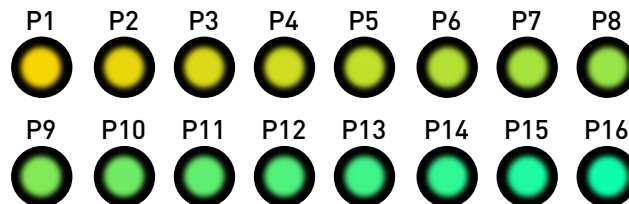

**Example:** Colors fanned from left to right across four LED matrixes using the Fixtures option. All beams of each matrix have the same color.

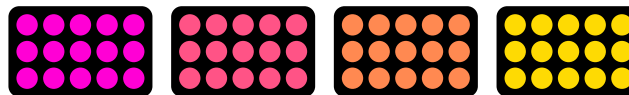

If the Beams option is selected instead, fanning includes the individual beams:

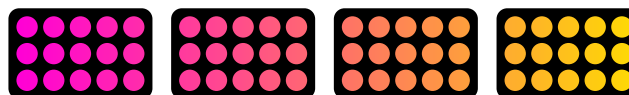

**Example:** Positions fanned across six unevenly spaced moving lights.

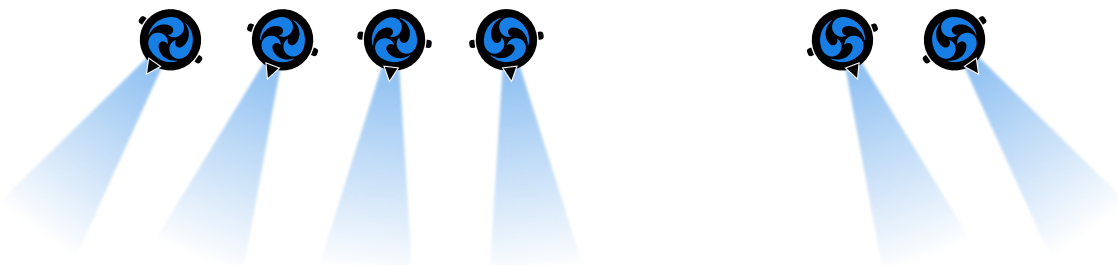

The same example with the Consider Spacing option selected:

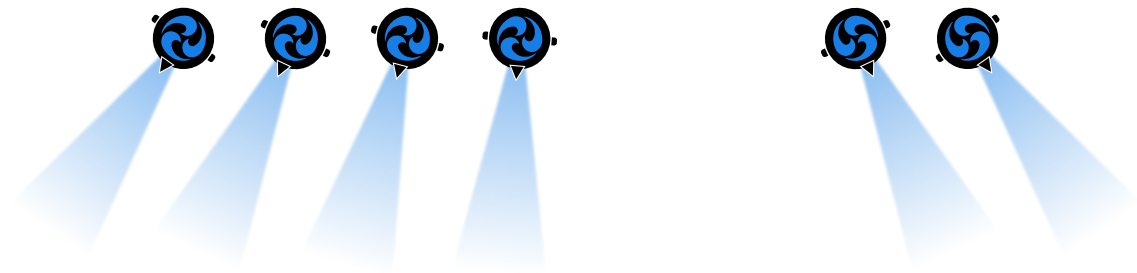

### Define the value for a fixture or beam

- ▶ Click the fixture or beam, then choose a value.

A blue dot near the fixture or beam indicates that a value has been defined. The values for the fixtures or beams in between are calculated automatically.

### Change the value for a fixture or beam

- 1 Do one of the following:
  - ▶ Click the fixture or beam with a value.
  - ▶ Press Tab to edit the first fixture or beam with a value, or Shift-Tab to edit the last.
- 2 Change the value as desired.
- 3 Press Tab or Shift-Tab to edit the previous or next value.
- 4 Press Return, Enter, or Esc to end editing.

### Remove the defined value for a fixture or beam

Do one of the following:

- ▶ Click the blue dot near the fixture or beam.
- ▶ Control-click the fixture or beam and choose Delete from the shortcut menu.

You can't remove the last two defined values.

### Copy a value to another pixel or beam

- 1 In the Fanning HUD, Control-click a fixture or beam with a value, then choose Cut or Copy from the shortcut menu.



- 2 Control-click another fixture or beam and then choose Paste.

## Edit Fanning

When a fixture property is being fanned, its area in the Design view shows an icon instead of the normal controls. You can open the Fanning HUD and edit the fanning settings at any time.

### Edit a fanned fixture property

Do one of the following:

- ▶ Click the icon in the Design view.
- ▶ Click a fixture's name in the Preview, then select a fixture property from the shortcut menu. Fanned properties are marked with an  icon.
- ▶ Click Overrides in the toolbar. The names of the overridden properties appear next to the fixtures' icons, and an  icon marks fanned properties. Click a fixture property's name to edit it.

## Delete Fanning

When you delete fanning, you can either keep the fanned values or clear the entire fixture property so it's no longer defined.

### Delete fanning and keep the fanned values

- ▶ While the Fanning HUD is open, click the title at the upper-left and choose Delete Fanning and Keep Values from the menu.

### Delete fanning

Do one of the following:

- ▶ While the Fanning HUD is open, click the title at the upper-left and choose Delete Fanning from the menu.
- ▶ If the fixture property appears in the Design view, select the fixtures and then click the blue dot to the left of the property's name in the Design view.
- ▶ Click  in the toolbar or choose Fixture → Clear Properties for All Fixtures (or press Command-Shift-Delete). This will also remove any other overridden properties from all fixtures.

# Chapter 9

## Presets and sequences

---



Presets and sequences are the basic building blocks of your light show. They are also the basis for cues, which will be introduced in the next chapter.

A **preset** stores an arbitrary combination of fixture properties for a set of fixtures. For example, it could include colors and intensities for a number of moving heads, or their pan/tilt positions. A preset can contain different properties for different fixtures. Presets can also contain effects, which are treated like a special value for a fixture property and remain editable at any time.



Although the concept of presets is deliberately flexible, there are common patterns for using them. You may want to create “looks” for groups of related fixtures which you can later combine to a complete scene. A more modular approach is to create presets with only one or two properties for a given group of fixtures. There could be a set of “color” presets, another set of “gobo” presets, and so on, which you can later use to quickly compose a look on the stage.

Whichever way you prefer, it is a good idea to organize similar presets in **groups**. Here’s an example of three typical preset groups:

∨ Moving Head Colors

-  Deep Blue
-  Lime Green
-  Color Change

∨ Moving Head Gobos

-  Spiral
-  Spiral (rotating)
-  Flower (shaking)

∨ LED Bars

-  Magenta
-  Orange
-  Yellow

Presets remain editable at any time. When you change a preset, the change affects all cues which use it. That makes presets a great way to build a flexible system which lets you adjust parameters like positions or intensities throughout the project.

A **sequence** contains a number of presets (called **steps**) which are activated one after the other. Each step has a duration which determines how long it remains active. Lightkey can crossfade between two succeeding steps, which can be the basis for interesting effects. There are various settings which control the order and timing of sequences. You can also synchronize sequences to music, which means they will advance to the next step in sync to the beat.

Presets and sequences appear in the Preset Palette at the right side of the main window.

### If you don't see the Preset Palette

- ▶ Choose View → Show Preset Palette.

## Create a preset

There are two ways to create a preset: You can define some fixture properties and then save the result as a preset. Or you can begin with an empty preset and then define its fixture properties.

You can also capture the current state of all fixtures in a new preset.



### Create a preset from the overridden fixture properties

- 1 Select one or more fixtures and change their properties. (See chapter 8, [Fixture properties](#), for more information.) Fixtures with overridden properties display a blue dot to the left of their name in the Preview.
- 2 Do one of the following:
  - ▶ Click + in the toolbar.
  - ▶ Choose Preset → New Preset (or press Command-N).
  - ▶ Control-click an item in the Preset Palette and choose New Preset from the shortcut menu. (If the clicked item is a group or sequence, the new preset is added at the end of the group or sequence. If the clicked item is a preset, the new preset is inserted after the preset.)

A new preset appears in the Preset Palette, containing the overridden properties of all fixtures. Lightkey automatically creates an icon and proposes a name for the preset depending on its content.

- 3 If you want to keep the proposed name, simply press Return. Otherwise type a different name and then press Return.

### Create a preset that is initially empty

- 1 Click  in the toolbar or choose Fixture → Clear Properties for All Fixtures to make sure no fixture properties are overridden.
- 2 Click  in the toolbar, or use one of the alternatives listed above.  
A new, empty preset appears in the Preset Palette.
- 3 Select one or more fixtures and change their properties.
- 4 Click the checkmark next to the preset's name in the Preset Palette.

### Create a preset which captures the current state of all fixtures

- 1 Do one of the following:
  - ▶ Press the mouse button over the  symbol in the toolbar until a menu appears, then choose New Preset With Snapshot.
  - ▶ Choose Preset → New Preset With Snapshot.
  - ▶ Control-click an item in the Preset Palette and choose New Preset With Snapshot from the shortcut menu.

A new preset appears in the Preset Palette, containing the state of all fixtures at the time the preset was created. The preset includes all fixtures and all properties, even if a fixture is off.

- 2 Enter a name for the preset and then press Return.

## View preset contents

Lightkey can give you a quick overview of the fixtures and fixture properties affected by a given preset.

## Show the contents of a preset

Do one of the following:

- ▶ Click the preset in the Preset Palette. (This will also activate the preset, as described below.)
- ▶ Control-click the preset and choose Show Properties from the shortcut menu.

Lightkey will display the names of the properties defined for each fixture next to the fixture icons in the Preview.

## Hide the contents of a preset

Do one of the following:

- ▶ Click anywhere in the Preview.
- ▶ Press Esc, Return, or Enter.

## Activate or deactivate presets

A preset is active when it's selected in the Preset Palette. When a preset is active, its fixture properties are applied to the fixtures. (Note that overridden fixture properties take precedence over active presets.)

### Activate a preset

- ▶ Click the preset in the Preset Palette.

### Activate a range of presets

- 1 Click the first preset.
- 2 Hold down the Shift key and click the last preset.

### Toggle a preset's active state

- ▶ Hold down the Command key and click the preset.

### Deactivate all presets

- ▶ When the Preset Palette has focus, choose Edit → Deactivate All (or press Command-Shift-A or Esc).



Active presets take precedence over cues (see chapter 11, [Live Control](#)). It's therefore a good idea to deactivate all presets before you run a show from the Live view.

## Edit a preset

You can always change the fixture properties stored in a preset after it has been created.

### Edit the fixture properties in a preset

- 1 Do one of the following:
  - ▶ Move the pointer over the preset in the Preset Palette and click Edit.
  - ▶ Hold down the Command key and double-click the preset.
  - ▶ Click the preset in the Preset Palette and choose Preset → Edit (or press Command-Shift-E).
  - ▶ Control-click the preset and choose Edit from the shortcut menu.

While you are editing a preset, its name appears in the center area of the toolbar.

- 2 Make changes to the fixture properties. (See chapter 8, [Fixture properties](#), for more information.)
- 3 Click Update next to the preset's name in the Preset Palette, or press Return. (To discard your changes and return to the preset's previous state, hold down the Option key and click Cancel next to the preset's name, choose Preset → Cancel Editing, or press Esc).

Lightkey will update the preset's contents and icon. If the preset's name has been automatically assigned by Lightkey, it is updated too.

## Presets and overridden properties

You can add the contents of a preset—that is, the fixture properties it defines—to the overridden fixture properties. When you do this, the fixture properties in the preset replace any previous values for those properties. Fixture properties not defined by the preset remain unchanged.

## Add the contents of presets to the overridden properties

Do one of the following:

- ▶ Select one or more presets in the Preset Palette and choose Preset → Apply.
- ▶ Control-click a preset and choose Apply from the shortcut menu.
- ▶ Select one or more presets and drag them to the Preview area.

Hold down the Option key to only change the selected fixtures.

You can use the same technique to merge two presets.

## Merge two presets

- 1 Move the pointer over the first preset in the Preset Palette and click Edit.
- 2 Control-click the second preset and choose Apply from the shortcut menu.
- 3 Click the checkmark next to the first preset's name in the Preset Palette, or press Return.

If some fixture properties are defined by both presets, the properties from the second preset will replace those from the first preset.

In reverse, you can also add the overridden fixture properties to one or more existing presets. In this case the overridden properties replace any previous values in the presets. Fixture properties that aren't overridden remain unchanged.

This technique is an alternative to editing the preset, as described earlier. It is especially useful when you need to change multiple presets at once.

## Add the overridden fixture properties to one or more presets

- 1 Select one or more fixtures and change their properties. (See chapter 8, [Fixture properties](#), for more information.) Fixtures with overridden properties display a blue dot to the left of their name in the Preview.
- 2 Do one of the following:
  - ▶ Select one or more presets in the Preset Palette and choose Preset → Add Overrides.
  - ▶ Control-click a preset and choose Add Overrides from the shortcut menu.

- ▶ To add the overridden properties for the selected fixtures only, hold down the Option key as you perform one of the preceding steps. The command changes to Add Overrides for Selected Fixtures.

## Create a preset group

As your list of presets grows, you may find it easier to create groups of similar presets, which can be collapsed and expanded as necessary. Apart from presets, groups can also contain sequences and other groups.

### Create an empty preset group

- 1 Do one of the following:
  - ▶ Press the mouse button over the + symbol in the toolbar until a menu appears, then choose New Group.
  - ▶ Choose Preset → New Group (or press Command-Shift-N).
  - ▶ Control-click an item in the Preset Palette and choose New Group from the shortcut menu.
- 2 Enter a name for the group and then press Return.

### Create a group from existing items

- 1 Select some presets, sequences, or groups in the Preset Palette. (Hold down the Shift or Command key to select multiple items.)
- 2 Do one of the following:
  - ▶ Press the mouse button over the + symbol in the toolbar until a menu appears, then choose New Group From Selection.
  - ▶ Choose Preset → New Group From Selection (or press Command-Option-Shift-N).
- 3 Enter a name for the group and then press Return.

### Expand or collapse a group

Do one of the following:

- ▶ Click the disclosure triangle to the left of the group name.
- ▶ Click the group in the Preset Palette and choose Preset → Expand/Collapse Group (or press Command-Left/Right Arrow).

## Create a sequence

Sequences look similar to groups in the Preset Palette; you can distinguish them by their icon to the left of the name. Like groups, they can be collapsed and expanded. Sequences contain a list of presets, but unlike groups, they cannot contain groups or other sequences. The presets in a sequence are also called **steps**.

### Create an empty sequence

- 1 Do one of the following:
  - ▶ Press the mouse button over the **+** symbol in the toolbar until a menu appears, then choose New Sequence.
  - ▶ Choose Preset → New Sequence (or press Command-Control-N).
  - ▶ Control-click an item in the Preset Palette and choose New Sequence from the shortcut menu.
- 2 Type a name for the sequence and then press Return.

### Create a sequence from existing presets

- 1 Select the presets in the Preset Palette. (Hold down the Shift or Command key to select multiple presets.)
- 2 Do one of the following:
  - ▶ Press the mouse button over the **+** symbol in the toolbar until a menu appears, then choose New Sequence From Selection.
  - ▶ Choose Preset → New Sequence From Selection (or press Command-Control-Option-N).
- 3 Type a name for the sequence and then press Return.

## View sequence contents

Lightkey can give you a quick overview of the fixtures and fixture properties affected by a given sequence—or, more precisely, all fixture properties affected by any preset in the sequence.

### Show the contents of a sequence

Do one of the following:

- ▶ Click the sequence in the Preset Palette.

- ▶ Control-click the sequence and choose Show Properties from the shortcut menu.

Lightkey will display the names of the properties defined for each fixture next to the fixture icons in the Preview.

### Hide the contents of a sequence

Do one of the following:

- ▶ Click anywhere in the Preview.
- ▶ Press Esc, Return, or Enter.

## Run sequences

### Run or stop a sequence

Do one of the following:

- ▶ Click ▶ or ◻ to the right of the sequence's name in the Preset Palette.
- ▶ Click the sequence in the Preset Palette and choose Preset → Start Sequence or Preset → Stop Sequence.

## Sequence order

There are various options which determine the order in which the steps in a sequence are activated. As an example, consider a sequence with four steps which define different fixture colors:

	Name
●	Green
●	Orange
●	Red
●	Purple

If you run the sequence with the default settings, each step is activated once, from top to bottom:



## Change a sequence's order

### 1 Do one of the following:

- ▶ Double-click the sequence in the Preset Palette.
- ▶ Control-click the sequence and choose Get Info from the shortcut menu.

### 2 In the window that appears, click Options at the top and change the settings as appropriate:

- ▶ **Repeat:** Choose how many times the sequence repeats before it stops. Click the arrow in the text field and choose "inf" from the menu to make the sequence repeat infinitely.



- ▶ **Backwards:** If selected, the steps will be activated in reverse order (from bottom to top).



- ▶ **Autoreverse:** If selected, the sequence will reverse its direction after each pass. (The repeat count must be greater than one for this to have an effect.) If the Backwards option is selected, the first pass will be backwards; otherwise the first pass will be forwards.



- ▶ **Random:** With this option, each pass through the sequence activates the steps in a random order. The Backwards and Autoreverse options are ignored.
- ▶ **Freeze on completion:** If selected, the last step will remain active when the sequence has finished.

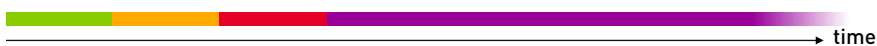

❖ **Note:** The options for Pan/Tilt movements in this window are described below in [Create fixture movements with sequences](#).

## Reorder sequence steps

Lightkey provides two useful commands to quickly reverse the order of steps in a sequence or to reorder them randomly (shuffle).

## Reverse of shuffle all steps in a sequence

Do one of the following:

- ▶ Select the sequence in the Preset Palette, then choose Preset → Reverse Presets or Presets → Shuffle Presets.
- ▶ Control-click the sequence and choose Reverse Presets or Shuffle Presets from the shortcut menu.

## Reverse or shuffle some of the steps in a sequence

- 1 Select some steps in the same sequence. (Hold down the Shift or Command key to select multiple items.)
- 2 Do one of the following:
  - ▶ Choose Preset → Reverse Presets or Presets → Shuffle Presets.
  - ▶ Control-click one of the selected steps and choose Reverse Presets or Shuffle Presets from the shortcut menu.

## Sequence timing

A sequence can either use manual timing or beat-controlled timing. This section discusses the various parameters in the two modes and how they affect timing.

### Manual timing

When using manual timing, each step in a sequence has a **hold time** which determines how long the step remains active. Consider the example from the previous section with the following hold times:

	Name	Hold Time
●	Green	00:02.0
●	Orange	00:04.0
●	Red	00:02.0
●	Purple	00:04.0

If you run the sequence, it would look like this:

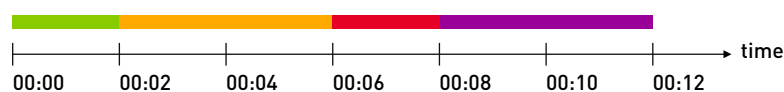

Lightkey can crossfade between consecutive steps. During the crossfade, fixture property values gradually change from the old to the new state. Crossfading only works under the following conditions:

- The fixture property must be fadeable. For example, Lightkey can fade between Dimmer or Focus values but not between Shutter states like open and closed. Properties which are not fadeable will change in the middle of the crossfade period.
- The fixture property must be defined in both the old and new step. For example, to have a fixture gradually light up from no to full intensity, the first step must define the Dimmer property with a value of 0% and the second step must define it with a value of 100%.

The duration of a crossfade is called the **fade time**; it is added to the hold time. By default the fade time is zero, so all properties change instantly, as in the previous example. Here's the same sequence with a fade time of 1 second:

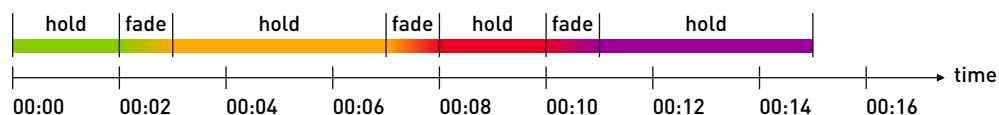

➤ **Important:** Fade times do not apply to smart lights. They use a fixed fade time which can't be changed in Lightkey.

By setting the hold times to zero you can create a continuous animation. Changing the hold times to zero and the fade times to 4 seconds creates a rainbow effect:

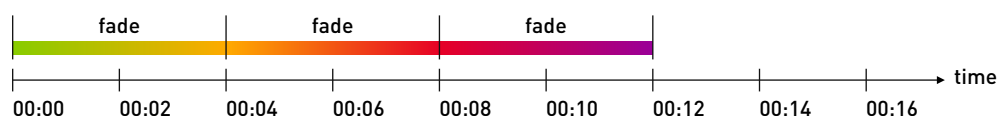

The crossfade between steps is also affected by the **fade curve** which appears to the left of the fade time. For details see [Fade curves](#) in chapter 11, [Live control](#).

A sequence has a **default hold time, fade time, and fade curve**. They are initially applied to all steps in the sequence but can be overridden for individual steps, as described below.



❖ **Note:** The fade time for the last step is only meaningful if the sequence repeats. In this case it defines the time to fade from the last step to the first.

When using manual timing, you can quickly change the overall speed of a sequence through its **speed rate**. All hold and fade times are multiplied by this factor. Its default value is 1.

Here's the original sequence with a speed rate of 0.5:

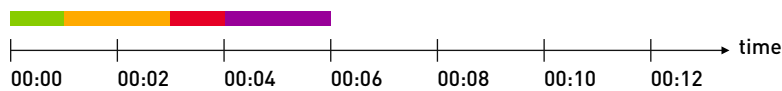

Here's the original sequence with a speed rate of 1.5.

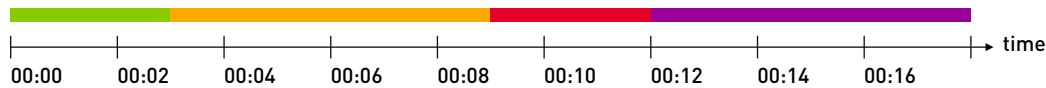

## Beat-controlled timing

Beat-controlled timing lets you synchronize a sequence to music. In the simplest case the sequence advances to the next step on each beat:



You can extend individual steps by increasing their **length**. If you set the length of the second and fourth step to 2, the sequence looks like this:



To scale the entire sequence you can use a **beat multiplier**. In the previous examples the beat multiplier was 1. Setting the beat multiplier to  $\div 2$ , for example, results in the following timing:

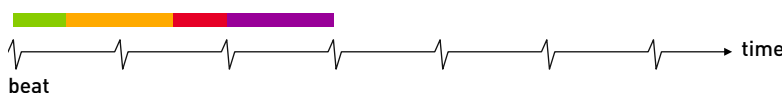

The beat multiplier does not only make the sequence shorter or longer, but scales the beat grid to which the sequence steps are aligned. All beat-controlled sequences and effects with the same multiplier use the same beat grid, so they all advance together even if they were started at different times. For example, all sequences and effects with a multiplier of  $\times 4$  will advance on beats 0, 4, 8, and so on.

In the preceding examples, the start of the sequence fell exactly on a beat. This is no coincidence—Lightkey uses a technique called **quantization** by default to align the sequence start with the beat. With quantization enabled, Lightkey waits for the next beat before activating the first step. If a sequence is started very shortly after a beat, it may also activate the first step immediately.



To further align the sequence on the beat grid you can increase its **quantum**. The sequence in the example is four beats long, so you may want to align it to a full bar when using a quadruple meter. Setting the quantum to 4 constrains the possible start points for the sequence to every 4th beat—that is, beats 0, 4, 8, and so on. As a consequence Lightkey may skip several beats before the first step becomes active:

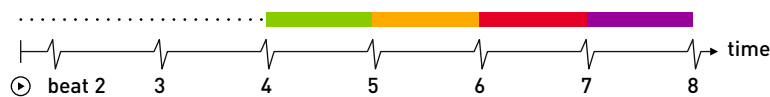

Sequences with a beat multiplier are already aligned to a scaled beat grid. If you also apply a quantum, it is multiplied with the beat multiplier: For example, a sequence with a multiplier of  $\times 4$  and a quantum of 2 can start on every 8th beat.

When you sync Lightkey's beat grid to an audio software, sometimes beat numbers are shifted by one or more beats. You can apply an **offset** to correct this. For example, a sequence with a quantum of 4 and an offset of 1 may start at beats 1, 5, 9, and so on.

If you want a sequence to start immediately without any wait time you can disable quantization. This is useful to avoid blackouts between cues, for example. If you start the sequence between two beats then the first step will be shorter than the following ones:



Beat-controlled sequences don't have hold times, but you can still set fade times. Unlike with manual timing they do not prolong the total duration of the sequence. If the interval between two beats is shorter than the fade time, the fade will be interrupted.

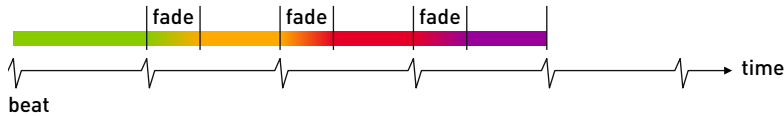

For information on how to set the tempo and sync it to external sources see chapter 12, [Beat control](#).

### Change a sequence's timing options

- 1 Do one of the following:
  - ▶ Double-click the sequence in the Preset Palette.
  - ▶ Control-click the sequence and choose Get Info from the shortcut menu.
- 2 In the window that appears, click Timing at the top and change the settings as appropriate. Select "Individual fade times" to allow individual steps to override the default fade time, as described below.

### Change the hold or fade time of individual steps

- 1 Select one or more steps. (Hold down the Command or Shift key as you click to select multiple steps.) By selecting multiple steps you can change their hold or fade times at once.
- 2 Click the hold or fade time (to the right of the step name). The fade time is only visible if the Individual option is selected in the sequence inspector.
- 3 Enter a new value. You can press the Up/Down Arrow keys to increase/decrease the time by one second. Leave the field empty to use the sequence's default hold or fade time.
- 4 Press Return to end editing.

★ **Tip:** When editing hold or fade times, press Tab or Shift-Tab to quickly jump to the next or previous field.

You can change the initial hold and fade times for new sequences in the Timing pane of Lightkey's Settings window. You can also increase the precision (number of decimal places shown) for hold and fade times.

### Change the hold and fade times for newly created sequences

- 1 Choose Lightkey → Settings... (or press Command-Comma) and click Timing.
- 2 Change the values in the fields for the sequence hold and fade time. (To revert a value to the standard value, delete the field contents and press Return.)

### Change the precision for hold and fade times

- 1 Choose Lightkey → Settings... (or press Command-Comma) and click Timing.
- 2 Select an option from the "Time precision" pop-up menu.

## Create fixture movements with sequences

If the steps in a sequence define different pan/tilt positions, your fixtures will move between these positions as the sequence runs. Lightkey provides different options to control the exact movement of the fixtures.

❖ **Note:** Another way to create fixture movements are movement effects, as described in chapter 10, [Effects](#). Each technique has its advantages and drawbacks. A movement effect is quick to create, easy to reuse on different fixtures, and provides a better visual impression of how the fixture moves. On the other hand, a sequence lets you combine the fixture movement with other property changes and gives you more control over timing.

As an example, consider a sequence with five steps which define positions for a fixture:

Name	Hold Time	Fade Time
Position 1 (P1)	00:01.0	00:02.0
Position 2 (P1)	00:01.0	00:06.0
Position 3 (P1)	00:01.0	00:04.0
Position 4 (P1)	00:01.0	00:02.0
Position 5 (P1)	00:01.0	00:02.0

The following graph shows when the fixture reaches the different positions if no special options are applied. In the graph, the vertical dimension represents the fixture position (which actually consists of two dimensions, pan and tilt). During the crossfade periods, Lightkey linearly interpolates the fixture positions between the previous and next step.

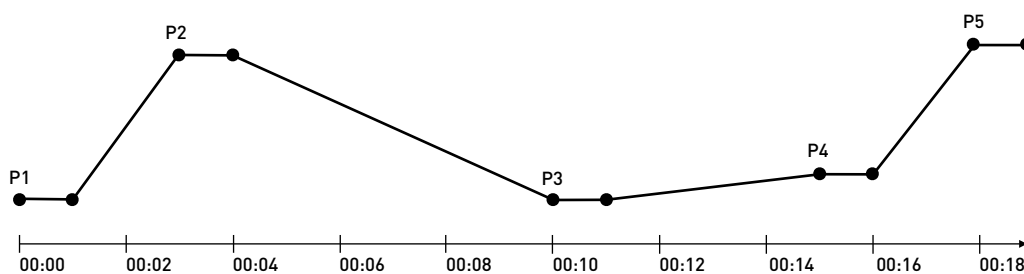

Changing all hold times to zero creates a continuous movement where the fixture moves like this:

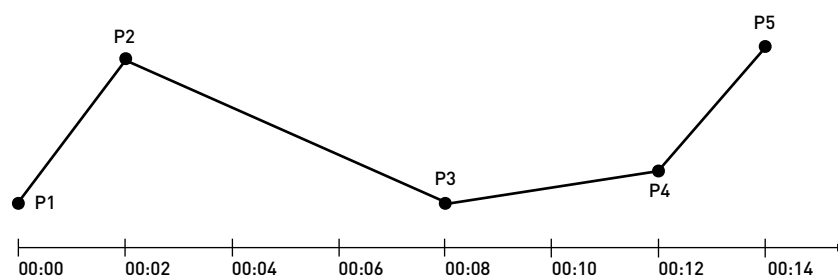

The fixture moves on the direct way from one position to the next, changing its movement direction at each point. If you want a smoother movement instead, you can select the option "Smooth movements".

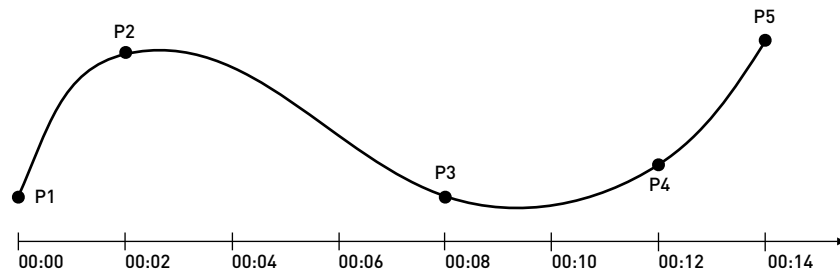

Lightkey will calculate a curve which passes all five fixture positions at the times determined by the steps' hold and fade times. For example, the time it takes to move from P1 to P2 is the sum of the first step's hold and fade times (with this option there is no longer a difference between hold and fade time).

The movement speed from each position to the next may vary—it depends on the hold/fade times and the distance between the positions. In the example, P1 and P2 are relatively far apart, but the fade time is short, so the fixture moves at a high speed. To create a uniform movement, select the option "Constant pace".

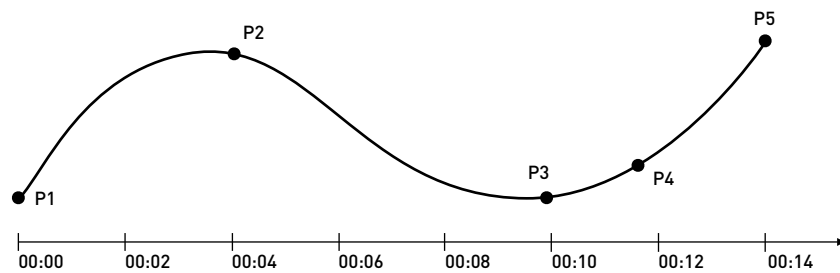

Lightkey will adjust the time at which each position is reached so that the fixture moves at (approximately) constant speed (ignoring the individual hold/fade times). The total time for moving through the sequence is still the same (that is, it is determined by the total hold and fade times).

## Organize presets and sequences

Here are ways to organize presets, groups, and sequences in the Preset Palette.

### Move a preset, group, or sequence

- ▶ Drag the item up or down in the Preset Palette. You can move items in and out of groups and sequences (however, sequences can't contain groups or other sequences).

## Reorder multiple presets, groups, or sequences

- 1 Select the items in the Preset Palette. Hold down the Shift or Command key to select multiple items.
- 2 Drag the selected items to the desired position.

## Rename a preset, preset group, or sequence

- 1 Click the preset, preset group, or sequence in the Preset Palette to select it.
- 2 Do one of the following:
  - ▶ Click the item's name in the Preset Palette.
  - ▶ Choose Edit → Rename (or press Return).
  - ▶ Control-click the item and choose Rename from the shortcut menu.
- 3 Enter a new name and then press Return.

## Duplicate a preset, preset group, or sequence

- 1 Click the preset, preset group, or sequence in the Preset Palette to select it.
- 2 Choose Edit → Duplicate (or press Command-Shift-D). Lightkey will create a copy of the item below the original item.

After duplicating a preset, Lightkey will automatically begin to edit it (see [Edit a preset](#)).

## Duplicate a preset, preset group, or sequence by dragging

- ▶ Hold down the Option key and drag the preset, preset group, or sequence. Lightkey will add a copy of the item at the target location.

After duplicating a preset, Lightkey will automatically begin to edit it (see [Edit a preset](#)).

## Delete a preset, preset group, or sequence

- 1 Click the item in the Preset Palette to select it. (Hold down the Shift or Command key to select multiple items.)
- 2 Do one of the following:
  - ▶ Choose Edit → Delete.
  - ▶ Control-click the item and choose Delete from the shortcut menu.

- ▶ Press Delete.

- 3 If the preset or sequence is part of a cue, an alert message will appear. Click Delete to delete the item and remove it from any cues.

If you accidentally deleted an item, choose Edit → Undo Delete.

## Filter items in the Preset Palette

To quickly find an item you can filter the Preset Palette so only items whose name contains the search text are shown.

### Filter items in the Preset Palette

- 1 Do one of the following:
  - ▶ Click **Q** in the toolbar.
  - ▶ Choose Edit → Find... (or press Command-Option-F).

A search field appears near the right end of the toolbar.

- 2 Click the **Q** symbol in the search field and choose Preset Palette from the menu.
- 3 Enter the text to search for in the search field. As you type the Preset Palette is filtered accordingly.
- 4 To remove the filter click **✕** in the search field.

## Export and import items in the Preset Palette

You can export the items in the Preset Palette—presets, sequences, and groups—to a file which you can then import into other projects. If the projects have different sets of fixtures, you can choose how the fixtures are mapped during import.

### Export items from the preset palette

- 1 Choose Preset → Export...
- 2 In the dialog that appears, enter a filename and choose a location.
- 3 Select either “All items” (export all items in the Preset Palette) or “Selected items” (export only the currently select items).



- 4 Click Export.

### **Import items into the preset palette**

- 1 Choose Preset → Import...
- 2 In the dialog that appears, select a file that was previously exported, then click Continue.
- 3 The next dialog lets you choose how fixtures in the source project should be mapped to those in the current project. The left column shows the fixtures in the current project. On the right, select the corresponding fixture in the source project.

You can select multiple rows to assign a source fixture to all of them.

- 4 Click Import.

The imported items are added at the end of the Preset Palette.

# Chapter 10

## Effects

---

Lightkey's powerful effects engine makes it easy and fun to create dynamic looks. It comes with over 70 editable templates and lets you build custom effects for almost any fixture property. Synchronize effects to music and overlay multiple effects for limitless possibilities.

An **effect** controls the value of a fixture property for an arbitrary set of fixtures. Often the fixtures are of the same type, but they don't have to be. Effects can be applied to the individual beams of an LED fixture or across multiple fixtures. They are always applied to entire fixtures. Like regular property values, effects can be stored in presets, sequences, and cues while staying fully editable at any time.

There are three basic kinds of effects which apply to different fixture properties:

Effect	Use for
Pattern	Dimmer, Color
Curve	Dimmer, Color, Position, Focus, Zoom, Iris, Frost, Fog, any custom property represented by a slider
Movement	Position

## Pattern effects

A **pattern effect** generates a pattern from a set of predefined samples. Pattern effects can be applied to the Dimmer and Color properties, so the term **sample** refers to either an intensity value (0–100%) or a color. You can choose from a number of patterns such as a chase. Some patterns repeat after a predefined duration, others change randomly.

## Curve effects

A **curve effect** lets you draw a curve which determines the fixture property's value at a given time. Lightkey comes with a number of built-in curves—for example, a sine wave—but also lets you draw completely new curves.

Some fixture properties consist of multiple components, each of which has its own curve:

- **Color:** A color usually consists of at three components which depend on the color model. Color models are HSB (hue, saturation, brightness), RGB (red, green, blue), CMY (cyan, magenta, yellow). In addition, the following components may be added if the fixtures support them: cool white, warm white, amber, lime, ultraviolet.
- **Position:** A moving light's position consists of the pan angle and tilt angle.

## Movement effects

A **movement effect** describes a continuous pan and tilt movement along a predefined closed path—for example, a circle or a figure eight. Movement paths are defined by two or more control points from which Lightkey interpolates the fixture's position at any given time.

Lightkey allows you to design movement paths in a natural way: The points on the path give an indication of where the light beam points in reality, and the path's shape (although only in 2D) resembles the actual movement. This may be different from other applications which show movement paths in a Cartesian coordinate system which has little resemblance to the actual fixture movement. As a consequence, the same fixture movement may look entirely different in Lightkey than in other apps.

❖ **Note:** This also means that you can't create some paths which look (on the screen) like a certain path in Cartesian coordinates. For example, you can't create a perfect circle because moving lights with a finite pan range can't (indefinitely) move in a circle. In such a situation, think about how you want the fixture to move and create your path accordingly. Lightkey allows you to build any movement path that can be created in a Cartesian coordinate system.

Lightkey comes with a set of built-in movement paths which you can freely edit and build upon. Whenever you change a built-in path, Lightkey creates a copy. Those self-created paths are stored in the project.

❖ **Note:** Another way to create fixture movements are sequences, as described in [Create fixture movements with sequences](#) in chapter 9, [Presets and sequences](#). Each technique has its advantages and drawbacks. A movement effect is quick to create, easy to reuse on different fixtures, and provides a better visual impression of how the fixtures move. On the other hand, a sequence lets you combine the movement with other fixture properties and gives you more control over timing.

## Add an effect

- 1 Select one or more fixtures for the effect. Make sure the fixtures' light beams are visible (that is, their shutters and dimmers are open).
- 2 Do one of the following:
  - ▶ Click  in the toolbar and choose a fixture property from the menu.
  - ▶ Choose Fixture → Add Effect, then choose a fixture property (or press Command-Option-E).
  - ▶ Click a fixture property's name in the Design view or in a property's HUD and choose Add [property name] Effect... from the menu.

### 3 Select the appropriate options in the area below the Preview.

To start from an effect template:

- ▶ Click one of the available templates. When a template is selected, Lightkey shows a preview of the effect. Templates which don't apply to the selected fixtures appear gray.
- ▶ The  icon indicates that an effect is beat-controlled.
- ▶ Enter text in the search field at the top-right to filter the displayed templates by name.
- ▶ Move the pointer over an effect template and click Add to add the effect to the selected fixtures. You can edit the effect's properties later.

To add a custom effect:

- ▶ Click Custom Effect.
- ▶ Select a fixture property and the kind of effect. The available effect types depend on the fixture property you selected.
- ▶ Click Add Effect.

### 4 If there's already an effect for the same fixture property, an alert message appears.

- ▶ Click Replace to replace the existing effect.
- ▶ Click Overlay to overlay the new effect with the existing one. See [Overlay effects](#) later in this chapter.

Lightkey adds the effect to the selected fixtures and shows its settings in the area below the Preview.



## Edit an effect

When a fixture property is controlled by an effect, the fixture property's area in the Design view shows an effect icon instead of the normal controls. You can edit an effect's settings at any time.

### Edit an effect

Do one of the following:

- ▶ Click the  icon in the Design view.

- ▶ Click a fixture's name in the Preview, then select a fixture property from the shortcut menu. Properties with an effect are marked with an  icon.
- ▶ Click Overrides in the toolbar. The names of the overridden properties appear next to the fixtures' icons, and an  icon marks properties with an effect. Click a fixture property's name to edit the effect.

When you edit an effect, Lightkey displays its settings in the area below the Preview. They are described in the following sections.

## Edit effect timing

Effects continue to loop until they're deactivated—they don't have an end point. Their speed is determined by a fixed duration or the beat.

You can choose between multiple timing modes for effects:

- **Fixed duration:** The effect has a fixed duration after which it repeats. You can change the duration in the Duration field. When you add an effect to a cue, the duration is multiplied by the cue's Speed modifier.
- **Beat-controlled timing:** The effect runs in sync with the beat. You can choose a beat multiplier which controls how often the effect repeats per beat. For example, an effect with a beat multiplier of  $\div 2$  repeats twice during each beat. Beat synchronization is available for curve effects and some pattern effects.

For information on how to set the tempo and sync it to external sources see chapter 12, [Beat control](#).

- **Random timing:** Some pattern effects are entirely random so none of the preceding options applies to them.

You can set the timing options in the area below the Preview:

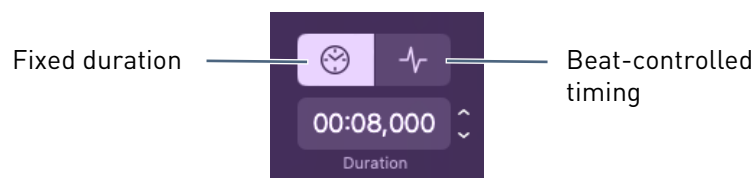

## Edit the fixture order

When you assign an effect to multiple fixtures or to fixtures with multiple beams (e.g. LED bars, strips, or matrixes), the order of the fixtures (or beams) has an important impact on the effect. In the following, the term **pixel** will be used for the smallest unit which can be individually controlled—either a fixture or a group of beams which can be individually controlled.

You can change the order of the fixtures (or beams) when you edit an effect. You can also add fixtures to the effect or remove them.

### Change the order of fixtures (or beams) for an effect

- 1 Edit an effect, then click Fixture Order in the area below the Preview.

As you move the mouse pointer over an item in the menu, Lightkey shows the resulting fixture order in the Preview.

- 2 Select an option as appropriate:

- **Left to Right:** Pass through pixels from left to right as they appear in the Preview.
- **Right to Left:** Pass through pixels from right to left as they appear in the Preview.
- **Top to Bottom:** Pass through pixels from top to bottom as they appear in the Preview.
- **Bottom to Top:** Pass through pixels from bottom to top as they appear in the Preview.
- **By Short Name:** Pass through fixtures alphabetically by their short name, either ascendingly or descendingly. Pass through beams by their index.
- **By Address:** Pass through fixtures by their universe and DMX address, either ascendingly or descendingly. Pass through beams by their index.
- **Random (Fixed):** Pass through pixels in a random order. The random order changes each time you select this option.
- **Random (Variable):** Pass through pixels in a random order. The random order changes each time the effect becomes active.
- **Consider Spacing:** When using one of the position-based options, consider the distances of the pixels in the Preview. Available for curve and movement effects.

- **Start to End:** Use the order as described above.
- **From Center:** Based on the order described above, pass through the pixels from the center to the edges. This option can't be used with random orders.
- **To Center:** Based on the order described above, pass through the pixels from the edges to the center. This option can't be used with random orders.
- **Select Fixtures:** Treat all beams of a fixture as a single pixel.
- **Select Beams:** For fixtures with multiple beams, treat each group of beams that can be individually controlled as an individual pixel.
- **Grouping:** Treat several adjacent pixels as a group that acts like a single pixel. For example (grouping set to 3): 1 / 1 / 1 / 2 / 2 / 2 / 3 / 3 / 3 / 4 / 4 / 4.
- **Repeat:** Repeat the effect after every 2nd, 3rd, 4th ... pixel. For example (repeat set to 3): 1 / 2 / 3 / 1 / 2 / 3 / 1 / 2 / 3 / 1 / 2 / 3.

### Change the fixtures that participate in an effect

- 1 Edit an effect, then click Fixture Order in the area below the Preview and choose Select Fixtures... from the menu.
- 2 Select or deselect fixtures in the Preview. Effects always apply to entire fixtures.
- 3 Click Done.

### Edit pattern effects

Pattern effects generate a repeating or random pattern from a set of predefined samples. Depending on the fixture property, a **sample** is either an intensity value (0–100%) or a color.



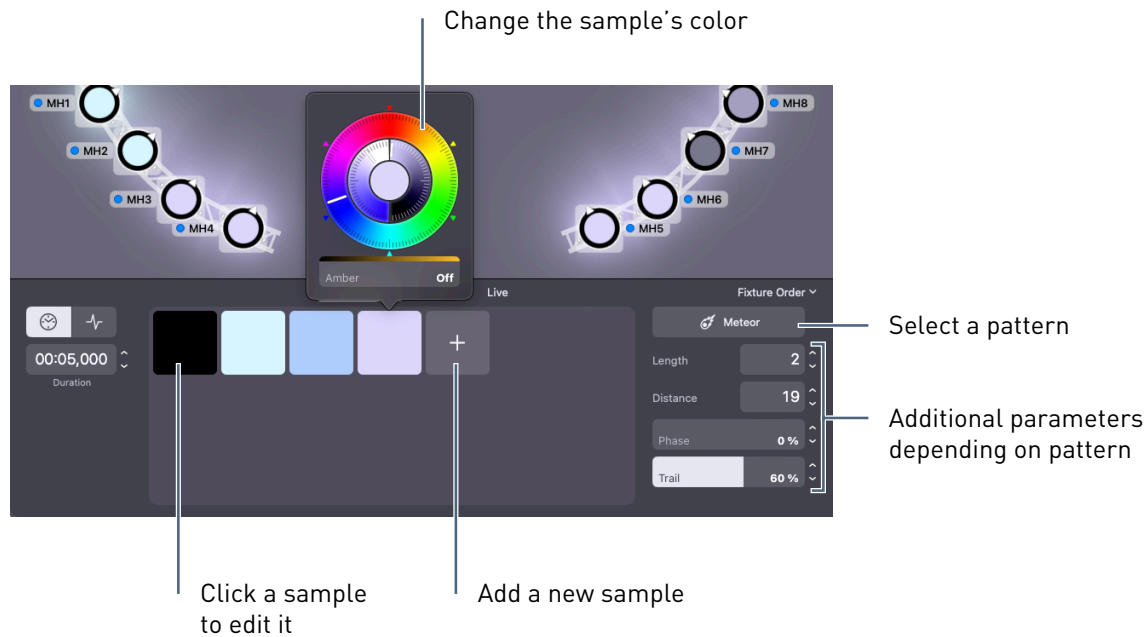

## Reorder the samples

- ▶ Drag a sample to the left or right.

## Duplicate a sample

Do one of the following:

- ▶ Control-click a sample and choose Duplicate from the shortcut menu.
- ▶ Hold down the Option key and drag the sample to the left or right.

## Delete a sample

Do one of the following:

- ▶ Control-click a sample and choose Delete from the shortcut menu.
- ▶ Drag the sample outside the samples area and release the mouse button.

The following sections describe the available patterns and their parameters.

## Chase

The pixels cyclically take on the value of each sample.

This pattern can be beat-controlled. In this case the chase is advanced on each beat (can be adjusted with beat multiplier).

<b>Steps per Value</b>	The number of chase steps before a pixel takes on the next value (see examples below).
<b>Phase</b>	Manual timing: Controls where the chase begins when the effect becomes active, relative to its duration. For example, a phase of 50% makes the chase begin half way through the duration.  This setting is especially useful when overlaying multiple effects.
<b>Time Offset</b>	Manual timing: Controls when the pixels change to the next value. A time offset of 0% means that all pixels change their value at the same time. Higher offsets mean that a pixel changes its value later than the preceding pixel (see <a href="#">Edit the fixture order</a> above).  This is similar to the Delay parameter except at the beginning of the effect (see examples below).
<b>Delay</b>	Manual timing: Introduces a delay for each pixel to change its value, relative to the preceding pixel. At the beginning of the effect each pixel starts at the first sample (see examples below).
<b>Smoothness</b>	A smoothness value greater than zero lets Lightkey blend between consecutive samples (see examples below).

**Example:** A chase pattern with four colors, no time offset or delay.

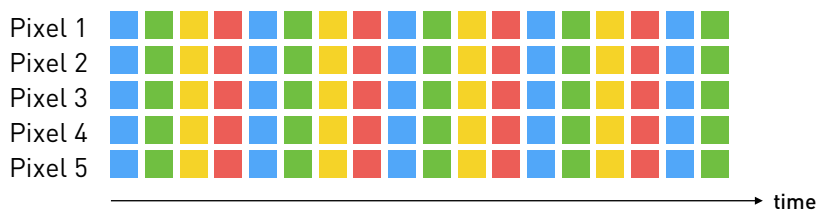

The chase with a time offset of 100%.

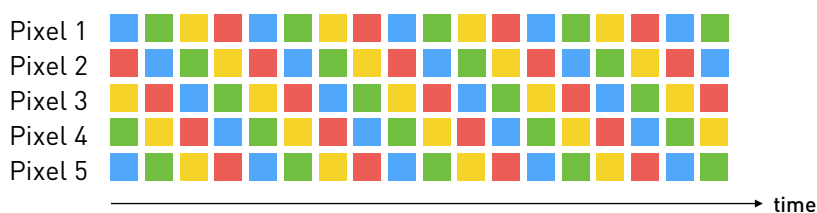

The original chase with a delay of 100%.

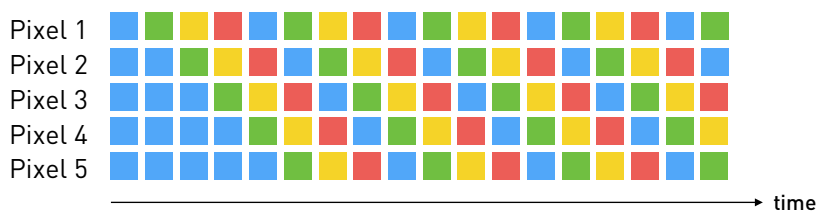



<b>Phase</b>	Manual timing: Controls where the pattern begins when the effect becomes active, relative to its duration. For example, a phase of 50% makes the pattern begin half way through the duration.  This setting is especially useful when overlaying multiple effects.
<b>Center</b>	Controls the ratio between filling and clearing the pixels.
<b>Steepness</b>	Controls the pacing of the pattern. With a steepness of 0% pixels are filled in a linear fashion. With a larger steepness the animation becomes faster towards the end.

## Fill

Successively fills all pixels with one of the sample values. The first sample defines the background, the remaining samples are used in turn for filling.

**Example:** A fill pattern with a background color and two fill colors.

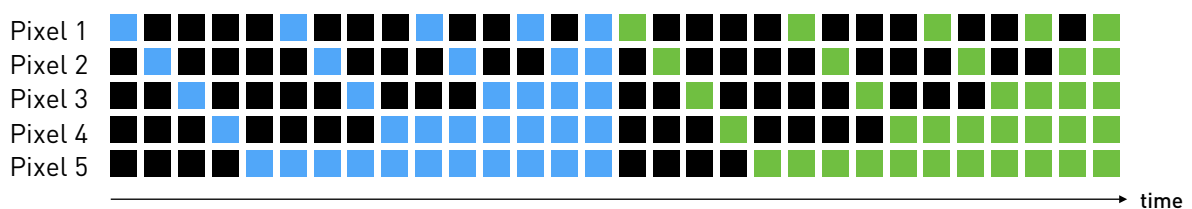

## Rain

Streaks of rain move at constant pace across a static background. The first sample defines the background, the remaining samples are used in turn for the streaks.

This pattern can be beat-controlled. In this case a new streak appears on each beat (can be adjusted with beat multiplier).

<b>Length</b>	The length of each streak (number of pixels).
<b>Distance</b>	The number of pixels between successive streaks.
<b>Phase</b>	Manual timing: Controls where the pattern begins when the effect becomes active, relative to its duration. For example, a phase of 50% makes the pattern begin half way through the duration.  This setting is especially useful when overlaying multiple effects.
<b>Fringe</b>	If greater than zero, each streak fades out towards the background.
<b>Noise</b>	Adds random noise when fading out the streaks. Use if fringe is greater than zero.

**Example:** A rain pattern with a background sample and two foreground samples (length = 4, distance = 2, fringe = 100%).

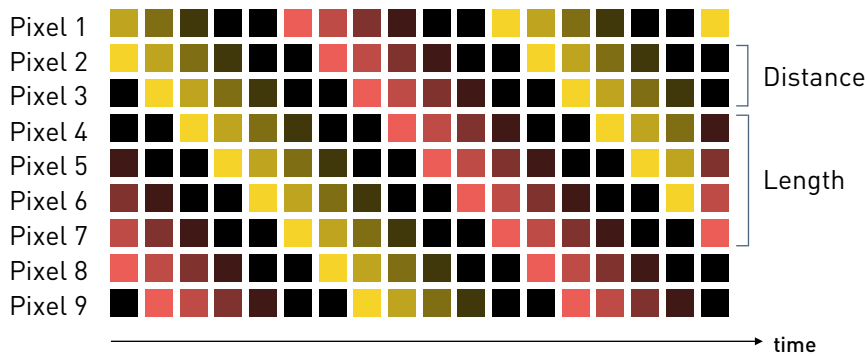

## Meteor

A series of “meteoroids” pass by, leaving a trail of particles which disintegrate in a random fashion. The first sample defines the static background, the remaining samples are used for the meteors.

This pattern can be beat-controlled. In this case a new meteoroid is launched on each beat (can be adjusted with beat multiplier).

<b>Length</b>	The length of each meteoroid (number of pixels), without the trail.
<b>Distance</b>	The number of pixels between successive meteoroids.
<b>Phase</b>	Manual timing: Controls where the pattern begins when the effect becomes active, relative to its duration. For example, a phase of 50% makes the pattern begin half way through the duration.  This setting is especially useful when overlaying multiple effects.
<b>Trail</b>	The length of the meteor’s trail.
<b>Use samples as palette</b>	If selected, the samples (except the background sample) are used as a palette for coloring the meteors.  If not selected, the non-background samples are used in turn for each meteor.

**Example:** A meteor pattern with two alternating foreground samples (length = 2, distance = 6).

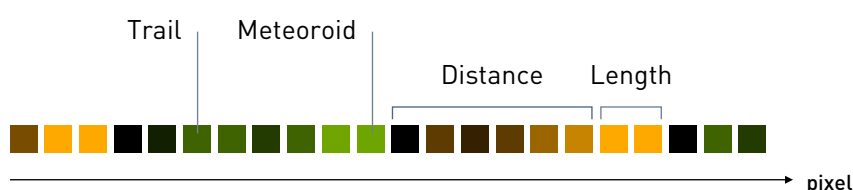

## Sparkle

Random pixels light up on a static background. The first sample defines the background, the remaining samples are used for the “sparkles”.

<b>Interval</b>	The time interval after which a new sparkle ignites (in seconds).
<b>Lifetime</b>	The time each sparkle remains visible (in seconds).
<b>Fringe</b>	If greater than zero, each sparkle fades out towards the background value.
<b>Noise</b>	Adds random noise when fading out the sparkles. Use if fringe is greater than zero.
<b>Use samples as palette</b>	<p>If selected, each sparkle will pass thru all samples (except the background sample) during its lifetime. In other words, the samples act like a palette for coloring the sparkles.</p> <p>If not selected, the non-background samples are used in turn for each sparkle.</p>

**Example:** A sparkle pattern with a background color and four foreground colors (fringe = 100%). The locations of new sparkles are chosen randomly.

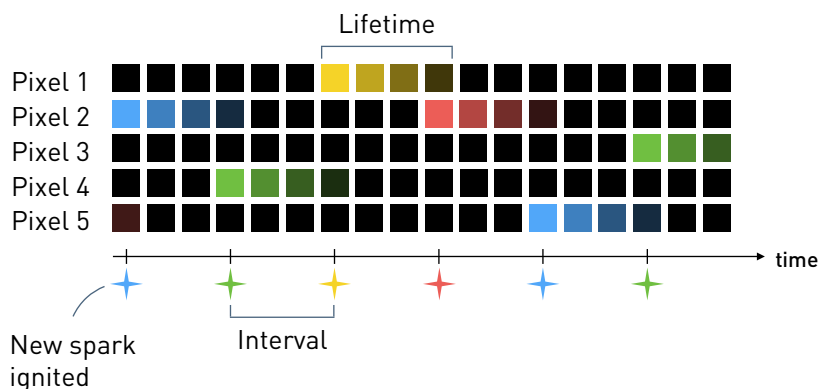

## Fire

Resembles a burning flame. The samples are interpreted as a color palette for the fire, with the “hottest” values towards the right. This pattern looks best on LED strips with 20 or more pixels.

<b>Speed</b>	Controls the speed of the effect.
<b>Sparkling</b>	Controls how fast a flame cools down. More cooling means shorter flames.

<b>Cooling</b>	Controls how often a new spark will ignite at the bottom of the fire. A higher value makes the fire more active.
----------------	------------------------------------------------------------------------------------------------------------------

## Jellyfish

Generates a pattern of elements which move along the pixels while pulsating like a jellyfish. The first sample defines the background, the remaining samples are used for the “jellyfish”. This pattern looks best on LED strips with 20 or more pixels.

<b>Count</b>	The maximum number of jellyfish visible at a time.
<b>Size</b>	Controls the size of the jellyfish.
<b>Speed</b>	Controls the speed by which the jellyfish move.
<b>Fringe</b>	Controls how the jellyfish fade out towards the edges.
<b>Use samples as palette</b>	<p>If selected, the samples (except the background sample) are used as a palette for colorizing the jellyfish.</p> <p>If not selected, the non-background samples are used in turn for each jellyfish.</p>

## Snakes

A series of variable-length “snakes” creeps along the pixels at constant pace. The lengths of the snakes and their distances are randomized. The first sample defines the background, the remaining samples are used in turn for the snakes.

<b>Length</b>	The minimum and maximum snake length.
<b>Distance</b>	The minimum and maximum distance between successive snakes.
<b>Speed</b>	Controls the speed by which the snakes move.
<b>Fringe</b>	Controls how the snakes fade out towards the edges.
<b>Noise</b>	Adds random noise when fading out the snakes. Use if fringe is greater than zero.

**Example:** A snakes pattern with a background color and two foreground colors. The lengths and distances are chosen randomly.



## Edit curve effects

Curve effects let you draw a curve which determines the fixture property's value at a given time. You can edit the curve in the area below the Preview. For fixture properties with multiple components (Color, Position), each component has its own curve.



### Select a built-in curve template

- ▶ Click Select Template..., then click one of the templates.

A curve is defined by a set of **control points**. The curve segments between the points can be either straight or curved.

### Select control points

- ▶ To select a single point, click the point.
- ▶ To select multiple points, press the mouse button over a blank part of the curve area and drag across the points.
- ▶ To toggle a point's selection state, hold down the Command key and click the point.
- ▶ To select a range of points, click the first point, then hold down the Shift key and click the last point in the range.
- ▶ To select all points, choose Edit → Select All (or press Command-A).



- ▶ To clear the selection, choose Edit → Deselect All (or press Command-Shift-A or Esc) or click a black part of the curve area.
- ▶ To select the points one by one from left to right, press Control-Tab. To select from right to left, press Control-Shift-Tab.

### **Move control points**

- ▶ Drag a point to move it. You can select multiple points to move them at once. As you drag, Lightkey shows alignment guides that help with precise positioning, and snaps to gridlines and other points.
- ▶ To disable alignment guides and snapping, hold down the Control key as you drag.
- ▶ To constrain the motion to horizontal or vertical, hold down the Shift key as you drag.
- ▶ To move points in small steps, select one or more points and press one of the arrow keys. To move the points in larger steps, hold down the Shift key while pressing an arrow key.

### **Add or remove control points**

- ▶ To add a point, place the pointer over the curve and click the transparent handle which appears between two points.
- ▶ To add a point under the mouse, place the pointer over the curve, hold down the Option key, and then click.
- ▶ To remove one or more points, select them and press the Delete key. You can also Control-click a point and choose Delete from the shortcut menu.

### **Make a segment straight and curved**

- ▶ To toggle a curve segment between a straight line and a curve, place the pointer over the segment and double-click. You can also Control-click the segment and choose Straight or Curved from the shortcut menu.
- ▶ Double-click a control point to toggle the adjacent curve segments between straight lines and curves.

## Transform control points or the entire curve

- 1 Select three or more control points. If no points are selected the entire curve will be transformed.
- 2 Control-click and choose Transform Points or Transform Curve from the shortcut menu (or press T).

A blue outline with handles appears around the control points.

- 3 To scale the points:
  - ▶ Drag one of the four blue handles at the edges of the blue outline to scale the points along the horizontal or vertical axis.
  - ▶ Hold down the Option key as you drag to scale from the center.
  - ▶ To disable alignment guides and snapping, hold down the Control key as you drag.

To move the points:

- ▶ Place the pointer over the blue outline and drag.

- 4 Click outside the blue outline or press Return or Esc to exit transform mode.

## Flip control points or the curve horizontally or vertically

- 1 Select a range of two or more control points. If no points are selected the entire curve will be flipped.
- 2 Control-click and choose Flip Horizontally or Flip Vertically from the shortcut menu.

## Copy and paste a curve

- 1 While editing a curve effect, choose Edit → Copy (or press Command-C).
- 2 Go to another curve effect or select a different color component.
- 3 Choose Edit → Paste (or press Command-V).

Lightkey shows an animated dot on the curve which reflects the location at the current time. Multiple dots appear if the effect has multiple pixels and a time offset. (No dots are shown when a control point is selected or while transforming the curve.) You can disable this animation if you find it distracting.

## Hide or show the current location

- ▶ Control-click over a blank part of the curve area and choose Hide/Show Current Location.

The horizontal axis below the curve can either display percentage values from 0 to 100% or exact times if the effect has a fixed duration. For beat-controlled effects it always displays a percentage.

## Configure the horizontal axis

- ▶ Click the labels below the curve to toggle between percent and time. You can also Control-click the labels and choose Percent or Time from the shortcut menu.
- ▶ If you selected Percent, you can choose the number of subdivisions: Control-click the labels and choose Subdivisions from the shortcut menu, then select the desired number.

Additional options appear to the right of the curve:

---

<b>Select Template...</b>	Select one of the built-in curve templates.
<b>Time Offset</b>	<p>Time offset between two consecutive fixtures (or beams), in percent of the effect's duration. For example, with a duration of 10 seconds and a time offset of 5%, the second fixture will perform the effect 0.5 seconds later than the first, the third fixture will be 1 second later than the first, and so on. See <a href="#">Edit the fixture order</a> above.</p> <p>To evenly distribute the time offset across the pixels, Control-click the Time Offset slider and choose Spread Evenly from the shortcut menu.</p>

---

Some options are available for the Position property only. To change them, click the Options button in the lower-left.

---

<b>Mirror pan</b> <b>Mirror tilt</b>	If you use the "From Center" fixture order option (see <a href="#">Edit the fixture order</a> above), Lightkey can "mirror" the pan and/or tilt angles on one side of the center (that is, reverse their sign). Here's an example of mirrored pan angles: $-30^\circ / -15^\circ / 0^\circ / +15^\circ / +30^\circ$ .
<b>Relative</b>	If you select this option, the effect's pan and tilt values are added to the pan/tilt values defined elsewhere. For example, you could have two cues active at the same time: One cue defines "absolute" positions for some fixtures and the other adds a relative effect "on top".

---

## Edit movement effects

Movement effects define the pan and tilt movement of a moving light using movement paths (or simply paths). When you edit a movement effect, the built-in and user-created movement paths appear in the area below the Preview. Click a path to use it for the effect. Movement paths are stored independently of the effect, so you can reuse them for other effects.

If you edit a movement path later, the changes will affect all effects and fixtures to which the path was applied. You can prevent this by duplicating the path before editing it. When you begin editing a built-in path Lightkey automatically duplicates it.

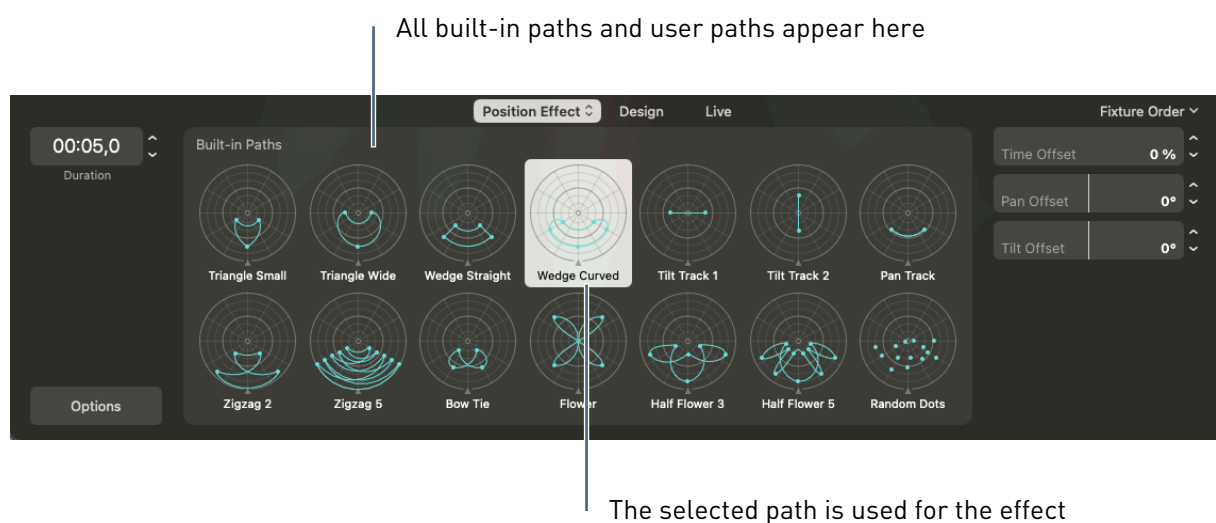

### Duplicate a path

- 1 Do one of the following:
  - ▶ Click a path to select it, then choose Edit → Duplicate (or press Command-Shift-D).
  - ▶ Control-click a path and choose Duplicate from the shortcut menu.
- 2 Type a name for the new path and press Return.

### Rename a user path

- 1 Do one of the following:
  - ▶ Click a path to select it, then choose Edit → Rename.
  - ▶ Control-click a path and choose Rename from the shortcut menu.
  - ▶ Select a path and press Return.

- 2 Type a new name for the path and press Return.

You cannot rename the built-in movement paths.

### Delete a user path

- 1 Do one of the following:
  - ▶ Click a path to select it, then choose Edit → Delete.
  - ▶ Control-click a path and choose Delete... from the shortcut menu.
  - ▶ Press Delete.
- 2 In the dialog that appears, click Delete.

The following table describes the options for movement effects.

<b>Time Offset</b>	Time offset between two consecutive fixtures, in percent of the effect's duration. For example, with a duration of 10 seconds and a time offset of 5%, the second fixture will perform the movement 0.5 seconds later than the first, the third fixture will be 1 second later than the first, and so on. See <a href="#">Edit the fixture order</a> above.  To evenly distribute the time offset across the pixels, Control-click the Time Offset slider and choose Spread Evenly from the shortcut menu.
<b>Pan Offset</b>	Adds an offset (in degrees) to the pan angle between two consecutive fixtures. For example, if the pan offset is 10° then the pan angle of the second fixture will always be 10° larger than the pan angle of the first, and the pan angle of the third fixture will be 20° larger than the pan angle of the first, and so on. See <a href="#">Edit the fixture order</a> above.
<b>Tilt Offset</b>	Adds an offset (in degrees) to the tilt angle between two consecutive fixtures.

Additional options are shown when you click the Options button in the lower-left:

<b>Mirror pan</b> <b>Mirror tilt</b>	If you use the "From Center" fixture order option (see <a href="#">Edit the fixture order</a> above), Lightkey can "mirror" the pan and/or tilt angles on one side of the center (that is, reverse their sign). Here's an example of mirrored pan angles: -30° / -15° / 0° / +15° / +30°.
<b>Relative</b>	If selected, the effect's pan and tilt values are added to the pan/tilt values from cues with a lower priority. For example, you could have two cues active at the same time: One cue defines "absolute" positions for some fixtures and the other adds a relative effect "on top".

All built-in and self-created movement paths are fully editable: For example, you can move, add, and remove points as well as flip or transform the path. When you edit a built-in path, a copy is created.

Whenever you make a mistake as you edit a path, you can choose Edit → Undo to undo the last change.

## Begin editing a movement path

Do one of the following:

- ▶ Move the pointer over the selected path and then click Edit.
- ▶ Click one of the effect's fixtures in the Preview.

The Position HUD appears and shows the movement path.

## Edit paths

Every movement path consists of two or more **control points**. The point where the movement starts is marked with a dot.

You can select one or more control points. When you select a point, the fixtures move to the corresponding position and follow it as you move the point. When you clear the selection, the fixture resumes moving along the path from there.

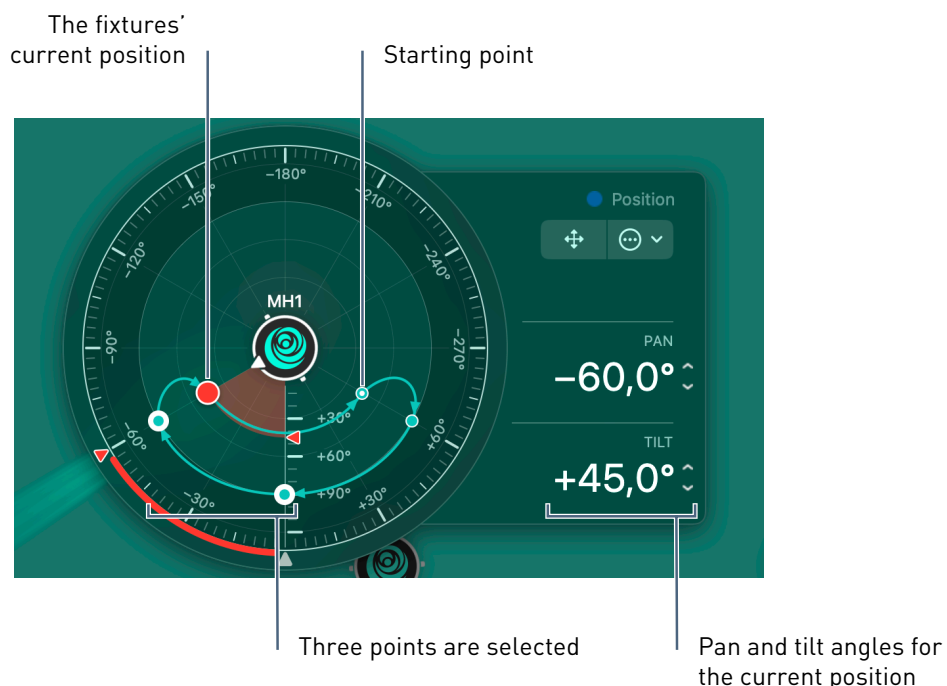

## Select control points

- ▶ Click a point to select it.
- ▶ To select the next point in movement order, press Tab. To select the previous point, press Shift-Tab.
- ▶ To select a range of points, click the first point, then hold down the Shift key and click the last point (in movement order).
- ▶ To toggle a point's selection state, hold down the Command key and click the point.
- ▶ To select multiple points, press the mouse button over a blank part of the position control and drag across the points.
- ▶ To select all points, choose Edit → Select All (or press Command-A).
- ▶ To clear the selection, choose Edit → Deselect All (or press Command-Shift-A or Esc) or click a black part of the position control.

## Move control points

- ▶ Drag a point to move it. You can select multiple points to move them at once. As you drag, Lightkey shows alignment guides that help with precise positioning, and snaps to certain positions and other control points. You can press modifier keys to change the behavior:
  - ▶ To lock the current pan angle, hold down the Command key.
  - ▶ To lock the current tilt angle, hold down the Shift key.
  - ▶ To disable snapping, hold down the Control key.
- ▶ To move points in steps of 1°, select one or more points and press one of the arrow keys. The Left/Right Arrow keys change pan and the Up/Down Arrow keys change tilt. Hold down the Shift key to move in 10° steps, or the Command key to move in 0.1° steps.
- ▶ Another way to move points is to select one or more points and then scroll to change pan. (If scrolling has no effect, choose Lightkey → Settings..., click Gestures, and make sure "Scrolling changes slider and HUD values" is selected.) Hold down the Command key to change tilt. Hold down the Shift key to move faster or the Option key to move slower.
- ▶ You can also move control points with a joystick. The joystick's horizontal axis controls pan and the vertical axis controls tilt.

To deal with fixtures whose pan range exceeds 360° or to apply negative tilt angles, you can use the techniques described in [Position](#) in chapter 8, [Fixture properties](#).

### Add a control point

- ▶ If the path has connection lines between the points (Curve and Line types), move the pointer over a connection line and click the transparent handle which appears between the points.
- ▶ If the path has no connection lines (Points type), double-click anywhere in the position control.

### Remove control points

Do one of the following:

- ▶ Select one or more points, then press the Delete key.
- ▶ Control-click a point and choose Delete Point from the shortcut menu.

### Flip points

- ▶ To flip the pan or tilt angle of the selected points (e.g. from +50° to -50°), Control-click one of the selected points point and choose Flip Pan or Flip Tilt from the shortcut menu.
- ▶ To flip the entire path, click ☹ and choose Flip Pan Values or Flip Tilt Values from the menu.

### Change the starting point

- ▶ Control-click a point and choose Make Starting Point from the shortcut menu.

### Reverse the points in a path

- ▶ Click ☹ and choose Reverse Path from the menu.

Lightkey shows an animated dot on the path which reflects the fixture position at the current time. Multiple dots appear if the effect has multiple fixtures and a time offset. You can disable this animation if you find it distracting.

### Hide or show the current location

- ▶ Click ☹ and choose Hide/Show Current Location from the menu.



## Path types

There are three different ways how Lightkey can interpolate the path positions between the control points. The following graphs illustrate these types for a movement path with four control points. In the graphs, the vertical dimension represents the fixture position (which actually consists of two dimensions, pan and tilt).

- **Smooth:** The fixture moves smoothly between the control points. The time for moving from one point to the next depends on the distance between the points.

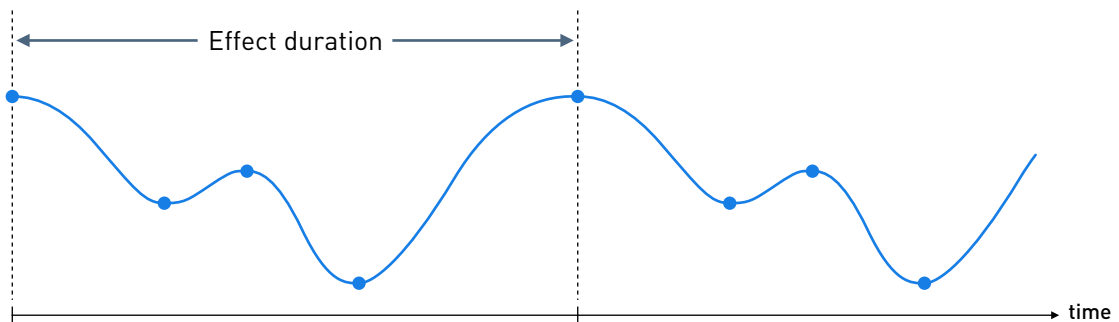

- **Line:** The fixture moves on the direct way from one control point to the next, changing its movement direction at each control point. The time for moving from one point to the next depends on the distance between the points.

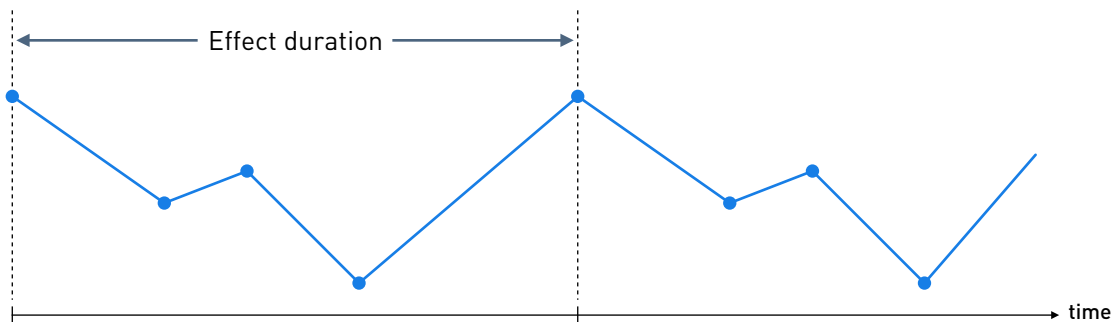

- **Points:** The fixture moves instantly from one control point to the next, with maximum speed. It remains at each control point for an equal time. (This is often used together with the “Blackout during pan/tilt movement” feature of many moving lights.)

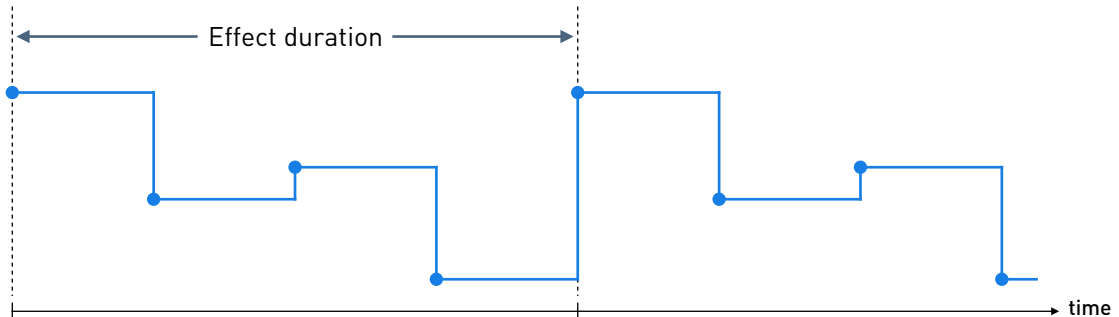

### Change a path's type

- ▶ Click ☺ and choose Curve, Lines, or Points from the menu.

### Transform paths

In transform mode you can move or scale the entire path in pan or tilt direction.

#### Transform a path

- 1 Click ⇄ (or press T) to enter Transform mode.  
A blue outline with handles appears around the control points.
- 2 Do one of the following to move the path:
  - ▶ Hold down the Shift key and drag around the center to move the path along the pan axis.
  - ▶ Hold down the Command key and drag away from the center or towards the center to move the path along the tilt axis.
  - ▶ If you don't press a modifier key, the path moves either in pan or tilt direction, depending on the mouse movement.
  - ▶ To disable snapping to certain pan or tilt angles, hold down the Control key as you drag.

- ▶ Place the pointer over the position control and scroll up or down to move the path along the pan axis. (If scrolling has no effect, choose Lightkey → Settings..., click Gestures, and make sure “Scrolling changes slider and HUD values” is selected.) Hold down the Command key as you scroll to move along the tilt axis. Hold down the Shift key to move faster or the Option key to move slower.
  - ▶ To move the path in steps of 1°, press one of the arrow keys. The Left/Right Arrow keys change pan and the Up/Down Arrow keys change tilt. Hold down the Shift key to move in 10° steps, or the Command key to move in 0.1° steps.
  - ▶ You can also move the path with a joystick. The joystick’s horizontal axis moves in the pan direction and the vertical axis moves in the tilt direction.
- 3 Drag one of the four handles at the edges of the blue outline to scale the path. Hold down the Option key to resize the path from its center. To disable snapping to certain pan or tilt angles, hold down the Control key as you drag.
  - 4 Click  again (or press T or Esc) to exit Transform mode.

## Copy and paste effects

Because an effect is like a special value for a fixture property, you can copy effects between fixtures in the same way as you copy fixture property values.

When you copy and paste an effect, the new effect is independent of the original one. If you want to add more fixtures to an effect instead, see [Edit the fixture order](#) earlier in this chapter.

### Copy an effect between fixtures

- 1 Select a single fixture with an effect.
- 2 Choose Edit → Copy Property, then choose a fixture property. An icon marks properties with effects.
- 3 Select one or more fixtures you want to apply the effect to.
- 4 Choose Edit → Paste Properties.

## Delete an effect

When you delete an effect, you can either keep the current values at the time the effect was deleted, or clear the entire fixture property so it's no longer defined.

Deleting an effect removes it from all fixtures. If you want to remove individual fixtures from an effect instead, see [Edit the fixture order](#) earlier in this chapter.

### Delete an effect and keep the current values

- ▶ While you're editing an effect, click the effect's name below the Preview and choose Delete Effect and Keep Values from the menu.

### Delete an effect

Do one of the following:

- ▶ While you're editing an effect, click the effect's name below the Preview and choose Delete Effect from the menu.
- ▶ If the fixture property appears in the Design view, select the fixtures and then click the blue dot to the left of the property's name in the Design view.
- ▶ Click  in the toolbar or choose Fixture → Clear Properties for All Fixtures (or press Command-Shift-Delete). This will also remove any other overridden properties from all fixtures.

## Overlay effects

You can overlay multiple effects for the same fixture property to create entirely new looks. If there are multiple effects for a fixture property, Lightkey adds their output values to determine the final output. If the values are colors, Lightkey uses the "screen" blend mode to blend the output colors of the individual effects.



### Overlay an existing effect with a new effect

- 1 Select one or more fixtures with an effect. Choose Fixture → Add Effect and choose a fixture property, then select a new effect for the same property (see [Add an effect](#) earlier in this chapter).
- 2 Click Add Effect.

- 3 In the alert message that appears, click Overlay.

### Overlay an effect by duplicating

- 1 Edit an effect.
- 2 Click the effect's name below the Preview and choose Duplicate from the menu.

A second effect is added with the same parameters. You can now modify the new effect's settings.

### Switch between multiple effects during editing

- ▶ Click the edited effect's name below the Preview and choose a different effect from the menu.

## Save an effect template

You can save an effect as a template which appears in the Effects Chooser so you can quickly select it for new effects. Effect templates are part of the project.

### Save an effect as a template

- 1 Edit an effect.
- 2 Click the effect's name below the Preview and choose Save as Template... from the menu.
- 3 In the dialog that appears, enter a name for the template. To include the settings from the Fixture Order menu in the template, select "Include fixture order".
- 4 Click Save.

### Rename an effect template

- 1 Choose Fixture → Add Effect, then choose a fixture property to open the Effects Chooser.
- 2 Control-click an effect template and choose Rename from the shortcut menu.
- 3 Type a new name, then press Return.

## Delete an effect template

- 1 Choose Fixture → Add Effect, then choose a fixture property to open the Effects Chooser.
- 2 Control-click an effect template and choose Delete... from the shortcut menu.
- 3 In the dialog that appears, click Delete.

You can't delete or rename the built-in effect templates.

# Chapter 11

## Live control

---

The Live view lets you build a custom-tailored control panel for your show. Add buttons and faders to activate lighting cues on the fly, or a cuelist to recall cues in a predefined order.

The central element is a **cue**, which consists of a combination of presets and sequences from the Preset Palette. Cues either belong to a button in the Live view or are part of a cuelist.

### Live view pages

The Live view can have multiple **pages**, but only one of them is visible at a time. Only the cues on the current page have an effect on the output. Depending on your needs you might create separate pages for different occasions, users, or songs being performed, for example.

The Live view is the central place for running your show, but it's still possible to override fixture properties on the fly or activate presets and sequences. Overridden properties always take precedence over active cues, presets, and sequences.

### Show the Live view

Do one of the following:

- ▶ Click Live below the Preview.
- ▶ Choose View → Live (or press Command-L).

★ **Tip:** If you have a second display—or a touch screen—connected to your Mac you can move the Live view to the second display. See [Dual windows](#) in chapter 6, [The Lightkey window](#), for more information.

## Manage Live view pages

1 Do one of the following:

- ▶ Choose Live → Manage Live Pages... (or press Command-Shift-Option-L).
- ▶ Click Live at the top of the Live view and choose Manage Live Pages... from the menu.

2 In the dialog that appears, make changes as appropriate:

- ▶ **To add a page:** Click + and choose an item from the menu. Enter a name for the new page and press Return.
- ▶ **To reorder the pages:** Drag the rows in the list up or down.
- ▶ **To rename a page:** Select the page, then click ⋮ and choose Rename from the menu. Alternatively, select the page and click its name. Type a new name and press Return.
- ▶ **To change a page's fade time:** Select a page and click in the Fade Time column. Type a new value and press Return.
- ▶ **To duplicate a page:** Select a page, then click ⋮ and choose Duplicate from the menu. Enter a name for the new page and press Return. This will also duplicate any external control bindings for the page.
- ▶ **To delete a page:** Select the page and click — or press the Delete key, then click Delete in the dialog that appears. This will also delete any external control bindings for the page.

3 Click Done.

You can change the default fade time which is used for new Live pages. Changing this value will not affect existing pages.

## Change the fade time for new Live pages

- 1 Choose Lightkey → Settings... (or press Command-Comma) and click Timing.
- 2 Change the value for “Live page: Fade time”.



## Switch between pages

- ▶ Click Live at the top of the Live view, then select a page from the menu.

When you switch away from a page, the cues on that page no longer have an effect on the output. Lightkey remembers the active cue buttons and restores them when you return to the page. If you prefer the cues to be deactivated you can change the behavior in Lightkey's settings.

## Deactivate cues before switching pages

- 1 Choose Lightkey → Settings... (or press Command-Comma) and then click General.
- 2 Select "Deactivate cues before switching pages".

## Build Live view pages

A page can contain an unlimited number of **buttons** which you can freely arrange, style, attach, and place in frames. Each button is associated with a **cue**. You can also add a cuelist and text labels.

There are two types of buttons:

- **Push button:** A push button simply activates or deactivates a cue.
- **Fader:** A fader lets you control a cue's intensity between 0% and 100%, like on a traditional lighting console. The intensity determines to what degree a cue affects the fixtures' properties. There are horizontal and vertical faders.

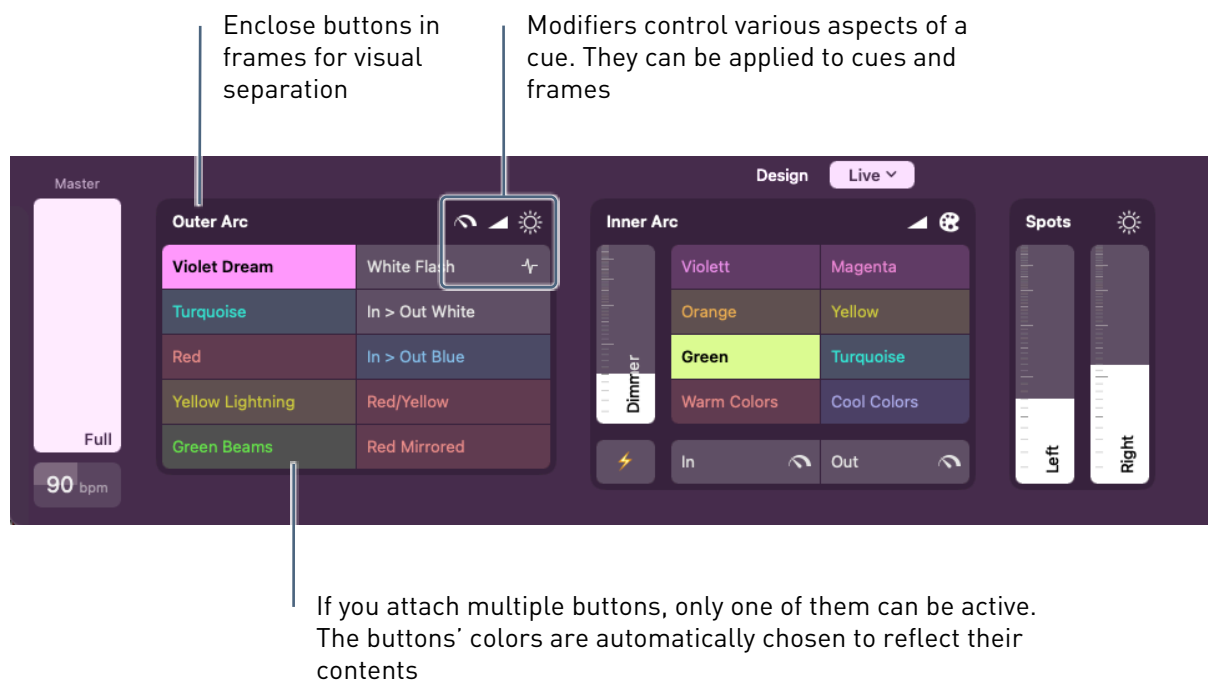

See [Live view pages](#) earlier in this chapter to learn how to create a page.

## Edit a page

Enter edit mode to change the objects on the current page.

### Enter or exit edit mode

Do one of the following:

- ▶ To enter edit mode, click Edit at the top-right of the Live view. To exit edit mode, click Done.
- ▶ Choose View → Edit Live View (or press Command-Option-J).
- ▶ Control-click a blank part of the Live view and choose Edit Live View from the shortcut menu.
- ▶ Hold down the Command key and double-click a blank part of the Live view.
- ▶ Press Command-Return to exit edit mode.

While the Live view is in edit mode, a grid is shown in the background which helps you to align objects. You can hold down the Space bar and drag to pan the Live view area. The remainder of this section assumes that the Live view is in edit mode.

## Add cue buttons

When you create a cue button, Lightkey automatically adds the active presets and sequences to its cue. If there are overridden fixture properties, it also adds a special preset named “Ad hoc properties” which contains those properties. This preset is special because it doesn’t appear in the Preset Palette.

### Add a button

- 1 Do one of the following:
  - ▶ Choose Live → New Button.
  - ▶ Control-click a blank part of the Live view and choose New Button from the shortcut menu.
  - ▶ While the Live view is in edit mode, click + at the top-right of the Live view.

The Live view changes to edit mode and a new button is added. The cue inspector appears on the right of the Live view, showing the cue’s contents and other options.

- 2 Type a name for the button, then press Return.
- 3 Drag presets and sequences from the Preset Palette to the upper part of the cue inspector.
- 4 Edit the button’s other properties in the inspector, as described in [Edit cue contents and options](#) later in this chapter.

### Create a button from one or more presets and sequences

- ▶ Select one or more presets and/or sequences in the Preset Palette and drag them to a blank part of the Live view. Drag the presets or sequences onto a frame (but not onto a button) to create a new button inside the frame.

Lightkey creates a new button which contains the dragged objects.

### Create multiple buttons from presets and sequences

- 1 Select several presets and/or sequences in the Preset Palette.
- 2 Drag the presets or sequences to a blank part of the Live view. Hold down the Command key when the pointer is over the Live view.

Lightkey creates a new cue button for each dragged object.

You can change the button's name at any time.

### **Rename a button**

- 1 Click a button to select it.
- 2 Do one of the following:
  - ▶ Click the button's name.
  - ▶ Select the button and choose Edit → Rename (or press Return).
  - ▶ Control-click the button and choose Rename from the shortcut menu.
- 3 Type a new name and then press Return.

[Set default styles](#) later in this chapter describes how to change the initial size, font, alignment, and color for new buttons.

### **Add text labels**

- 1 Do one of the following:
  - ▶ While the Live view is in edit mode, click T at the top-right of the Live view.
  - ▶ Choose Layout → Insert → Text.
  - ▶ Control-click a blank part of the Live view and choose Insert Text from the shortcut menu.
- 2 Drag the text label to where you want it.
- 3 Double-click the text label to begin editing, then type. To start a new line, press Option-Return.
- 4 Click outside the text label or press Return to finish editing.

To edit an existing text label, double-click the text label or select it and press Return.

[Set default styles](#) later in this chapter describes how to change the initial font and alignment for new text labels.

### **Select objects**

The following actions pertain to buttons, text labels, and cuelists.

## Select and deselect objects

- ▶ To select a single object, click it.
- ▶ To select additional objects, hold down the Shift key and click each object.
- ▶ To remove an object from the selection, hold down the Shift key and click the selected object.
- ▶ To select multiple objects at once, press the mouse button over a blank part of the Live view and drag it over the objects. (Hold down the Option key to select outward from the starting point.)
- ▶ To add or remove multiple objects to/from the selection, hold down the Shift key, press the mouse button over a blank part of the Live view, and drag it over the objects.
- ▶ To select all objects in the Live view, choose Edit → Select All (or press Command-A).
- ▶ To deselect all objects in the Live view, choose Edit → Deselect All (or press Command-Shift-A or Esc) or click a blank part of the Live view.

When an object is selected, it shows handles at its corners and edges.

## Move objects

You can freely arrange buttons, text labels, and cue lists in the Live view.

### Move objects in the Live view

- ▶ Press the mouse button over an object and drag it to a new location. To move multiple objects, select the objects and then drag them to a new location.  
By default, objects snap to the grid in the background as you drag. Lightkey also shows smart alignment guides that help you to precisely align them.
- ▶ To disable alignment guides and grid snapping, hold down the Control key as you drag.
- ▶ To constrain the motion to horizontal or vertical, drag the object(s) while holding down the Shift key.
- ▶ To move the objects by one grid unit, select the objects and press one of the arrow objects. To move objects by five units, hold down the Shift key and then press an arrow key.

## Attach buttons

By default you can activate as many buttons as you like, independent of each other. You can attach buttons so they form a group where only one button can be active at a time.

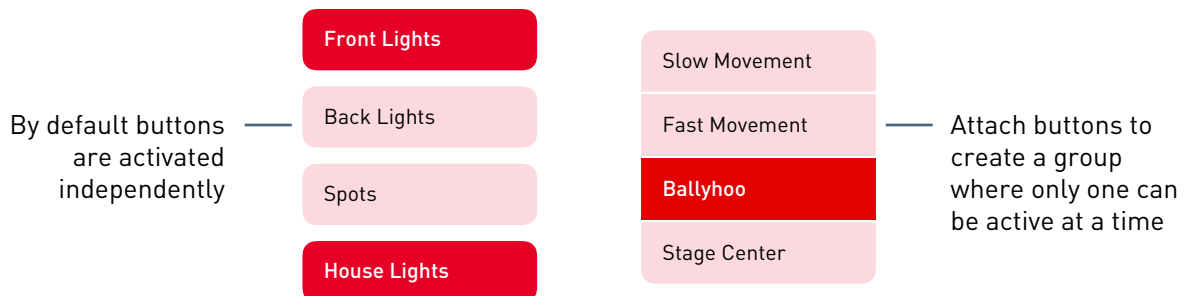

## Attach buttons

- ▶ Move two or more buttons together so their borders touch (see [Move objects](#) above).

## Detach a button from others

- ▶ Move the button away from the others.

❖ **Note:** When you switch between attached buttons, Lightkey performs a crossfade between the cues. This creates a smoother transition than fading the cues out and in independently. For best results, attached buttons should have identical fade times and curves, and the fade-out curve should match the (inverted) fade-in curve.

## Resize objects

You can freely resize the buttons, text labels, and cuelists in the Live view. You can even resize multiple objects at once.

## Resize objects

- ▶ Select one or more objects and then drag one of the blue selection handles. To resize the objects in one direction, drag a side handle instead of a corner handle.
- ▶ To resize the objects from their center, press the Option key as you drag.

- ▶ To disable alignment guides, hold down the Command key while you resize objects.

## Duplicate objects

You can duplicate buttons and text labels, which creates an independent copy. You can't duplicate cue lists because a Live view page can only have one cue list.

- 1 Done one of the following:
  - ▶ Select the object and choose Edit → Duplicate (or press Command-Shift-D).
  - ▶ Control-click the object and choose Duplicate from the shortcut menu.
  - ▶ Hold down the Option key while you drag an object.
- 2 After duplicating a button, type a name for the new button and then press Return.

## Copy and paste objects

You can copy buttons, text labels, and cue lists to the Clipboard and paste them either on the same page or a different one within the project. You can also copy and paste cues between buttons and cue lists.

### Cut or copy an object

Do one of the following:

- ▶ Select the object(s) and choose Edit → Cut or Edit → Copy (or press Command-X or Command-C).
- ▶ Control-click an object and choose Cut or Copy from the shortcut menu.

### Paste objects from the Clipboard

Do one of the following:

- ▶ Choose Edit → Paste (or press Command-V).
- ▶ Control-click anywhere in the Live view and choose Paste from the shortcut menu.

A Live page can only contain one cue list, so you can't paste a cue list if the page already contains one.

## Delete objects

- 1 Click an object to select it. (Hold down the Shift or Command key to select multiple objects.)
- 2 Do one of the following:
  - ▶ Choose Edit → Delete.
  - ▶ Control-click the object and choose Delete from the shortcut menu.
  - ▶ Press Delete.

If you accidentally deleted an object, choose Edit → Undo Delete.

## Frames

You can enclose related buttons in a frame and assign a title to it. Frames serve several purposes:

- They visually group the enclosed cue buttons.
- They let you run through the cue buttons in sequential order.
- You can add modifiers to a frame which change the output of all contained cues. See [Edit modifiers](#) later in this chapter.

### Create a frame

- 1 Select one or more buttons.
- 2 Do one of the following:
  - ▶ Choose Live → New Frame.
  - ▶ Click  near the top-right of the Live view.
- 3 Type a title for the frame, then press Return.

### Add cue buttons to an existing frame

Do one of the following:

- ▶ Drag one or more buttons onto a frame and release the mouse button.
- ▶ Drag one or more buttons over a frame and rest the mouse until the frame flashes. The frame is extended to include the dragged buttons, and you can continue to drag them to their final position.



## Remove buttons from a frame

Do one of the following:

- ▶ Select one or more buttons and choose Live → Remove from Frame.
- ▶ Control-click a button and select Remove from Frame from the shortcut menu.

If you remove all buttons from a frame, the frame disappears.

## Remove a frame

Do one of the following:

- ▶ Click a blank part of the frame to select it, then press Delete.
- ▶ Control-click a blank part of the frame and choose Delete from the shortcut menu.

## Change a frame's title

1 Do one of the following:

- ▶ Click a blank part of the frame to select it, then click the frame's title.
- ▶ Click a blank part of the frame to select it and choose Edit → Rename (or press Return).
- ▶ Control-click a blank part of the frame and select Rename from the shortcut menu.

2 Type a new title, then press Return.

You can add controls to a frame which, when clicked, activate the contained buttons in sequential order. The order is determined by the locations of the buttons in the frame.

## Add Previous/Next controls to a frame

1 Do one of the following:

- ▶ Click a blank part of the frame to select it and choose Live → Get Info (or press Command-I).
- ▶ Control-click a blank part of the frame and choose Get Info from the shortcut menu.
- ▶ Double-click a frame while the Live view is in edit mode.

The frame inspector appears on the right side of the Live view.

- 2 In the inspector, select “Previous cue” or “Next cue”.

Like buttons, frames have a priority which is relevant if multiple cues define the same fixture properties. See [Output order of precedence](#) later in this chapter for more information.

### Set a frame’s priority

- 1 Do one of the following:
  - ▶ Click a blank part of the frame to select it and choose Live → Get Info (or press Command-I).
  - ▶ Control-click a blank part of the frame and choose Get Info from the shortcut menu.
  - ▶ Double-click a frame while the Live view is in edit mode.

The frame inspector appears on the right side of the Live view.

- 2 Select a value from the Priority pop-up menu in the inspector.

### Change text formatting

You can change fonts, font sizes, and other text attributes for text labels, buttons, and frames. This works similarly to many other Mac applications.

### Change the formatting of an object

- 1 Select one or more objects.
- 2 Do one of the following:
  - ▶ Choose Edit → Font → Show Fonts. Select a font, font size, and other options in the Font window.
  - ▶ Choose Edit → Font → Bold, Italic, or Underline to change the text style.
  - ▶ Choose Edit → Font → Show Colors, then select a color in the Color window. (This applies to text labels only.)
  - ▶ Choose Edit → Alignment, then choose one of the options in the submenu to change the text alignment.

★ **Tip:** Another way to access the formatting menu options is to control-click an object. You can also change the text alignment in the cue and frame inspector.

## Set default styles

You can change the default style that is used for new cue buttons, frames, and text labels. This includes the font, text alignment, color, and size (for buttons). Each project has its own set of default styles.

### Set the default style for new objects

- 1 Select a single cue button, frame, or text label whose style you want to become the new default.
- 2 Do one of the following:
  - ▶ Choose Edit → Set Default Style.
  - ▶ Control-click the object and choose Set Default Style from the shortcut menu.

The style will be applied to new objects of the same kind (button, frame, or text label) in the project.

### Reset the default style to the original state

- 1 Select a single cue button, frame, or text label.
- 2 Hold down the Option key and choose Edit → Reset Default Style.

This resets the project's default style for the selected kind of object (button, frame, or text label) to the original state.

## Cuelists

A **cuelist** lets you recall cues in a fixed order during a show. It contains a series of cues which can be arranged in groups for a better overview. Cuelists are best used if you want to preprogram an entire show with no or minimal interventions during performance.

At most one cue in a cuelist is active at any time. When the cuelist runs you advance to the next cue by pressing the Space bar or dragging the Xfade slider. Or you can set a hold time after which the cuelist automatically activates the next cue. The transition between subsequent cues can be immediate or with a crossfade.

It is often useful to number cues so you can quickly refer to them. To do this simply add a number before the cues' names, e.g. "001 My cue". When you add a new cue or duplicate a cue, Lightkey automatically increments the new cue's number.

One way to create a cuelist is to add a new Live view page and choose the Cuelist option, as described in [Live view pages](#) earlier in this chapter. You can also add a cuelist to an existing page.

### Add a cuelist to an existing page

- 1 Do one of the following:
  - ▶ Choose Layout → Insert → Cuelist.
  - ▶ Control-click a blank part of the Live view and choose Insert Cuelist from the shortcut menu.
- 2 Move and resize the cuelist as appropriate. Lightkey will automatically enlarge the cuelist to fit the Live view when you exit edit mode.

A Live view page can't contain more than one cuelist.

Like buttons and frames, cuelists have a priority. If the Live page also contains cue buttons, the priority determines whether the cuelist or the buttons take precedence. See [Output order of precedence](#) later in this chapter for more information.

### Set a cuelists's priority

- 1 Do one of the following:
  - ▶ Click the cuelist to select it and choose Live → Get Info (or press Command-I).
  - ▶ Control-click the cuelist and choose Get Info from the shortcut menu.
  - ▶ Double-click a cuelist while the Live view is in edit mode.

The cuelist inspector appears on the right side of the Live view.

- 2 Select a value from the Priority pop-up menu in the inspector.

You can choose between two text sizes for cuelists and hide some of their elements if you don't need them. You can also decide if a cuelist should repeat after reaching the last cue.

### Change other cuelist options

**1** Do one of the following:

- ▶ Click the cuelist to select it and choose Live → Get Info (or press Command-I).
- ▶ Control-click the cuelist and choose Get Info from the shortcut menu.
- ▶ Double-click a cuelist while the Live view is in edit mode.

The cuelist inspector appears on the right side of the Live view.

**2** Change the options in the inspector as appropriate:

- **Size:** Choose one of two text sizes.
- **+ – buttons:** Deselect to hide the buttons for adding and removing cues in each row.
- **Xfade slider:** Deselect to hide the slider for manual crossfades.
- **Loops:** If selected, the cuelist will repeat after reaching the last cue.

## Edit cuelists

Before you can add cues to a cuelist you need to exit the Live view's edit mode. Click Done at the top-right of the Live view or press Command-Option-J.

## Add cues

When you create a cue, Lightkey automatically adds the active presets and sequences to the cue. If there are overridden fixture properties, it also adds a special preset named "Ad hoc properties" which contains those properties. This preset is special because it doesn't appear in the Preset Palette.

### Add a cue

**1** Do one of the following:

- ▶ Click + next to an item in the cuelist. A new cue is inserted below the item. (To insert a cue above the clicked item, hold down the Shift key as you click +.)

- ▶ Choose Live → New Cue (or press Command-Plus). A new cue is inserted below the selection, or at the end of the cuelist if no items are selected.
- ▶ Control-click anywhere in the cuelist and choose New Cue from the shortcut menu. A new cue is inserted below the clicked item.

When the cue has been added, the cue inspector appears to the right of the cuelist, showing the cue's contents and other options.

- 2 Type a name for the cue, then press Return.
- 3 Drag presets and sequences from the Preset Palette to the upper part of the cue inspector.
- 4 Edit the cue's other properties in the inspector, as described in [Edit cue contents and options](#) later in this chapter.

### Create a cue from one or more presets and sequences

- ▶ Select one or more presets and/or sequences in the Preset Palette and drag them to a blank part of the cuelist or in between two rows.

Lightkey creates a new cue which contains the dragged objects.

### Create multiple cues from presets and sequences

- 1 Select several presets and/or sequences in the Preset Palette.
- 2 Drag the presets or sequences to a blank part of the cuelist or in between two rows. Hold down the Command key when the pointer is over the cuelist.

Lightkey creates a new cue for each dragged object, containing just this object.

## Cue groups

For a better overview you can organize your cues in groups which can be collapsed and expanded as necessary. Whether a group is expanded or not has no effect on playback order. Groups can also contain other groups.

### Create an empty cue group

- 1 Do one of the following:
  - ▶ Choose Live → New Group (or press Command-Shift-Plus). A new group is inserted below the selection, or at the end of the cuelist if no items are selected.

- ▶ Control-click anywhere in the cuelist and choose New Group from the shortcut menu. A new group is inserted below the clicked item.

2 Enter a name for the group and then press Return.

### Create a cue group from existing items

1 Select some items in the cuelist. (Hold down the Shift or Command key to select multiple items.)

2 Do one of the following:

- ▶ Choose Live → New Group From Selection (or press Command-Shift-Option-Plus).
- ▶ Control-click one of the items and choose New Group From Selection from the shortcut menu.

3 Enter a name for the group and then press Return.

### Expand or collapse a cue group

- ▶ Click the disclosure triangle to the left of the group name.

### Cuelist timing

Each cue in a cuelist can have a **hold time** after which it is deactivated and the next cue is activated (possibly with a crossfade) when the cuelist runs. Alternatively you can click » or press the Space bar to manually go to the next cue.

In addition, each cue has a **fade time** which determines the duration of the crossfade to the next cue. If the fade time is zero then the next cue becomes active instantly. Alternatively you can drag the Xfade slider to manually control the crossfade duration.

▶ **Important:** Fade times do not apply to smart lights. They use a fixed fade time which can't be changed in Lightkey.

**Example:** Cue 1 has a hold time. Cue 2 has no hold time and remains active until » is pressed.

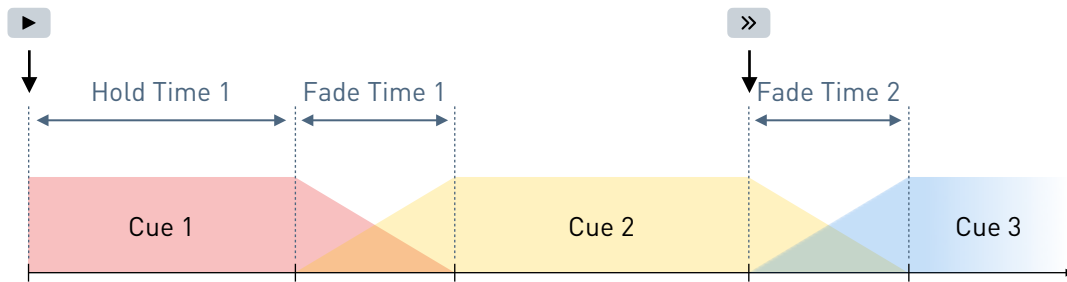

If a cue contains one or more sequences with a fixed loop count, Lightkey will automatically proceed to the next cue in the cuelist when all sequences have finished (even if the cue has no hold time or if the hold time has not yet elapsed).

### Change a cue's hold or fade time

- 1 Select one or more cues. (Hold down the Command or Shift key as you click to select multiple cues. By selecting multiple cues you can change their hold or fade times at once.)
- 2 Click in the Hold Time or Fade Time column and type a new value. You can also use the following keyboard shortcuts:
  - ▶ Up/Down Arrow: Increase/decrease the time by one second.
  - ▶ Option-Up/Down Arrow: Increase/decrease the time by 0.1 seconds.
  - ▶ Shift-Up/Down Arrow: Increase/decrease the time by 10 seconds.

Leave the hold time field empty if you want to advance to the next cue manually.

- 3 Press Return to end editing.

★ **Tip:** When editing hold or fade times, press Tab or Shift-Tab to quickly jump to the next or previous field.

You can also change hold and fade times in the Timing section of the cue inspector. See [Edit cue timing options](#) later in this chapter.

The crossfade between cues is also affected by the **fade curve** which appears to the left of the fade time. For details, see [Fade curves](#) later in this chapter.



## Select cues for playback

Sometimes you may want to skip a cue when the cuelist runs. For example, you may want to retain two versions of a cue but only use one of them in the show.

### Skip or unskip a cue

- ▶ Click the checkbox to the left of the cue name.  
If the checkbox is off, the cue will be skipped.

## Organize cues

Here are ways to organize cues in a cuelist.

### Move a cue or group

- ▶ Drag the item up or down in the cuelist.

### Reorder multiple cues or groups

- 1 Select the items in the cuelist. Hold down the Shift or Command key to select multiple items.
- 2 Drag the selected items to the desired position.

### Rename a cue or group

- 1 Click the item in the cuelist to select it.
- 2 Do one of the following:
  - ▶ Click the item's name.
  - ▶ Choose Edit → Rename (or press Return).
  - ▶ Control-click the item and choose Rename from the shortcut menu.
- 3 Enter a new name and then press Return.

### Renumber cues

- 1 Rename the first of the cues that you would like to renumber and add a number before its name, for example, "010 My cue". This determines where the cue numbers begin.
- 2 Select all cues that you would like to renumber, including the cue you just changed.

### 3 Do one of the following:

- ▶ Choose Live → Renumber.
- ▶ Control-click one of the cues and choose Renumber from the shortcut menu.

Lightkey adds increasing numbers before the names of the cues (or updates any existing numbers).

### Duplicate a single cue or group

- ▶ Hold down the Option key and click + next to an item in the cuelist.

Lightkey will create a copy of the item below the original.

### Duplicate multiple cues or groups

- 1 Select the items in the cuelist. (Hold down the Command or Shift key as you click to select multiple items.)
- 2 Do one of the following:
  - ▶ Choose Edit → Duplicate (or press Command-Shift-D).
  - ▶ Control-click one of the items and choose Duplicate from the shortcut menu.

Lightkey will create a copy of the items below the original items.

### Duplicate cues or groups by dragging

- 1 Select the items in the cuelist. Hold down the Command or Shift key and click to select multiple items.
- 2 Hold down the Option key and drag the items up or down.

Lightkey will add copies of the items at the target location.

### Delete a single cue or group

- ▶ Click — next to an item in the cuelist.

### Delete multiple cues or groups

- 1 Select the items in the cuelist. (Hold down the Command or Shift key as you click to select multiple items.)

2 Do one of the following:

- ▶ Choose Edit → Delete.
- ▶ Control-click one of the items and choose Delete from the shortcut menu.
- ▶ Press Delete.

If you accidentally deleted an item, choose Edit → Undo Delete.

## Copy and paste cues

You can copy cues and entire cue groups to the Clipboard and paste them again later. You can also copy and paste cues between different Live view pages.

### Cut or copy a cue or group

Do one of the following:

- ▶ Select the items in the cuelist and choose Edit → Cut or Edit → Copy (or press Command-X or Command-C).
- ▶ Control-click a cue or group and choose Cut or Copy from the shortcut menu.

### Paste cues from the Clipboard

Do one of the following:

- ▶ Choose Edit → Paste (or press Command-V).
- ▶ Control-click anywhere in the cuelist and choose Paste from the shortcut menu.

## Filter cuelist items

To quickly find an item you can filter the cuelist so only items whose name contains the search text are shown.

### Filter items in a cuelist

1 Do one of the following:

- ▶ Click **Q** in the toolbar.
- ▶ Choose Edit → Find... (or press Command-Option-F).

A search field appears near the right end of the toolbar.

2 Click the **Q** symbol in the search field and choose Cuelist from the menu.

- 3 Enter the text to search for in the search field. As you type the cuelist is filtered accordingly.
- 4 To remove the filter click  in the search field.

## Edit cue contents and options

You can edit the contents and other options for cues in the cue inspector which appears on the right of the Live view. This applies to both cues associated with a button and cues in a cuelist.

### Inspect a cue with a button

Do one of the following:

- ▶ Hold down the Command key and click the button.
- ▶ Control-click a button and choose Get Info from the shortcut menu.
- ▶ In edit mode, select one or more buttons and choose Live → Get Info (or press Command-I).
- ▶ In edit mode, double-click a button.
- ▶ Force click a button (requires a trackpad with Force Touch support).

### Inspect a cue in a cuelist

Do one of the following:

- ▶ Select one or more cues and choose Live → Get Info (or press Command-I).
- ▶ Hold down the Command key and click the cue's name.
- ▶ Control-click a cue and choose Get Info from the shortcut menu.
- ▶ Force click a cue (requires a trackpad with Force Touch support).

## Edit cue contents

You can easily change the presets and sequences in a cue by drag and drop.

### Edit a cue's contents

- 1 Make sure that only a single cue is selected. (You cannot edit the contents of multiple cues.) The contents are shown in the upper part of the cue inspector.

## 2 Edit the cue's contents:

- ▶ To add a preset or sequence to the cue, drag it from the Preset Palette to the upper part of the cue inspector.
- ▶ To remove a preset or sequence from the cue, click the object in the cue inspector and press Delete. Alternatively, place the pointer over the object and swipe left, then click Remove.
- ▶ To show the fixture properties defined by a preset or sequence, select it in the cue inspector. Lightkey will display the names of the defined properties next to the fixture icons in the Preview.
- ▶ To edit a preset in a cue, move the pointer over the preset in the cue inspector and click Edit, or double-click the preset. See [Edit a preset](#) in chapter 9, [Presets and sequences](#).
- ▶ To reveal a preset or sequence in the Preset Palette, Control-click the object in the cue inspector and choose Show in Palette from the shortcut menu.

### Add a preset or sequence to several cues

- 1 Select multiple cue buttons or cues in a cuelist.
- 2 Drag a preset or sequence from the Preset Palette to the upper part of the cue inspector.

The preset or sequence is added to all selected cues.

### Quickly add presets or sequences to a cue

- ▶ Drag one or more presets or sequences from the Preset Palette to a button in the Live view or to a cue in a cuelist.

The items in the Preset Palette are often organized in groups. Lightkey can show the names of the top-level enclosing group in the cue inspector for a better overview.

### Change whether the cue inspector shows group names

- 1 Choose Lightkey → Settings... (or press Command-Comma) and then click General.
- 2 Click "Show top-level preset groups in cue inspector".

Often all presets in a group define the same set of properties for the same set of fixtures. For example, each preset in a group might select a different gobo for a set of moving lights. It wouldn't make sense to add more than one of these presets to the same cue, and Lightkey can help you prevent this.

### **Mark presets as mutually exclusive**

- 1 Do one of the following:
  - ▶ Double-click a group in the Preset Palette.
  - ▶ Control-click a preset group and choose Get Info from the shortcut menu.
- 2 In the window that appears, select "Presets are mutually exclusive".

If you add a preset from a group of mutually exclusive presets to a cue, Lightkey will remove any other presets in that group from the cue. Enabling this option does not change the contents of existing cues.

### **View cue contents**

Lightkey can give you a quick overview of the fixtures and fixture properties affected by a cue.

### **Show the contents of a cue**

Do one of the following:

- ▶ Hold down the Command and Option keys and click a button in the Live view or a cue's name in a cuelist.
- ▶ Control-click a button in the Live view or a cue in a cuelist and choose Show Properties from the shortcut menu.
- ▶ Select a button in the Live view (this assumes that the Live view is in edit mode) or a cue in a cuelist, then choose Live → Show Properties.

Lightkey will display the names of the properties defined for each fixture next to the fixture icons in the Preview.

### **Hide the contents of a cue**

Do one of the following:

- ▶ Click anywhere in the Preview.

- ▶ Press Esc, Return, or Enter.

## Edit ad hoc properties

Apart from presets and sequences from the Preset Palette, a cue can also contain fixture properties that have been overridden when the cue was created. These appear in the cue inspector as a special preset called “Ad hoc properties”. You can edit a cue’s ad hoc properties after the cue has been created.

### Edit the ad hoc properties in a cue

- 1 Do one of the following:
  - ▶ Control-click a button in the Live view or a cue in a cuelist and choose Edit Ad Hoc Properties from the shortcut menu.
  - ▶ Select a button in the Live view (this assumes that the Live view is in edit mode) or a cue in a cuelist, then choose Live → Edit Ad Hoc Properties.

An item which represents the ad hoc properties is added to the Preset Palette while the properties are being edited.

- 2 Make changes to the fixture properties. (See chapter 8, [Fixture properties](#), for more information.)
- 3 Click Update next to the “Ad hoc properties” item in the Preset Palette or in the toolbar (or press Return). (To discard your changes and return to the preset’s previous state, hold down the Option key and click Cancel or choose Preset → Cancel Editing).

After editing, the item for the ad hoc properties disappears again from the Preset Palette.

Alternatively you can merge the currently overridden fixture properties into the ad hoc properties of one or more cues. This technique is especially useful when you want to change the ad hoc properties of multiple cues at once.

### Add the overridden fixture properties to one or more cues

- 1 Select one or more fixtures and change their properties. (See chapter 8, [Fixture properties](#), for more information.) Fixtures with overridden properties display a blue dot to the left to their name in the Preview.
- 2 Do one of the following:

- ▶ Control-click a button in the Live view or a cue in a cuelist and choose Add Overrides from the shortcut menu.
- ▶ Select one or more buttons in the Live view (this assumes that the Live view is in edit mode) or one or more cues in a cuelist, then choose Live → Add Overrides.
- ▶ To add the overridden properties for the selected fixtures only, hold down the Option key as you perform one of the preceding steps. The command changes to Add Overrides for Selected Fixtures.

## Edit cue timing options

The Timing section of the cue inspector lets you change a cue's timing options.

Cue buttons have a fade-in and fade-out time which apply when the cue becomes active or inactive, respectively. If a fade time is zero, the cue activates or deactivates instantly. Each fade time has a corresponding fade curve.

Cues in a cuelist have a hold time (which is optional) and fade time to the following cue. See [Cuelist timing](#) earlier in this chapter for more information. Cues also have a fade curve for the crossfade to the next cue.

▶ **Important:** Fade times do not apply to smart lights. They use a fixed fade time which can't be changed in Lightkey.

## Change a cue's timing options

- 1 Open a cue's inspector (as described earlier in this section) and scroll to Timing.
- 2 Change the settings as appropriate:
  - For cue buttons, change the fade-in and fade-out time and the corresponding fade curves.
  - For cues in a cuelist, change the hold time, fade time, and fade curve.

Editing fade curves is described in [Fade curves](#) later in this chapter.

If you're using a cuelist, you can also change hold and fade times directly in the list. See [Cuelist timing](#) earlier in this chapter.



You can set the initial hold time, fade times, and fade curves for new cues in the Timing pane of Lightkey's Settings window. You can also increase the precision (number of decimal places shown) for hold and fade times.

### Change the hold and fade times for newly created cues

- 1 Choose Lightkey → Settings... (or press Command-Comma) and click Timing.
- 2 Change the values in the fields for the cue hold and fade time. (To revert a value to the standard value, delete the field contents and press Return.)

### Change the precision for hold and fade times

- 1 Choose Lightkey → Settings... (or press Command-Comma) and click Timing.
- 2 Select an option from the "Time precision" pop-up menu.

## Edit button appearance and behavior

There are different types of cue buttons which are described earlier in this chapter. This section doesn't apply to cuelists.

### Change button options

- 1 Open the inspector for a button in the Live view and scroll to Button.
- 2 Change the settings as appropriate:
  - **Button Type:** Changes the button's type, as described at the beginning of this chapter.
  - **Behavior** (push buttons): Allows you to choose how a push button activates its cue. There are two options:
    - **Toggle:** Clicking the button once activates the cue, clicking it again deactivates the cue.
    - **Flash:** The cue is activated when you press the mouse button over the button and deactivated when you release the mouse.
  - **Controls** (faders): Determines which fixture properties are affected by the fader value. If you select All Properties (the default), dragging the fader affects all properties defined in the cue. If you select individual properties, like Dimmer, Color, or Iris, only those properties are affected by the fader's value.

- **Priority:** Controls the cue’s priority which is relevant if multiple cues define the same fixture properties. See [Output order of precedence](#) later in this chapter for more information.
- **Color:** Allows you to choose the color in which the button appears in the Live view. If you choose Automatic, Lightkey tries to find a color based on the cue’s contents.
- **Alignment:** Change the alignment of the button’s title.
- **Show Fonts:** Change the font of the button’s title. Only available in edit mode.
- **Activate at startup:** Lightkey can automatically activate one or more cue buttons in the selected Live view page when you open the application or a project. This way you can define a default state for your lights. (Note that this setting will be ignored if the option “Restore active cues, modifiers, and Master Dimmer” is selected in the Settings window. See [Startup state](#) later in this chapter.)
- **Activate before quitting:** Lightkey can also activate one or more cue buttons just before you quit the application or close the project. Their cues will be active for 0.5 seconds, which is useful for things like moving your moving lights to their home positions, etc.
- **Always active:** This option applies when a cue button is attached to other buttons. If selected, it ensures that one of the attached buttons is active at any time. This can be useful, for example, for a group of color selection buttons.

## Edit modifiers

A **modifier** is a parameter which alters the output of one or more cues in some way. You can quickly change modifier values in the Live view or with an external controller while you run your show.

You can add modifiers to a single cue or to a frame. Frame modifiers apply to all cues in the frame, similar to a “submaster”.

Modifiers are applied to the final output of the cue, whether it comes from fixture properties defined in the cue, sequences in the cue, fanning, or effects. For example, they can change the result of a movement or color effect while the effect is running. This makes modifiers a powerful way to change a cue’s look on the fly.

Some modifiers are multiplied with the value of a fixture property. Here's an example showing the results of the Dimmer modifier at 150%:

Fixture	Dimmer in cue	Dimmer output
FX1	50 %	75 %
FX2	40 %	60 %
FX3	100 %	100 %

Other modifiers are added to the value of a fixture property. The following example shows the results of the Pan Angle modifier at +30°:

Fixture	Pan angle in cue	Pan angle output
FX1	-120°	-90°
FX2	+50°	+80°
FX3	-90°	-60°

If a modifier is present in a button and its enclosing frame, both modifiers are applied to the output. For example, if a cue's Pan Angle modifier has a value of +50° and the enclosing frame's modifier has a value of -20° then the pan angles are shifted by +30°.

The following modifiers are available:

- **Speed:** Affects the speed of the cue. For example, setting the speed to 2.0x makes the cue run at twice the normal speed.

You can choose exactly which aspects of the cue are affected by the modifier. For example, you may want to control the speed of a movement effect but not the gobo rotation speed. See below for more information.

Setting the Speed modifier to 0 pauses the cue, and changing it to a positive value resumes seamlessly from where it left off.

- **Beat Multiplier:** Affects the timing of beat-controlled sequences and effects in the cue. For example, a multiplier of x2 makes them advance on every second beat.

The modifier is multiplied with the sequence's or effect's own beat multiplier. For example, if a cue contains a sequence whose beat multiplier is  $\div 2$ , and the cue's Beat Multiplier modifier is set to  $\times 6$ , then the resulting multiplier is  $\times 3$  (the sequence advances on every third beat). However, the resulting multiplier can never be smaller than  $\div 12$  or higher than  $\times 12$ .

- **Time Offset:** The modifier value is added to the Time Offset parameter of any chase pattern, curve, and movement effects in the cue.
- **Fade Time:** Extends or shortens a cue's fade times. For example, a modifier value of 200% doubles the fade time, and a value of 0% disables fading.
- **Dimmer:** The Dimmer values in the cue are multiplied by the modifier.
- **Hue:** Applies to fixtures with RGB or CMY color mixing. The modifier value (between  $0^\circ$  and  $360^\circ$ ) is added to the hue values in the cue.
- **Color Temperature:** The modifier value (between  $-5000\text{K}$  and  $+5000\text{K}$ ) is added to the color temperatures in the cue.
- **Green Saturation:** The modifier value (between  $-100\%$  and  $+100\%$ ) is added to the green saturation values in the cue.
- **Xfade to Color:** The xfade to color values in the cue are multiplied by the modifier.
- **Pan Angle, Tilt Angle:** The modifier values (between  $-180^\circ$  and  $+180^\circ$ ) are added to the pan and tilt angles defined in the cue.
- **Focus:** The focus values in the cue are multiplied by the modifier.
- **Zoom Angle:** The zoom angles in the cue are multiplied by the modifier.
- **Iris Size:** The iris sizes in the cue are multiplied by the modifier.
- **Frost Amount:** The frost amounts in the cue are multiplied by the modifier.
- **Fog Amount:** The fog amounts in the cue are multiplied by the modifier.

You can choose which aspects of the cue are affected by the Speed modifier:

- **Sequence Speed:** Affects the speed of any sequences in the cue with manual timing.
- **Effect Speed:** Affects the speed of any effects in the cue with manual timing.
- **Rainbow Speed:** Affects the speed of any rainbow effects (color wheel rotation).
- **Vector Speed:** Affects the speed of pan/tilt movements in vector mode.

- **Infinite Pan/Tilt Speed:** Affects the speed of any infinite pan or tilt movement.
- **Gobo Rotation Speed:** Affects the gobo rotation speed.
- **Gobo Shake Speed:** Affects the gobo shake speed.
- **Gobo Change Speed:** Affects the gobo change speed (gobo wheel rotation).
- **Strobe Speed:** Affects the speed of strobe effects.
- **Shutter Pulse Speed:** Affects the speed of shutter pulse effects.
- **Prism Rotation Speed:** Affects the prism rotation speed.

### Select which modifiers are visible in the Live view

- 1 Open the inspector for a cue or frame (as described earlier in this section) and scroll to Modifiers.
- 2 Select the modifiers you would like to control. If you selected a cue, only modifiers which apply to the cue are enabled (for example, Pan Angle is only available if the cue defines the Position property for at least one fixture).
- 3 To select which aspects are affected by the Speed modifier, click Options and choose items from the menu. If you selected a cue, only options which apply to the cue are enabled (for example, Gobo Rotation Speed is only available if at least one fixture in the cue has a rotating gobo).

You can set default values for modifiers which will be applied at startup. To use default values, make sure the option “Restore active cues, modifiers, and Master Dimmer” is not selected in the Settings window. See [Startup state](#) later in this chapter.

### Change the default value for a modifier

- 1 Exit edit mode, if necessary.
- 2 Press the mouse button over a modifier’s icon and drag up or down to set the modifier’s value.
- 3 Control-click the modifier and choose Set as Default from the shortcut menu.

## Fade curves

Lightkey gives you fine-grained control over the way cues fade in, out, or crossfade. You can choose one of the built-in fade curves or create your own, including individual curves for selected fixture properties and fixtures. This section also applies to sequence steps.

A **fade** determines how fixture properties change over time between two states—e.g. when you activate or deactivate a cue, or switch between two cues, sequence steps, or Live view pages (crossfade). The time between the two end states is called the **fade time**. If the fade time is zero, fixture properties change instantly and the fade curve has no effect.

A **fade curve** determines the value of fadeable fixture properties like Dimmer or Pan and Tilt during the fade. For a fade-in or crossfade, the curve starts at 0% (cue is off resp. first cue is on) and ends at 100% (cue is fully on resp. second cue is on). For a fade-out, the curve starts at 100% (fully on) and ends at 0% (fully off). The default fade curve is simply a line between those values (linear fade).

Fixture properties with discrete (non-fadeable) values, like Color Wheel or Shutter, change when the fade curve crosses 50%.

❖ **Note:** When you switch between attached buttons, Lightkey performs a crossfade between the cues. This creates a smoother transition than fading the cues out and in independently. For best results, attached buttons should have identical fade times and curves, and the fade-out curve should match the (inverted) fade-in curve.

➤ **Important:** Fade curves do not apply to smart lights. They use a predefined fading behavior which can't be changed in Lightkey.

Fade curves also do not apply to manual fades with the Xfade slider.

### Edit a fade curve

- ▶ Click the curve icon to the left of the fade time for a cue (in the cue inspector or a cuelist) or sequence step (in the sequence inspector or Preset Palette).

To edit the fade curve for a sequence step, the step must have an individual fade time. Otherwise the sequence's default fade time and curve will be used.

The fade curve appears.

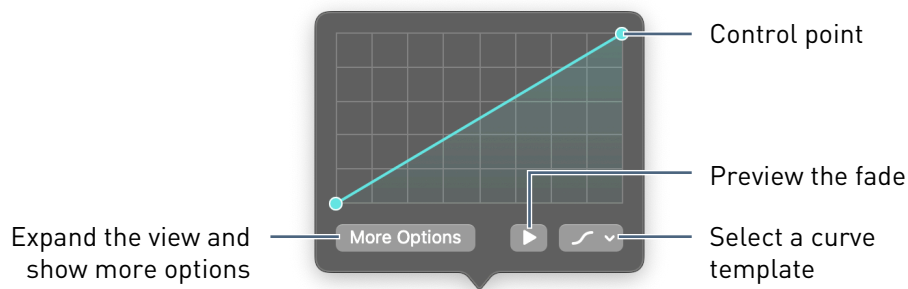

### Choose a curve template

- ▶ Click  and select a fade curve from the menu.

### Preview the fade

- ▶ Click . (This feature is not available for sequences.)

A curve is defined by a set of **control points**. The curve segments between the points can be either straight or curved.

### Select control points

- ▶ To select a single point, click the point.
- ▶ To select multiple points, press the mouse button over a blank part of the curve area and drag across the points.
- ▶ To toggle a point's selection state, hold down the Command key and click the point.
- ▶ To select a range of points, click the first point, then hold down the Shift key and click the last point in the range.
- ▶ To select all points, choose Edit → Select All (or press Command-A).
- ▶ To clear the selection, choose Edit → Deselect All (or press Command-Shift-A or Esc) or click a black part of the curve area.
- ▶ To select the points one by one from left to right, press Control-Tab. To select from right to left, press Control-Shift-Tab.

### Move control points

- ▶ Drag a point to move it. You can select multiple points to move them at once.

As you drag, Lightkey shows alignment guides that help with precise positioning, and snaps to gridlines and other points.

- ▶ To disable alignment guides and snapping, hold down the Control key as you drag.
- ▶ To constrain the motion to horizontal or vertical, hold down the Shift key as you drag.
- ▶ To move points in small steps, select one or more points and press one of the arrow keys. To move the points in larger steps, hold down the Shift key while pressing an arrow key.

### **Add or remove control points**

- ▶ To add a point, move the pointer over the curve and click the transparent handle which appears between two points.
- ▶ To add a point under the mouse, move the pointer over the curve, hold down the Option key, and then click.
- ▶ To remove one or more points, select them and press the Delete key. You can also Control-click a point and choose Delete from the shortcut menu.

### **Make a segment straight and curved**

- ▶ To toggle a curve segment between a straight line and a curve, move the pointer over the segment and double-click. You can also Control-click the segment and choose Straight or Curved from the shortcut menu.
- ▶ Double-click a control point to toggle the adjacent curve segments between straight lines and curves.

### **Transform control points**

- 1 Select three or more—but not all—control points. (You can't transform the entire curve because the endpoints must remain fixed.)
- 2 Control-click and choose Transform Points from the shortcut menu (or press T).

A blue outline with handles appears around the control points.

- 3 To scale the points:
  - ▶ Drag one of the four handles at the edges of the blue outline to scale the points along the horizontal or vertical axis.



- ▶ Hold down the Option key as you drag to scale from the center.
- ▶ To disable alignment guides and snapping, hold down the Control key as you drag.

To move the points:

- ▶ Place the pointer over the blue outline and drag.

4 Click outside the blue outline or press Return or Esc to exit transform mode.

### Copy and paste a curve

- 1 While editing a fade curve, choose Edit → Copy (or press Command-C).
- 2 Edit the fade curve of another cue or sequence step.
- 3 Choose Edit → Paste (or press Command-V).

Apart from the built-in curve templates Lightkey lets you create your own. Fade curve templates are part of the project.

### Save the current curve as a template

- ▶ Click  and choose Save as Template.

### Remove a curve template

- 1 Click  and choose Remove Templates...
- 2 In the dialog that appears, click one or more curves to select them, then click Remove.

Click More Options to expand the view and reveal options for multiple fade curves.

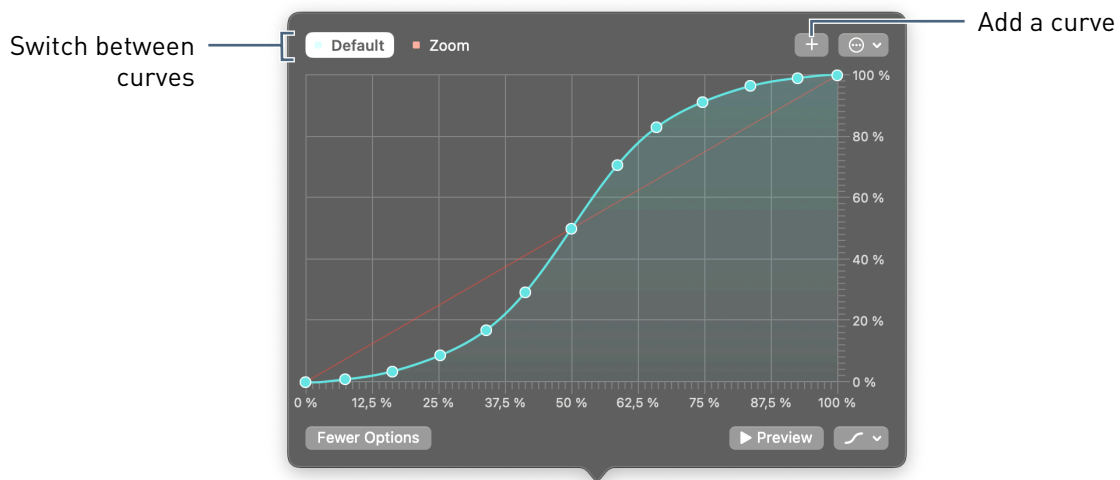

You can define special fade curves for selected fixture properties or fixtures. For example, you may want the Zoom property to change instantly while other properties gradually fade in. Multiple fade curves let you compose sophisticated transitions where sets of fixtures fade in one after the other. You can also use them for move-in-black behavior where moving lights remain blacked out until they moved to their positions.

Special fade curves can also apply to fixture properties which are not fadeable, such as Gobo Wheel or Shutter. These properties are still affected by fade curves because they change when the curve crosses 50%. For example, you may want the gobo to change at the start or end of the fade.

### Add a special fade curve

- 1 Click +.
- 2 In the dialog that appears, select one or more fixture properties or fixtures to which the special curve should apply.
- 3 Click OK.

A new fade curve is added which applies to the selected properties or fixtures only. All other fixture properties or fixtures use the default fade curve.

- 4 Edit the curve as previously described.

### Edit the criteria for a special fade curve

- 1 Click the name of a special fade curve to select it.
- 2 Click ⋮ and choose Edit (curve name)... from the menu.
- 3 Change the curve's criteria as desired, then click OK.

### Remove a special fade curve

- 1 Click the name of a special fade curve to select it. (You can't remove the default curve.)
- 2 Click ⋮ and choose Remove (curve name) from the menu.

Here are some examples for what you can do with special fade curves:

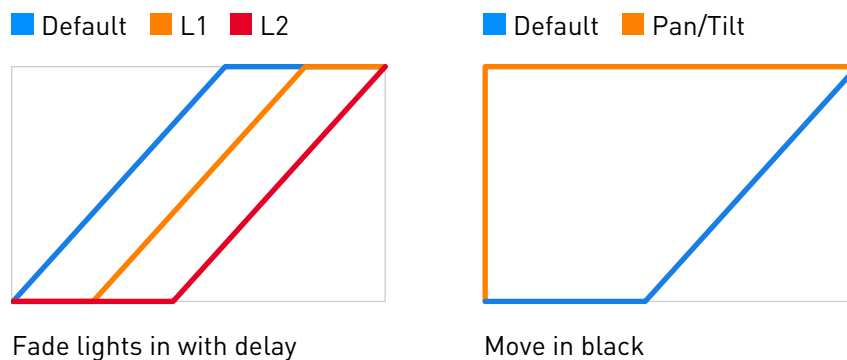

### Configure the axes

- ▶ Click the labels below the curve to toggle between percent and time. You can also Control-click the labels and choose Percent or Time from the shortcut menu.
- ▶ To change the number of subdivisions for percent values on the horizontal or vertical axis, Control-click the labels and choose Subdivisions from the shortcut menu, then select the desired number.

You can change the default fade curves for new cues and sequences. These settings are independent of the project, so you can only choose from the built-in curves. Changing the default fade curve does not affect existing cues and sequences.

You can also change the fade curve for transitions between Live view pages. The same curve is used for all Live view pages.

## Change default fade curves

- 1 Choose Lightkey → Settings... (or press Command-Comma) and click Timing.
- 2 Click one of the curve icons next to a fade time and select a built-in curve from the menu.

## Live control with cue buttons

This section describes how you use the Live view during a show to activate cues, change their intensity, and change modifiers. Note that active presets and overridden fixture properties take precedence over the Live view. You may want to deselect all presets, or even hide the Preset Palette, and clear the overridden properties before you start a show. The following tasks assume that the Live view is not in edit mode.

❖ **Note:** All actions in this section can also be performed through external hardware, such as a MIDI controller, or through custom keyboard shortcuts. See chapter 16, [External control](#), for more information.

## Push buttons

Push buttons may use either “toggle” behavior or “flash” behavior.

### Activate or deactivate a cue with a push button and “toggle” behavior

- ▶ Click the button.

### Activate a cue with a push button and “flash” behavior

- ▶ Press the mouse button over the button.

The cue is activated until you release the mouse.

Depending on the cue’s options, the cue will either (de-)activate instantly or fade (see [Edit cue options](#) earlier in this chapter). If a button is attached to other cue buttons, the other cues in the group will be deactivated. If the “Always active” option is enabled for a group, you cannot deactivate the active button in the group.

Cues normally remain active until you deactivate them, except for the following cases where Lightkey automatically deactivates cues:

- If you activate a button that is attached to other cue buttons, then the other buttons are automatically deactivated. (See [Attach buttons](#) earlier in this chapter for more information.)
- If a cue contains one or more sequences, it is automatically deactivated when all sequences have finished. (If at least one sequence repeats infinitely or has its “Freeze on completion” option selected, the sequence never finishes and the cue is not automatically deactivated.)

## Faders

Faders control to which degree (from 0% to 100%) a cue affects the output. By default, the fader’s state affects all properties defined by the cue, but you can confine it to specific properties like Dimmer or Iris. If a property can’t be faded (like Shutter or Gobo), its value changes when the fader crosses 50%.

### Change a cue’s intensity with a fader

- ▶ Drag the fader to 0% to deactivate the cue or to 100% to fully activate the cue. The fader values in between gradually change how much the cue affects the output.

## Step through buttons in a frame

If buttons are enclosed in a frame, you can step through them in sequential order using the arrow buttons in the upper right. The arrows can be shown or hidden in the frame inspector, as explained in [Frames](#) earlier in this chapter.

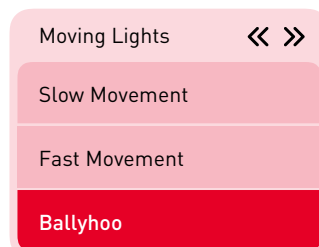

### Successively activate the buttons in a frame

- ▶ Click the arrows at the top-right of the frame to activate the previous or next button. The order is determined by the locations of the buttons.

## Change modifiers

Modifiers are a convenient and powerful way to alter the output of a cue during a show. They can be added to individual cues or an entire frame, in which case they affect all cues in the frame.



### Change the value of a modifier

- ▶ Press the mouse button over the modifier's icon, then drag the mouse up or down.
- ▶ Hold down the Shift key as you drag to change the modifier in coarse steps.
- ▶ To disable snapping to the neutral value, hold down the Control key.

Each modifier has a **neutral value** where it doesn't change the output of the cue, and a customizable **default value** which may be different from the neutral value. A small dot below the modifier icon indicates that the modifier has a non-neutral value and therefore affects the cue's result.

### Reset a modifier to its neutral or default value

- ▶ Control-click the modifier's icon and choose Reset to Neutral or Reset to Default from the shortcut menu.

## Continue effects across cues

When a cue contains effects, they normally start from the beginning when the cue becomes active. However, in some situations Lightkey can continue effects across multiple cue buttons. This works under the following conditions:

- Both cue buttons must be attached to each other.
- Both cues contain the same preset which defines the effect.
- If the effects are affected by modifiers, both cues have identical values for those modifiers.

## Live control with cuelists

This section describes how you run a light show from a cuelist. The cues are typically activated one by one in sequential order, although it's possible to skip to a random cue at any time. Whether groups are expanded or not doesn't affect the playback order. If the checkbox to the left of a cue's name is not selected, the cue is skipped.

❖ **Note:** The actions in this section can also be performed through external hardware, such as a MIDI controller, or through custom keyboard shortcuts. See chapter 16, [External control](#), for more information.

## Control playback

During playback, the name of the active cue is shown in the center of the toolbar.

### Start playback

- ▶ Click ▶.

Lightkey will activate the first cue in the cuelist. If the cue has a hold time, it will begin to run.

### Pause or resume playback

- ▶ Click ||. When playback is paused, the hold time of the current cue stops running. Pausing has no effect unless the current cue has a hold time.

### Activate the next cue

- ▶ Click » or press the Space bar.

Lightkey will activate the next cue (possibly with a crossfade). If there is no next cue, the current cue will be deactivated.

### Activate the previous cue

- ▶ Hold down the Shift key and click « or press Shift-Space.

### Stop playback

- ▶ Click ■.

Lightkey will deactivate all cues in the cuelist.

## Manual crossfading

Instead of setting fixed fade times for each cue, you can use the Xfade slider to perform manual crossfades. This gives you full control over the fade speed and is especially useful with a hardware controller. The Xfade slider can be shown or hidden in the cuelist inspector, as explained in [Cuelists](#) earlier in this chapter. You need to start playback before you can use the Xfade slider.

### Manually crossfade between cues

- ▶ Drag the Xfade slider from its current position to the opposite end.

This starts a crossfade from the current cue to the next, ignoring the cue's fade time. The crossfade ends when the slider has reached the opposite endpoint. If you move the slider all the way back to the original endpoint while the fade is in progress you can cancel the crossfade.

- ▶ Hold down the Shift key as you drag the Xfade slider to fade to the the previous cue instead.

After the crossfade has completed, move the Xfade slider in the opposite direction to begin the next crossfade.

▶ **Important:** Manual crossfading does not apply to smart lights. They use a fixed fade time which can't be changed in Lightkey.

## Activate arbitrary cues

Although cuelists are usually played back in their predefined order, you can skip to a random time when necessary.

### Jump to a specific cue instantly

Do one of the following:

- ▶ Control-click a cue and choose Activate from the shortcut menu.
- ▶ Double-click a cue.
- ▶ Select a cue and press Command-Return.



## Skip to a specific cue with a fade

Do one of the following:

- ▶ Control-click a cue and choose Activate With Fade from the shortcut menu. This fades to the cue according to the previous cue's fade time.
- ▶ Hold down the Option key and double-click a cue.
- ▶ Select a cue and press Command-Option-Return.

## Jump to a specific cue by name

- 1 Choose Live → Go to Cue... (or press Command-G).
- 2 Start typing the name of the desired cue. (If you use cue numbers, simply type the cue's number.)
- 3 When the completed name matches the cue that you want to select, click Go. (Hold down the Option key to enable crossfading.)

## Change modifiers

Modifiers are a convenient and powerful way to alter the output of a cue during a show.

### Change the value of a cue's modifier

- ▶ Press the mouse button over the modifier's icon to the right of the cue name, then drag the mouse up or down.
- ▶ Hold down the Shift key as you drag to change the modifier in coarse steps.
- ▶ To disable snapping to the neutral value, hold down the Control key.

Each modifier has a **neutral value** where it doesn't change the output of the cue, and a customizable **default value** which may be different from the neutral value. A small dot next to the modifier icon indicates that the modifier has a non-neutral value and therefore affects the cue's result.

### Reset a modifier to its neutral or default value

- ▶ Control-click the modifier's icon and choose Reset to Neutral or Reset to Default from the shortcut menu.

## Continue effects across cues

When a cue contains effects, they normally start from the beginning when the cue becomes active. However, in some situations Lightkey can continue effects across multiple cues in a cuelist. This works under the following conditions:

- Both cues are in the same cuelist.
- Both cues contain the same preset which defines the effect.
- If the effects are affected by modifiers, both cues have identical values for those modifiers.

## Blind mode

**Blind mode** allows you to make changes without affecting the DMX output. You can still see the results of your changes in the Preview. Once you exit blind mode, all changes are applied to the DMX output at once.

### Enter blind mode

- ▶ Click  in the toolbar or choose View → Blind Mode (or press Command-B).

While in blind mode, any active cuelists, sequences, and effects continue to run in the DMX output. You can make the following changes without affecting the DMX output:

- Activate/deactivate presets, sequences, and cues
- Change the overridden fixture properties
- Change a cue's intensity or modifiers
- Change the Master Dimmer

### Exit blind mode and apply your changes

- ▶ Click  in the toolbar or choose View → Blind Mode (or press Command-B).

### Exit blind mode and revert any changes you made

Do one of the following:

- ▶ Choose View → Cancel Blind Mode.
- ▶ Hold down the Option key and click  in the toolbar.

❖ **Note:** You can also enter or exit blind mode through external hardware, such as a MIDI controller, or through custom keyboard shortcuts. See chapter 16, [External control](#), for more information.

## Freeze output

When you freeze the output, Lightkey stops updating the DMX output and the Preview. This pauses any running cuelists, sequences, and effects.

### Freeze or unfreeze the output

- ▶ Click  in the toolbar or choose View → Freeze Output (or press Command-Period).

### Briefly freeze the output

- ▶ Press and hold the mouse button over the  button in the toolbar. Release the mouse button to unfreeze the output.

When you unfreeze the output, cuelists, sequences, and effects will continue to run seamlessly from where they left off.

❖ **Note:** You can also freeze or unfreeze the output through external hardware, such as a MIDI controller, or through custom keyboard shortcuts. See chapter 16, [External control](#), for more information.

## Startup state

By default, Lightkey presents the same default state each time you start the application or open a project:

- The first live page is selected.
- No presets, sequences, or cues are active except for the cues where the “Activate at startup” option is selected.
- Modifiers are at their default values.
- The Master Dimmer is at 100%.

This behavior is useful if you want to start with a “clean slate”, regardless of how the project was left after the last performance.

You can tell Lightkey to automatically activate one or more cue buttons at startup. This option is not available for cuelists.

### Automatically activate a cue at startup

- 1 Open the cue inspector and scroll to Button. (See [Edit button appearance and behavior](#) earlier in this chapter.)
- 2 Select “Activate at startup”.

Alternatively, you can tell Lightkey to remember the state before quitting or closing a project. This will restore the selected live page, active cues, modifier values, and Master Dimmer. In this case the “Activate at startup” option for cues is ignored.

### Restore the last state at startup

- 1 Choose Lightkey → Settings... (or press Command-Comma) and then click General.
- 2 Select “Restore active cues, modifiers, and Master Dimmer”.

★ **Tip:** To have Lightkey reopen the last project when you start the application, make sure that “Close windows when quitting an application” is turned off in the Desktop & Dock pane of System Settings.

## Output order of precedence

When a fixture property is defined at multiple points, the final output is determined in the following order:

1. Overridden fixture properties.
2. Selected presets and running sequences in the Preset Palette, in order of activation.
3. Cues in the Live view, ordered by descending priority. Priorities are evaluated as follows:
  - The priority of the enclosing frame, for cue buttons within a frame.

- The priority of the cue's button, for cues with a button.
- The priority of the cuelist, for cues in a cuelist.

If two cues have equal priority, the most recently activated cue takes precedence.

4. The default value of the fixture property.

You can change cue, frame, and cuelist priorities in the Live view inspector.

# Chapter 12

## Beat control

---

Lightkey lets you run light shows in sync with music. This chapter describes how to enable beat control for sequences and effects, and how to synchronize Lightkey to music.

Lightkey has a single, global source for the beat which usually matches the music that's playing. The beat source affects all sequences and effects that are marked as "beat-controlled". In other words, sequences and effects cannot use different beats, and the beat does not depend on the active sequences and effects.

In this context, the term **beat** or **beat grid** actually means two things:

- It defines the tempo, in beats per minute, to make effects and sequences run at the same speed as the music.
- It defines the phase synchronization, that is, when the beats occur, so effects and sequences are aligned with the music.

There are several ways to set the global beat grid. You can:

- "Tap" the beat by pressing the mouse button or a key four times. Lightkey will learn the beat and carry it forward at the same speed.
- Enter the exact beats per minute.
- Receive a MIDI Beat Clock signal sent by a DJ software, mixer, or audio analysis tool.

- Connect to other software through Ableton Link, a technology for synchronizing beat information between applications on the same computer or over a network.

## Beat-controlled sequences

You can easily turn a regular sequence into a beat-controlled one. A beat-controlled sequence advances to the next step in sync with the beat.

### Make a sequence beat-controlled

- 1 Double-click a sequence in the Preset Palette to open its inspector.
- 2 Click Timing and then select Beat-controlled.

When a sequence becomes beat-controlled, the Hold Time column changes to a Length column. By default each step has a length of 1 so the sequence advances on each beat. You can increase the steps' lengths or apply a beat multiplier to adjust the timing. For example, a multiplier of  $\div 2$  advances the sequence on every half beat, and a multiplier of  $\times 3$  advances it on every third beat. Additional parameters like quantum and offset give you even more control. For a thorough discussion see [Sequence timing](#) in chapter 9, [Presets and sequences](#).

## Beat-controlled effects

Some effects can be synchronized to the beat. This is true for pattern effects (some patterns only) and curve effects.

### Make an effect beat-controlled

- ▶ Edit the effect, then select the  icon in the Timing Mode options. If the icon isn't visible or is inactive then the effect can't be beat-controlled.

The exact behavior of beat-controlled effects is described in chapter 10, [Effects](#). Like with sequences, you can apply a beat multiplier to adjust the timing.

## Set the beat grid

There are various ways to set the beat grid—that is, define the tempo and alignment.

## By tapping

You can set the beat by pressing the mouse button or a key four times on each beat. Lightkey will “learn” the beat and carry it forward at the same speed.

### Tap the beat

- 1 Do one of the following:
  - ▶ Click the beat indicator at the bottom-left of the Live view.
  - ▶ Choose View → Set Beat (or press Shift-B).
- 2 Click Manual.
- 3 Press the mouse button or the Space bar four times on each beat.
- 4 Check if the animation in the beat indicator is in sync with the music. If not, repeat step 3.
- 5 Click the beat count at the bottom or press Return.

❖ **Note:** You can also tap the beat through external hardware, such as a MIDI controller, or through custom keyboard shortcuts. See chapter 16, [External control](#), for more information.

## As an exact value

You can manually specify the tempo (beats per minute). You can also align the beat grid while maintaining the current tempo.

### Set the tempo to an exact value

- 1 Do one of the following:
  - ▶ Click the beat indicator.
  - ▶ Choose View → Set Beat (or press Shift-B).
- 2 Click Manual.
- 3 Do one of the following:
  - ▶ Click the text field near the bottom, type a new value, and press Return. You can use fractional values, like “12.5”.



- ▶ Click the arrows next to the text field or press the Up/Down Arrow keys to increase or decrease the beats per minute. Hold down the Shift key as you click to change the value in intervals of 10.
  - ▶ Click ÷2 or ×2 to halve or double the current tempo.
- 4 Click the beat count at the bottom or press Return.

### Align the beat grid while maintaining tempo

- 1 Do one of the following:
  - ▶ Click the beat indicator.
  - ▶ Choose View → Set Beat (or press Shift-B).
- 2 Click Manual.
- 3 Do one of the following:
  - ▶ To synchronize the time of the next beat: Hold down the Option key and click once, or press Option-Space.
  - ▶ To synchronize the time of the downbeat: Hold down the Option and Shift keys and click once, or press Option-Shift-Space.
- 4 Click the beat count at the bottom or press Return.

❖ **Note:** You can also change the tempo or align the beat through external hardware, such as a MIDI controller. See chapter 16, [External control](#), for more information.

### Through MIDI Beat Clock

You can synchronize the beat with other software or external hardware which sends MIDI Beat Clock signals. MIDI (Musical Instrument Digital Interface) is a standard protocol that allows a wide variety of electronic music devices, control surfaces, and software to send and receive performance data. MIDI Beat Clock (or MIDI Clock) is a clock signal that is broadcast via MIDI to synchronize MIDI-enabled hardware and software.

You can synchronize the beat with the following kinds of software or hardware:

- DJ software like Traktor or DJ mixers which detect the beats per minute. This is usually the most accurate form of BPM detection because the software can determine the beat grid in advance.
- Audio analysis software such as Waveclock or Wavetick which analyzes audio as it plays. Lightkey itself does not perform audio analysis.

There are generally two ways to establish a connection between the source software or hardware and Lightkey:

- Some sources create a MIDI source port on which they send MIDI Clock signals. You select this port in Lightkey.
- Other sources require that you specify a MIDI destination port to which they send MIDI Clock signals. In this case Lightkey can create a MIDI destination port.

### Synchronize Lightkey to a MIDI Clock source

- 1 Do one of the following:
  - ▶ Click the beat indicator.
  - ▶ Choose View → Set Beat (or press Shift-B).
- 2 Click External.
- 3 Select an input source from the list.
  - ▶ If your MIDI source creates a MIDI output port, select it from the list.
  - ▶ If your MIDI source requires a destination port, select Lightkey MIDI Input. Lightkey creates a MIDI input port which you can select as destination in another software.

When MIDI Clock signals are received, the status changes to “Receiving”, and the animation in the beat indicator is in sync with the music.

- 4 Click the beat count at the bottom or press Return.

### Through Ableton Link

Ableton Link is a technology that synchronizes beat information over a wireless or wired network. It works with Ableton Live and a variety of other applications and devices. The source must be either on the same computer or on a computer on the same local network.

## Synchronize Lightkey via Ableton Link

- 1 Do one of the following:
  - ▶ Click the beat indicator.
  - ▶ Choose View → Set Beat (or press Shift-B).
- 2 Click External.
- 3 Click Ableton Link.

Lightkey looks for Ableton Link users on the same local network and displays the number of peers found. When a connected peer changes its beat grid, Lightkey's beat indicator adapts to the peer.

- 4 Click the beat count at the bottom or press Return.

## Examples

The following examples show you how to synchronize the beat with selected software through MIDI Beat Clock or Ableton Link.

❖ **Note:** This section is about third-party software from other manufacturers. We have carefully tested the integration with Lightkey at the time it was written, but cannot guarantee this functionality will work without errors and continue to work in the future.

## Ableton Live

Ableton Live is a music sequencer and digital audio workstation (DAW) software used by many musicians and DJs. This section shows how to synchronize Lightkey to Ableton Live through Ableton Link.

### Synchronize Lightkey with Ableton Live

- 1 Open Ableton Live and click Link at the upper-left of the main window to enable Link.

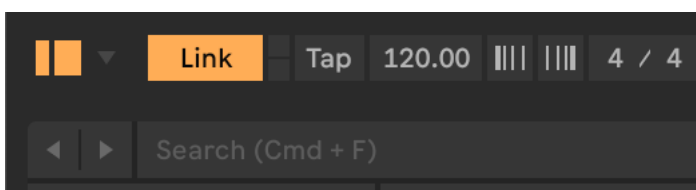

If you don't see the Link toggle, choose Live → Settings..., click Link, Tempo & MIDI, and make sure the button next to Show Link Toggle reads Show.

- 2 In Lightkey, click the beat indicator at the bottom-left of the Live view, then click External → Ableton Link.

When Lightkey finds Ableton Live, the status text reads "1 peer" and the beat indicator adapts to the tempo in Ableton Live.

## Logic Pro

Logic Pro is a music sequencer and digital audio workstation (DAW) software by Apple. This section shows how to synchronize Lightkey to Logic Pro through MIDI Clock.

### Synchronize Lightkey with Logic Pro

- 1 In Lightkey, click the beat indicator, then click External → Lightkey MIDI Input.
- 2 Open Logic Pro and choose Logic Pro X → Settings... → Synchronization.
- 3 Next to Transmit MIDI Clock, select one of the two destinations and choose Lightkey Input from the pop-up menu.

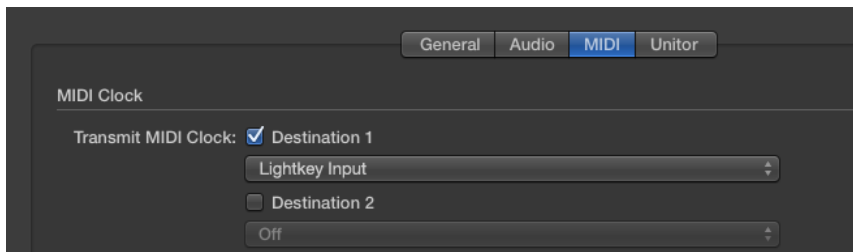

## MultiTracks Playback

Playback is a tracks player for worship services, available for iPad, iPhone, and Mac. This section shows how to synchronize Lightkey to Playback for iPad using MIDI Clock over Wi-Fi. For this, a MIDI network session is created in the app Audio MIDI Setup that comes with macOS. Your Mac and iPad must be connected to the same Wi-Fi network.

### Synchronize Lightkey with Playback

In Audio MIDI Setup:

- 1 Choose Window → Show MIDI Studio to open the MIDI Studio window.

- 2 Choose MIDI Studio → Open MIDI Network Setup... to open the MIDI Network Setup window.
- 3 Click + in the My Sessions section. This creates a session which your iPad can connect to. Make sure the checkbox to the left of the session is selected.
- 4 Select “Anyone” in the menu “Who may connect to me”.
- 5 Open the Playback app on your iPad. The iPad should now appear in the Sessions and Directories section in Audio MIDI Setup.
- 6 Select your iPad in the Sessions and Directories section, then click Connect. This adds your iPad to the session.

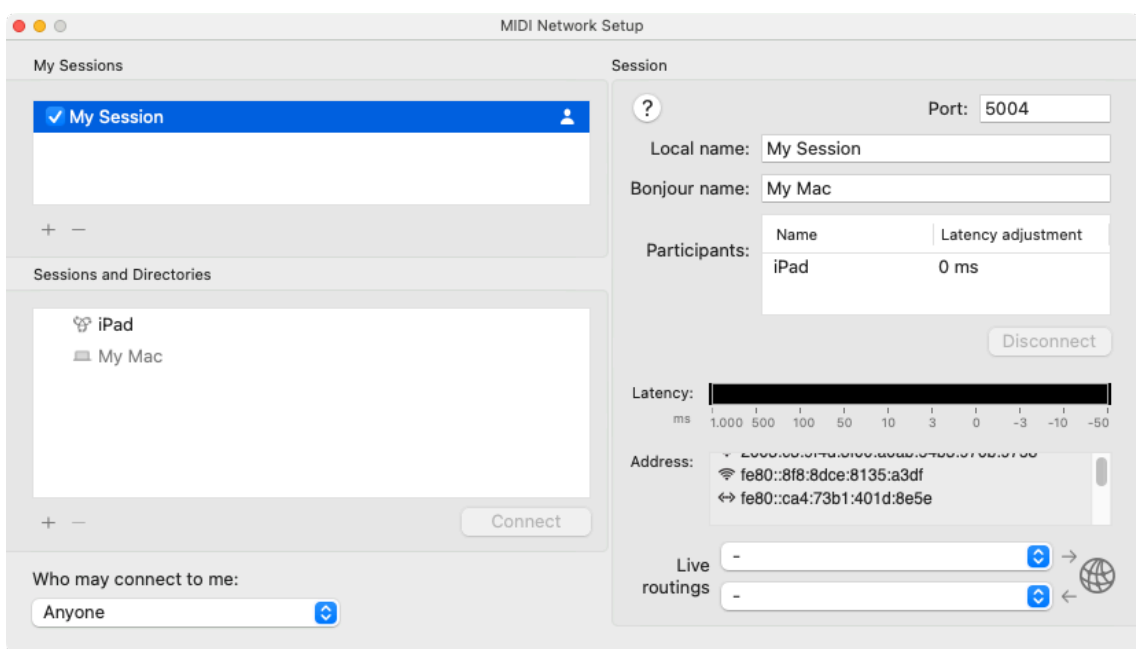

On your iPad:

- 1 Open the settings area in the Playback app.
- 2 Tap MIDI.
- 3 Next to MIDI Clock, tap Select Ports.
- 4 Select Network Session, then tap Done.

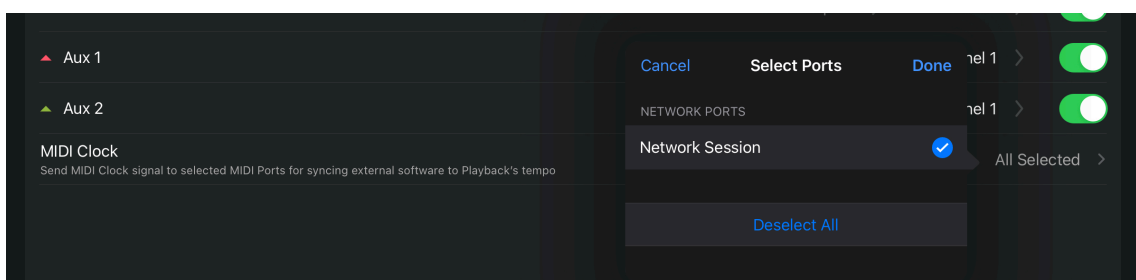

In Lightkey:

- 1 Click the beat indicator at the bottom-left of the Live view.
- 2 Click External and then select Network Session.

Once you start playback in the Playback app, the BPM display in Lightkey synchronizes to the music.

## Traktor

Traktor is a DJ software developed by Native Instruments. This section shows how to synchronize Lightkey to Traktor through MIDI Clock.

### Synchronize Lightkey with Traktor

- 1 Open Traktor, choose Traktor → Preferences..., and select Controller Manager on the left.
- 2 Create a new generic MIDI device. As Out-Port, select Traktor Virtual Output.



- 3 Click MIDI Clock on the left, then select Send MIDI Clock.

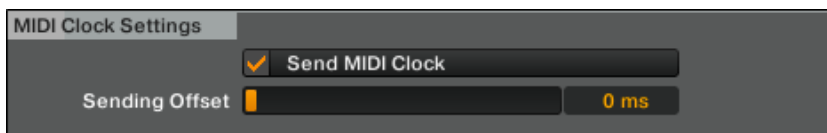

- 4 Open the Master Clock panel in Traktor's Global Section by clicking the metronome icon. (If you can't see the Master Clock / FX Panel, choose to Traktor → Preferences... → Global Settings and select Show Global Section.)
- 5 To start sending a MIDI Clock signal, click the Play/Pause button. The button appears blue when MIDI Clock is active.

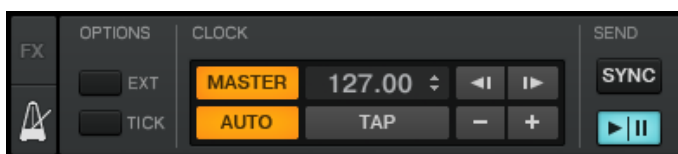

- 6 In Lightkey, click the beat indicator, click External, and choose Traktor Virtual Output.

## Waveclock

Waveclock by Wavesum is an audio analysis tool which converts music to MIDI Beat Clock signals in real time. You can use it if you play music through an app that does not perform beat detection (like iTunes or Spotify) or a CD deck. This section shows how to synchronize Lightkey to Waveclock through MIDI Clock.

### Synchronize Lightkey with Waveclock

- 1 In Lightkey, click the beat indicator, then click External, and choose Lightkey MIDI Input.
- 2 Open Waveclock. Choose Waveclock → Settings... and select Lightkey Input as output device. Close the Waveclock I/O Settings window.

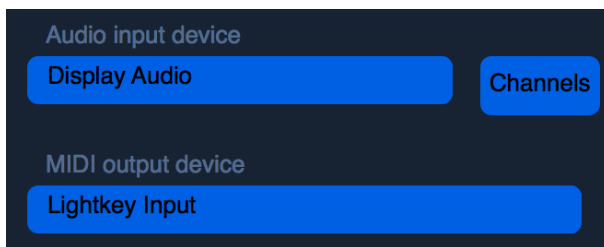

- 3 In the Waveclock window, select MIDI Clock.

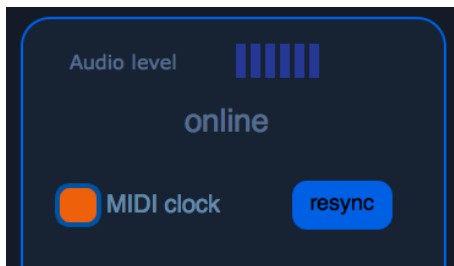

# Chapter 13

## Manage DMX fixtures

---

Before Lightkey can control your DMX lights you need to supply some basic information about the fixtures. This process is sometimes called “patching”.

DMX (Digital Multiplex) enables a controller—in this case, Lightkey—to control the features of a wide range of DMX-compatible devices or **fixtures**. They are connected to the controller through a DMX connection which consists of a series of DMX cables between the controller and the fixtures in the form of a “daisy chain” (that is, each fixture links to the previous and next fixture or the controller). DMX signals flow in one direction from the controller to the fixtures.

All fixtures on a single daisy chain form a **universe**. In many cases an installation will consist of only one universe, but depending on your license Lightkey can output DMX to up to 16 universes.

The fixtures on a universe are controlled by 512 **channels**, each of which can have a unitary value from 0 to 255 which controls a property of a fixture. Each fixture is assigned a consecutive range of channels: Simple fixtures like dimmers require only a single channel while some intelligent lights may require 20 or over 100 channels. The number of the first channel occupied by a fixture is called its **address**.

❖ **Note:** You can learn more about DMX universes and addresses in chapter 2, [Intro to DMX](#).



In order to know which fixture property is controlled by which channel, Lightkey needs a **fixture profile**. It contains a description of the fixture's capabilities and the way they are controlled. Lightkey comes with a built-in library of fixture profiles from a wide range of manufacturers and can import thousands of freely available profiles in the formats SSL2, FXT, and PFF. You can also create your own profiles using the built-in fixture editor.

In summary, in order to control a fixture you need to tell Lightkey its universe and address and provide a fixture profile. You manage this information in the **Fixture Manager**.

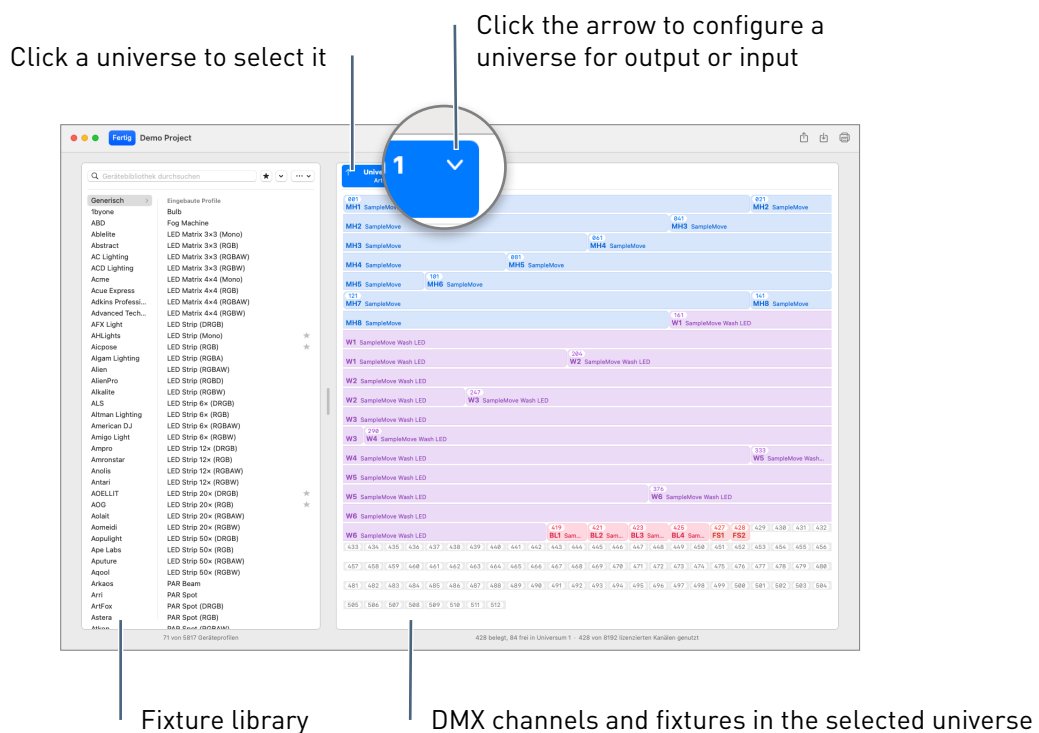

## Open the Fixture Manager

Do one of the following:

- ▶ Click  in the toolbar.
- ▶ Choose Lightkey → Manage Fixtures... (or press Command-Shift-Down Arrow).
- ▶ Click a fixture's short name in the Preview, then click the fixture's address (e.g. "Universe 1, channels 1 – 10") in the shortcut menu. This will open the Fixture Manager and show information about the clicked fixture.

## Close the Fixture Manager

Do one of the following:

- ▶ Click Done in the toolbar.
- ▶ Choose Lightkey → Manage Fixtures... (or press Command-Shift-Up Arrow).

On the left of the Fixture Manager is the fixture library which contains all built-in, imported, and user-created fixture profiles. The first column lists the manufacturers, the second column shows the profiles for the selected manufacturer. The library also contains a number of generic profiles which don't relate to a specific fixture model.

On the right is a grid representing the 512 channels in a DMX universe. Click a universe at the top to reveal its channels. For information on how to configure a universe for output or input, see [Configure universes](#) in chapter 14, [DMX output and input](#).

## Find the right fixture profile

Many simple fixtures work with one of the profiles in the Generic category of the built-in library. Double-click a profile to view a description of the profile. You can also find an [overview of the generic profiles](#) at the end of this User Guide.

The Generic category also includes a selection of flexible fixture profiles ("FLEX") for LED strips and matrixes. Flexible fixture profiles let you choose the desired number of LEDs when you patch the fixture.

For more complex lights you need a profile specific to the fixture. See [Find the right fixture profile](#) in chapter 4, [Set up your lights](#), to learn how to get fixture profiles. It's important to use a profile which exactly matches your fixture model, or the fixture will not work correctly. Profiles for other—even similar—lights will often not work.

## Filter the fixture library

You can apply filters to the fixture library to quickly find matching profiles for your lights.

- 1 Enter something in the search field above the fixture library to search for a manufacturer or model name.

- 2 Click ★ to view only fixture profiles that have been marked as favorites. (To mark a profile as favorite, Control-click the profile and choose Add to Favorites from the shortcut menu.)
- 3 Click the arrow to the right of the search field to reveal additional filter options.
  - ▶ Select a fixture type to only show fixtures of this type.
  - ▶ Use the Channels field to find fixture profiles with the specified number of channels. For example, enter “11, 15” to find profiles with both an 11 channel mode and a 15 channel mode.

Double-click a fixture profile in the library to view additional information.

## Add DMX fixtures

- 1 Select the universe which the new fixture is connected to.
  - 2 Drag a fixture profile from the library to the channel grid. The first occupied channel should match the fixture’s DMX address. Fixtures must not overlap.
- The fixture appears in the channel grid with a dashed outline. Below it you see a window with additional options.

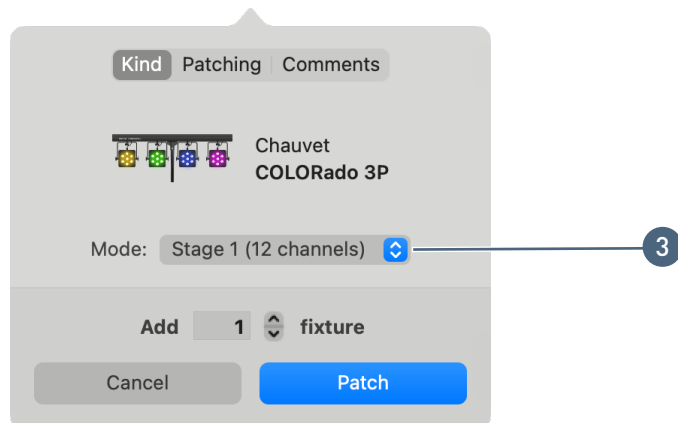

- 2 If the fixture has different operation modes (or “personalities”), select a mode from the pop-up menu below the fixture name. Be sure to select the same mode as on the fixture, or Lightkey will not be able to control the fixture. The mode determines how many channels the fixture occupies.

When patching a flexible LED strip or matrix, you can enter the desired number of LEDs here. The fixture will grow or shrink in the channel grid depending on the number of LEDs.

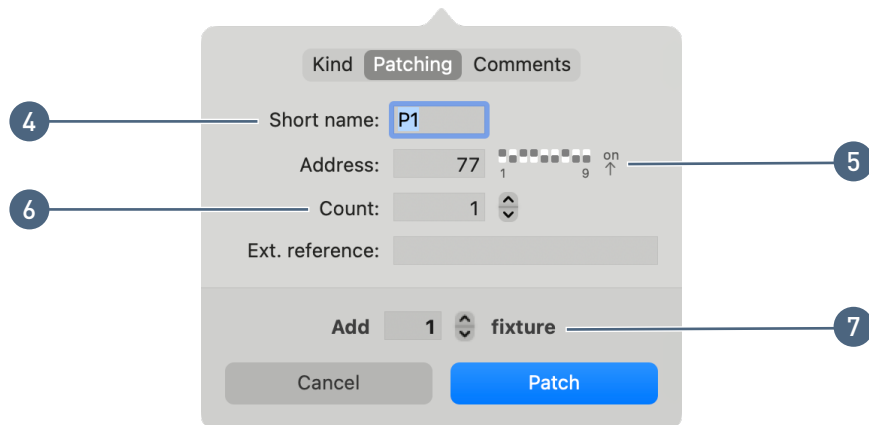

- 4 Assign a short name to the fixture. Short names appear in Lightkey’s Preview; they can be up to four characters long and typically include one or two letters and a number. If the short name ends with a number, you can increase/decrease it by pressing the Up/Down Arrow keys while the insertion point is in the field.

Lightkey proposes a short name based on the fixture type, but you should choose a naming scheme that’s suitable for your lighting installation. For example, if you have a row of PAR cans on the floor and one at the ceiling, you can name them F1, F2, F3, ... and C1, C2, C3, ...

- 5 If necessary, you can correct the fixture’s DMX address in the Address field. (You can increase/decrease the address by pressing the Up/Down Arrow keys while the insertion point is in the field.)
- 6 If the Count value is greater than one, Lightkey displays multiple instances of the fixture in the Preview which always share the same fixture properties. This is useful when you patch several identical fixtures to the same DMX address.
- 7 To patch multiple fixtures of the same type to consecutive DMX addresses, enter their number here. (You can increase/decrease the number by pressing the Up/Down Arrow keys while the insertion point is in the field.)

If the short name ends with a number, Lightkey automatically increments the number for each fixture. For example, if you add four moving heads and enter “MH6”, their names will be MH6 through MH9.

- 8 Click Patch (or press Return).

## Edit DMX fixtures

After patching your fixtures you can always come back and edit the information. This section pertains to DMX fixtures; for Hue fixtures see chapter 15, [Smart lights](#).

## View and edit DMX fixture information

You can change a fixture's address, short name, instance count, and other information without affecting your presets, sequences, and cues.

### View and edit information about a fixture

- 1 In the Fixture Manager, do one of the following:
  - ▶ Double-click a fixture in the channel grid.
  - ▶ Control-click a fixture in the channel grid and choose Get Info from the shortcut menu.
  - ▶ Force click a fixture in the channel grid (requires a trackpad with Force Touch support).
- 2 The following information is shown below the fixture:

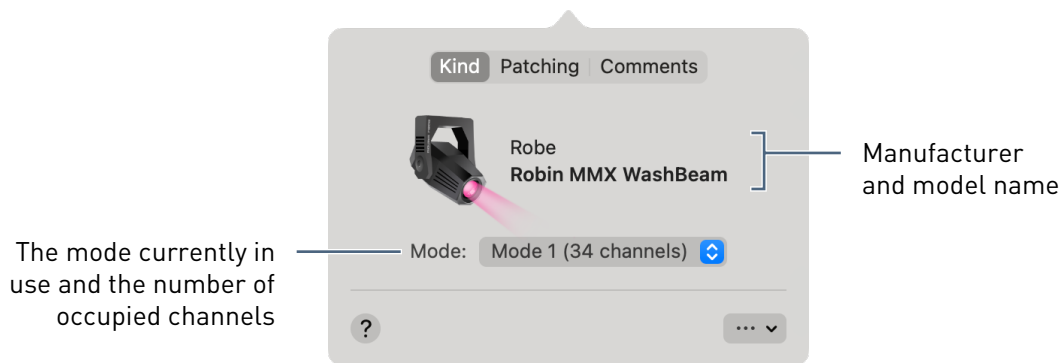

For flexible LED strips and matrixes you can also change the number of LEDs. It determines how many channels the fixture occupies.

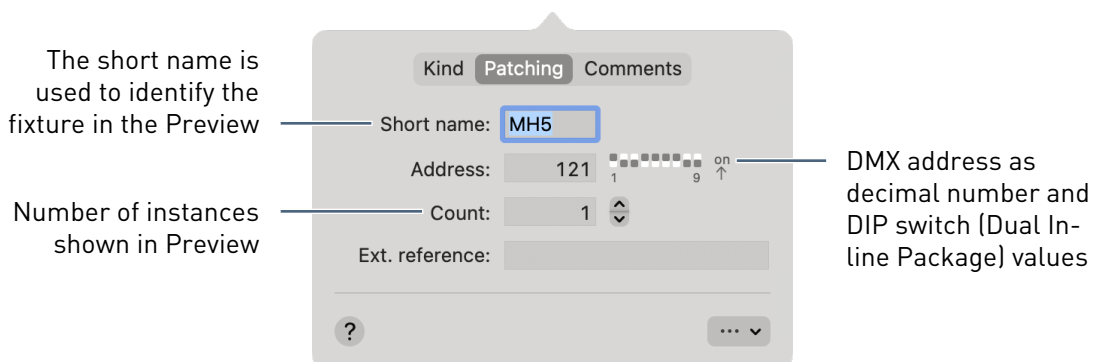

The External reference field can hold arbitrary text. It can be useful when interchanging patching information with another application through the import/export feature. The value of this field is not used by Lightkey.

Click Comments to attach a comment to the fixture. Comments also appear when you print or export fixtures.

## Edit information for multiple fixtures

- 1 Double-click a fixture in the channel grid.  
A window appears below the fixture.
- 2 Press the mouse button over a blank part of the window and drag it to a different location, detaching it from its fixture.
- 3 Hold down the Shift or Command key and click other fixtures in the channel grid to select them.
- 4 Change the information in the detached window. For example, select a different mode. This changes all selected fixtures.  
You can't change the address because it would not make sense to assign the same address to multiple fixtures.
- 5 Click **X** to close the detached window.

## Reveal one or more fixtures in the Preview

- 1 Select one or more fixtures in the channel grid. (Hold down the Command or Shift key as you click to select multiple fixtures.)
- 2 Control-click one of the fixtures and choose Show in Preview from the shortcut menu.

## Reveal a fixture's profile in the library

- ▶ Control-click a fixture in the channel grid and choose Show Profile in Library from the shortcut menu.

## Change a fixture's DMX address or universe

You can change a fixture's DMX address or universe at any time. All presets, sequences, and cues containing the fixture will continue to work.

## Change the DMX address of one or more fixtures

- 1 Select one or more fixtures in the channel grid. (Hold down the Command or Shift key as you click to select multiple fixtures.)
- 2 Do one of the following:
  - ▶ Drag the fixtures in the channel grid.
  - ▶ Double-click a fixture, then change the value in the "Start at" field.

## Change the DMX universe of one or more fixtures

- 1 Select one or more fixtures in the channel grid.
- 2 Drag the fixtures to one of the universes at the top. You can't drag fixtures to an input universe or Hue bridge.

## Duplicate fixtures

You can duplicate fixtures to quickly create new, independent fixtures of the same kind. Optionally, the new fixtures can adopt the properties of the existing one which are stored in presets. This can be useful if you extend your lighting installation: For example, assume you have a row of PARs for which you've created various presets, sequences, and cues. You can easily add another PAR to the row which behaves exactly like the others, without having to edit every preset.

### Duplicate fixtures

- 1 In the Fixture Manager, select one or more fixtures in the channel grid. (Hold down the Command or Shift key as you click to select multiple fixtures.)
- 2 Do one of the following:
  - ▶ Choose Edit → Duplicate (or press Command-D).
  - ▶ Control-click one of the fixtures and choose Duplicate from the shortcut menu.
  - ▶ Hold down the Option key and drag the fixtures in the channel grid.
- 3 In the dialog that appears, enter the desired number of copies.
- 4 Select or deselect the option "Adopt data in presets".

If the option is selected, Lightkey will copy all properties for the existing fixtures which are stored in presets to the new fixtures. In other words, the new fixtures will behave exactly like the existing fixtures.

If the option is not selected, Lightkey will simply create new fixtures with the same fixture profiles and modes.

- 5 Click Duplicate.

## Edit a fixture profile

You can conveniently edit fixture profiles in Lightkey's fixture editor. The fixture editor is built into the application so changes take effect immediately as you close the fixture profile.

### Edit a fixture's profile

Do one of the following:

- ▶ In the Fixture Manager, Control-click a fixture in the channel grid and choose Edit Profile from the shortcut menu.
- ▶ Hold down the Option key and double-click a fixture in the channel grid.
- ▶ Click a fixture's short name in the Preview, then select the top item in the shortcut menu and choose Edit Fixture Profile.
- ▶ Select a fixture in the Preview and choose Fixture → Edit Fixture Profile (or press Command-Shift-Option-Down Arrow).
- ▶ Hold down the Option key and double-click a fixture in the Preview.

❖ **Note:** Fixture profile information for the fixtures in a project is also stored in the project file, so you can use the project even if you don't have the fixture profiles. If a fixture's profile is not in your library, you can easily add it by editing the fixture's profile as described above.

## Reassign fixture profiles

When you replace a fixture with one of a different kind, you can assign the new light's fixture profile to the existing fixture in Lightkey. This retains the fixture's stored data in presets, sequences, and cues, as long as the stored properties exist in the new profile.

### Reassign a fixture profile

- 1 In the Fixture Manager, drag a fixture profile from the library to a fixture in the channel grid.
- 2 In the alert message that appears, select "Change all fixtures with this profile" if you want to replace the fixture profile throughout the project.
- 3 Click Change.



## Disable fixtures

If a fixture is temporarily disconnected, broken, or simply not in use, you can disable it in Lightkey. A disabled fixture shows no light beam, can't be selected in the Preview, and all its DMX channels are set to zero.

Disabled fixtures do not count towards the maximum number of output channels permitted by your Lightkey license. If your fixtures use more channels than are enabled by your license you can disable fixtures to decide which fixtures should receive output.

### Disable or enable a fixture

- ▶ In the Fixture Manager, Control-click a fixture in the channel grid and choose Disable or Enable from the shortcut menu.

❖ **Note:** You can also disable or enable fixtures in the Preview. See [Disable fixtures](#) in chapter 7, [Preview](#).

## Delete fixtures

When you delete a fixture from the project all information about the fixture is removed from presets, sequences, and cues. If you don't want to permanently delete the fixture you can disable it instead, as described in the preceding section.

### Delete fixtures

- 1 In the Fixture Manager, select one or more fixtures in the channel grid. (Hold down the Command or Shift key as you click to select multiple fixtures.)
- 2 Do one of the following:
  - ▶ Drag a fixture out of the channel grid.
  - ▶ Control-click a fixture and choose Delete... from the shortcut menu.
  - ▶ Press the Delete key.
- 3 In the alert message that appears, click Delete (or press Command-Delete).

▲ **Warning:** Deleting a fixture cannot be undone. All related data—for example, in presets, sequences, and cues—is removed from the project.

## Export and import fixtures

Lightkey can export a list of the fixtures in your project as a delimiter-separated text file, such as CSV (comma-separated values) or TSV (tab-separated values). You can import files back into another Lightkey project or into other applications such as DMX visualizers.

CSV and TSV files are structured in a simple, spreadsheet-like form: The first line contains column titles, and each following line represents a fixture. Many lighting control applications can import and export CSV and TSV files, even though the exact format varies from program to program. You can also import the files into spreadsheet applications or view them in a text editor.

### Export fixtures

- 1 In the Fixture Manager, click  in the toolbar. A dialog with export settings appears.
- 2 Select the columns which should be exported.

The universe and address can be exported as two separate columns or as a single column, depending on the requirements of the importing application. The same is true for the manufacturer and model.

The Position X and Position Y options export the fixtures' positions in the Preview. By default the values are in the Preview's coordinate system, which has no reference to physical units. You can click  and specify an origin and scale to transform the values into the coordinate system of the target application, e.g. a DMX visualizer. Lightkey can export fixture positions but does not import them.

- 3 Select a text encoding. The default selection, Unicode (UTF-8), is compatible with most other applications.
- 4 Choose which character should be used as field delimiter.
- 5 Click Save...
- 6 In the dialog that appears, enter a filename, choose a location, and click Export.

You can import files previously exported from Lightkey or from other applications. Based on the imported information, Lightkey will add new fixtures to your project or update the existing fixtures.

## Import fixtures

- 1 Click  in the toolbar.
- 2 In the dialog that appears, select a text file containing fixture information. The file must use the CSV (comma-separated values) or TSV (tab-separated values) format; the field delimiter can also be a semicolon. The first line must contain column titles.

In most cases Lightkey can automatically detect the text encoding and field delimiter. If necessary, you can click Show Options and explicitly choose a text encoding and field delimiter.

- 3 Click Continue.
- 4 The next dialog lets you determine how Lightkey interprets the information in each data column. The left table column contains fixture information Lightkey can import. In the right column, you can select which column the data should be taken from (if any).

If the imported file was exported from Lightkey, Lightkey can automatically map all columns and no changes are necessary. If the file was created by another application, Lightkey tries to map the columns based on their title, but you may need to adjust the settings to ensure all data is imported correctly.

The universe and address can be in separate columns or in a single column. The same is true for the manufacturer and model.

At least the following information is required to import a fixture:

- Universe and address
- Manufacturer and model

The external reference can be used to import values which another application uses to identify fixtures. When you import updated data from the other application at a later time, Lightkey can use the external reference to determine if a fixture already exists. The external reference can also be included when exporting fixture data.

Below the table you see the results of importing the file with the current settings:

- **New fixtures:** The number of fixtures that will be added.
- **Updated fixtures:** The number of fixtures that already exist in the project and will be updated with the imported information.

- **Skipped lines:** The number of lines that can't be imported (not counting the header row). This may be because required information is missing, in the wrong format, or its value is invalid.

5 To specify the handling of fixtures that already exist in the project, click More Options...

- Choose whether Lightkey should compare the short names or external references to determine whether a fixture already exists.
- When Lightkey finds that an imported fixture already exists in the project, it can:
  - Update the fixture with the imported information,
  - Leave the fixture unchanged and ignore the imported information, or
  - Import the fixture anyway.

6 Click Continue.

7 The next dialog lets you map the imported manufacturer and model names to a fixture profile. The columns on the left show the imported data. Each row represents a combination of manufacturer, model, and mode which is used by one or more imported fixtures.

The columns on the right let you map this information to a manufacturer, fixture profile, and mode from Lightkey's fixture library. Lightkey automatically tries to find and select a matching fixture profile for each imported model.

If no fixture profile is selected for one or more rows ("No selection"), Lightkey cannot add the corresponding fixtures. (It may still use the information to update existing fixtures, though,)

8 Click Import. Lightkey adds or updates fixtures based on your settings. It may also add new universes.

If the result isn't as expected, you can choose Edit → Undo Import to revert the changes.

★ **Tip:** A quick way to import fixture information is to drag a CSV or TSV file to the channel grid.

## Print the patched fixtures

You can print a list of all fixtures in your project, including patching information and comments. This can be convenient when assigning DMX addresses to the lights or when working with equipment hiring companies.

### Print a list of the fixtures in a project

- 1 In the Fixture Manager, click  in the toolbar.
- 2 In the dialog that appears, click Print.

## Work with fixture profiles

The fixture library on the left side of the Fixture Manager contains all built-in, imported, and user-created fixture profiles.

### Manage favorite fixture profiles

You can mark frequently used fixture profiles as favorites to find them more easily. Favorites are marked with a ★.

#### Add a fixture profile to the favorites

- ▶ Control-click a fixture profile in the library and choose Add to Favorites from the shortcut menu. To remove a fixture profile from the favorites, choose Remove From Favorites.

#### View only favorite profiles

- ▶ Click ★ at the top of the fixture library.

### Edit a fixture profile

You can edit fixture profiles in Lightkey's built-in fixture editor. Changes take effect immediately as you close the fixture profile.

❖ **Note:** You can view built-in profiles in the fixture editor but you cannot make changes. Instead, you can duplicate the profile.

## Edit a fixture profile

Do one of the following:

- ▶ Select a fixture profile in the library, then click ⋮ and choose Edit Profile from the menu.
- ▶ Control-click a fixture profile in the library and choose Edit Profile from the shortcut menu.
- ▶ Hold down the Option key and double-click a fixture profile in the library.

The fixture editor opens. A complete discussion of the fixture editor is beyond the scope of this User Guide.

To close the fixture profile, click ✕ to the left of its name (at the top).

## Import a fixture profile

You can import any Lightkey fixture profile into your library. You can also import profiles in the formats SSL2 (Sunlite) and FXT or PFF (DMX FreeStyler).

### Import a fixture profile

- 1 Click ⋮ at the top of the fixture library and then choose Import Profiles... from the menu.
- 2 Select a fixture profile in one of the supported file formats (.lightkeyfxt, .ssl2, .fxt, .pff) and click Import.
- 3 If you're importing an SSL2 profile, enter the manufacturer and fixture name in the dialog that appears, then click Import.
- 4 If the profile already exists in your library, Lightkey will display a warning. You can either replace the existing profile or keep both profiles.

★ **Tip:** A quick way to import a fixture profile is to drag the file to the fixture library.

## Create a fixture profile

Lightkey's built-in fixture editor lets you create your own fixture profiles.

## Create a fixture profile

- ▶ Click **⋮** at the top of the fixture library and then choose **New Profile...** from the menu.

An interactive assistant will appear and ask you about the basic information for the fixture profile. Then Lightkey creates the fixture profile and opens it in the fixture editor. A complete discussion of the fixture editor is beyond the scope of this User Guide.

## Duplicate a fixture profile

You can duplicate a fixture profile and use it as a starting point for new profiles. Another reason to duplicate fixture profiles may be that you want to make changes to a built-in profile.

### Duplicate a fixture profile

- ▶ Control-click a fixture profile in the library and choose **Duplicate Profile** from the shortcut menu.

A copy of the profile is added to the library, which you can then edit in the fixture editor.

## Delete a fixture profile

You can move user-created fixture profiles to the Trash. Built-in profiles cannot be removed.

### Move a fixture profile to the Trash

- 1 Control-click a fixture profile in the library and choose **Move to Trash...** from the shortcut menu.
- 2 In the alert message that appears, click **Move to Trash**.

# Chapter 14

## DMX output and input

---

Lightkey provides numerous ways of DMX output and input. You can use USB–DMX interfaces from many manufacturers as well as the network protocols Art-Net, sACN (also called E1.31), and ESP Net.

DMX input/output is configured primarily in two places:

- The DMX Output pane of the Settings window contains application-wide settings for each output method.
- The Fixture Manager is where you patch your project's universes to a USB interface or network protocol.

### DMX Output settings

The DMX Output settings contain general settings for the various output/input methods. These settings are global to the application and apply to all projects.

#### Change DMX Output settings

- 1 Choose Lightkey → Settings... and click DMX Output.
- 2 Select an output method from the left, then change the settings on the right as appropriate.
- 3 Click Apply to apply your changes, or click Revert to leave the settings unchanged.



## Serial USB Interfaces

The Serial USB Interfaces output method includes the following USB–DMX interfaces: DMXking ultraDMX devices, Enttec DMX USB Pro, Jese DMX-TRI, Robe Universal Interface. Lightkey can control a single USB interface from this group.

These interfaces cannot be used together with Open DMX or Eurolite PRO interfaces. Only one of these three output methods can be enabled at a time. A green dot next to “Serial USB Interfaces” indicates that the method is enabled.

### Enable Serial USB Interfaces

- ▶ Select Serial USB Interfaces on the left and click Enable.

This implicitly disables the options Open DMX Interfaces and Eurolite PRO.

## Open DMX Interfaces

The Open DMX Interfaces output method includes the Enttec Open DMX USB interface and similar devices (but not the Enttec Open DMX Ethernet interface). Lightkey can control a single Open DMX interface.

Open DMX interfaces cannot be used together with serial USB or Eurolite PRO interfaces. Only one of these three output methods can be enabled at a time. A green dot next to “Open DMX Interfaces” indicates that the method is enabled.

Unlike most other USB–DMX interfaces, Open DMX devices don’t include a microprocessor to create the DMX stream. Instead they rely on the computer to send DMX frames in regular intervals. If the computer can’t provide the DMX data at a high enough speed, you may experience flicker. In this case you should try to reduce the DMX refresh rate.

### Enable Open DMX Interfaces

- ▶ Select Open DMX Interfaces on the left and click Enable.

This implicitly disables the options Serial DMX Interfaces and Eurolite PRO.

### Change the rate at which DMX data is sent

- ▶ Select an option from the “Refresh rate” pop-up menu.

★ **Tip:** When you enable the Open DMX Interfaces output method, Lightkey will ask for an administrator password each time you start the application. Therefore you should not enable this option unless you actually use an Open DMX USB interface.

## **Eurolite USB-DMX512-PRO MK2**

Enable this output method for the Eurolite USB-DMX512-PRO MK2 and Eurolite USB-DMX512-PRO Cable. Lightkey can control a single USB interface from this group.

These interfaces cannot be used together with serial USB or Open DMX interfaces. Only one of these three output methods can be enabled at a time. A green dot next to “Eurolite PRO” indicates that the method is enabled.

### **Enable Eurolite PRO**

- ▶ Select Eurolite PRO Interfaces on the left and click Enable.

This implicitly disables the options Serial DMX Interfaces and Open DMX Interfaces.

★ **Tip:** When you enable the Eurolite PRO output method, Lightkey will ask for an administrator password each time you start the application. Therefore you should not enable this option unless you actually use a Eurolite interface.

## **Other USB Interfaces**

This output method includes the following USB-DMX interfaces: Eurolite USB-DMX512-PRO, and Stage-Profi devices. Lightkey can control a single USB interface from this group.

No settings are required for these interfaces.

## **Art-Net**

Art-Net is a communication protocol for distributing DMX data over a computer network. It was developed by Artistic Licence and has been placed in the public domain. Art-Net can carry a large number of DMX universes, and Ethernet cabling or Wi-Fi are useful for covering long distances.

An Ethernet–DMX interface—also called an Art-Net **node**—translates between Art-Net and DMX. Since Art-Net is an open standard, you can use any interface which conforms to Art-Net version 1 or higher. Some fixtures can also connect to Art-Net directly, acting as an Art-Net node. This scenario is discussed later in this section.

Each node has an address which consists of a **net** (0–127) and **subnet** (0–15) value. (They should not be confused with the IP address and subnet mask.) In most cases you don't have to deal with these values. However, if your network contains multiple Art-Net nodes, make sure each one has a unique net/subnet pair.

A node can have up to four **ports**, each of which can input or output one DMX universe. Lightkey can control a single Art-Net node with up to four ports, so you can use up to four DMX universes for output or input. Your computer must be in the same local network and IP subnet as the Art-Net node.

Art-Net nodes require some configuration which is usually done through an on-device menu, a software tool provided by the manufacturer, or a web browser interface. Configuration includes the node's IP address, net and subnet, port directions (output vs. input), and universe numbers. It's particularly important to select the same universe number(s) on the node as in Lightkey; see [Configure universes](#) later in this chapter. For more information see the documentation of your Art-Net node.

► **Important:** Starting with macOS 15 Sequoia, Lightkey requires permission to connect to Art-Net interfaces. When you see a request for permission to access devices on local networks, click Allow. The message appears only once. If you previously clicked Don't Allow you can still grant permission in System Settings → Privacy & Security → Local Network.

In Lightkey, you configure Art-Net settings in the Art-Net section of Lightkey's DMX Output settings.

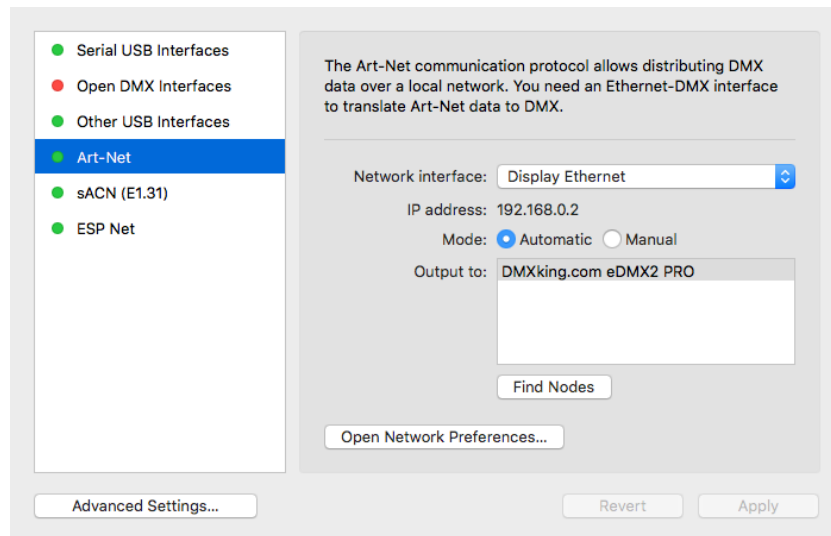

In most cases Lightkey can find connected Art-Net nodes automatically. If Lightkey can't find the node it often helps to connect it directly to your computer using an Ethernet cable in order to rule out network problems.

### Connect to an Art-Net interface using automatic mode

- 1 Open the DMX Output settings (as described earlier in this chapter) and click Art-Net on the left.
- 2 Select the network interface your Art-Net node is connected to. Your computer usually has multiple network interfaces such as Wi-Fi, the built-in Ethernet port etc. If you are not sure it may help to look at the Network pane of System Settings and check which network interfaces are in use (click Open Network Settings...).

Each of your computer's network interfaces has its own IP address. The IP address of the selected interface is shown below the network interface.

- 3 Select Automatic.
- 4 Click Find Nodes.

Lightkey finds any Art-Net nodes that are connected to the selected network interface and on the same local IP network.

- 5 Select your Art-Net interface in the list, if necessary.
- 6 Click Apply.

If your Art-Net interface has been found, proceed to [Configure universes](#) later in this chapter.

In rare cases it may be necessary to use manual mode and specify the exact net and subnet values. This applies to older Art-Net nodes which don't support the ArtPoll protocol.

### Connect to an Art-Net interface using manual mode

- 1 Select Art-Net on the left.
- 2 Select the network interface your Art-Net node is connected to.
- 3 Select Manual.
- 4 Fill in the following information:
  - **Net:** The Art-Net net of your interface (0–127).
  - **Subnet:** The Art-Net subnet of your interface (0–15).
  - **Options:** These are advanced options which should not be selected in most cases.
    - **Use broadcast mode:** Select this option for older Art-Net interfaces which only support Art-Net version 1. When selected, DMX data is sent to all devices on the network. This may significantly increase the network load and reduce the network's performance.
    - **Use limited broadcast:** Select this option to use the limited broadcast address (255.255.255.255) rather than the subnet-directed broadcast address when broadcasting. Some devices which don't follow the Art-Net specification require this.
    - **Use loopback device:** Select this if you want to receive Art-Net data on the same computer—for example, in a visualizer software.
- 5 Click Apply.

Some fixtures have an RJ45 (Ethernet) port and can receive Art-Net data directly from Lightkey. In this case no Art-Net interface is needed. If you want to send Art-Net data directly to fixtures, consider the following:

- All fixtures must use the same net and subnet. (They may be on different universes.)

- In Automatic mode, Lightkey finds all Art-Net nodes on the network, but only one can be selected. You can select any fixture in this case. As long as all fixtures use the same net and subnet, all will receive data. Alternatively you can use Manual mode and enter the net and subnet numbers manually.
- Some fixtures have special network requirements—for example, they might only work with IP addresses in the range 2.x.x.x or 10.x.x.x. Carefully read the fixture’s documentation for more information.

## sACN (E1.31)

Streaming ACN (sACN or ANSI E1.31) is a communication protocol for distributing DMX data over a computer network. It was developed by ESTA (Entertainment Services and Technology Association, now PLASA).

You use an Ethernet-DMX interface to translate sACN data to DMX. Some fixtures can also connect to sACN directly. This scenario is discussed later in this section.

► **Important:** Starting with macOS 15 Sequoia, Lightkey requires permission to connect to sACN interfaces. When you see a request for permission to access devices on local networks, click Allow. The message appears only once. If you previously clicked Don’t Allow you can still grant permission in System Settings → Privacy & Security → Local Network.

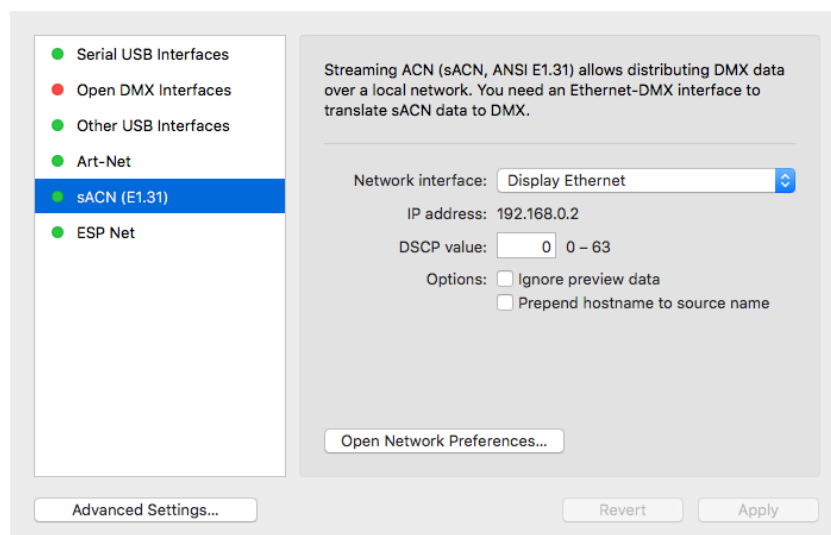

### Connect to an sACN interface

- 1 Select sACN (E1.31) on the left.

- 2 Select the network interface your sACN interface is connected to. Your computer usually has multiple network interfaces such as Wi-Fi, the built-in Ethernet port etc. If you are not sure it may help to look at the Network pane of System Settings and check which network interfaces are in use (click Open Network Settings...).

Each of your computer's network interfaces has its own IP address. The IP address of the selected interface is shown below the network interface.

- 3 The following options are available but should usually be left unchanged:
  - **DSCP value:** You can specify a DSCP (differentiated services code point) value to tag the IP packets with. This is an advanced feature; in most cases you should enter 0.
  - **Options:** These are advanced options that you will not need in most cases.
- 4 Click Apply.

❖ **Note:** When using sACN you can assign a priority to each universe. See [Configure universes](#) later in this chapter.

Some fixtures have an RJ45 (Ethernet) port and can receive sACN data directly from Lightkey. In this case no sACN interface is needed. In most cases all you need to do is ensure the fixtures and Lightkey are in the same local network and subnet. Consult the documentation that came with your fixtures for more information.

## ESP Net

ESP (Enttec Show Protocol) is a DMX-over-Ethernet communication protocol developed by Enttec.

➤ **Important:** Starting with macOS 15 Sequoia, Lightkey requires permission to connect to ESP Net interfaces. When you see a request for permission to access devices on local networks, click Allow. The message appears only once. If you previously clicked Don't Allow you can still grant permission in System Settings → Privacy & Security → Local Network.

## Set up DMX output through ESP Net

- 1 Select ESP Net on the left.
- 2 Select the network interface which your ESP Net interface is connected to. Your computer usually has multiple network interfaces such as Wi-Fi, the built-in Ethernet port etc. If you are not sure it may help to look at the Network pane of System Settings and check which network interfaces are in use (click Open Network Settings...).

Each of your computer's network interfaces has its own IP address. The IP address of the selected interface is shown below the network interface.

- 3 Click Apply.

### If you can't patch a universe to ESP Net

If ESP Net does not appear in the list of output methods for a universe, make sure the Enttec "Node Management Utility" (NMU) is not running. If it is, quit the NME application, then choose Lightkey → Reset DMX Output, and try again.

## Connect to an external OLA server

Lightkey outputs DMX through the Open Lighting Architecture (OLA), an open-source framework developed by the Open Lighting Project. You can install your own version of OLA on your computer, run an OLA server (olad) and redirect Lightkey's DMX output to it. This will open up additional DMX output and input options.

**▲ Warning:** Running Lightkey with an external OLA server is considered an experimental feature. There is no guarantee that it will work because the OLA client built into Lightkey may not be compatible with other OLA versions. We do not provide technical support for this feature.

## Direct Lightkey's DMX output to an external OLA server

- 1 Make sure your olad instance is running.
- 2 In the DMX Output settings, click Advanced Settings...



- 3 Select “Connect to an existing OLA server”. If the server does not use OLA’s default port number (9010), enter a different port number in the text field. The server must be running on the same computer.
- 4 Click OK.

Lightkey will attempt to patch the OLA server’s universes according to the settings in the Fixture Manager. If you want to patch a universe through another way (for example, OLA’s web or command-line interface), select “No output” or “No input” in the Fixture Manager. In this case Lightkey will still send or receive DMX but not re-patch the universe. This way you can use output or input methods that are not available in Lightkey, such as other OLA plug-ins.

## Configure universes

To output or input DMX you need to map or “patch” DMX universes to either a USB-DMX interface or a network protocol. You can use up to four universes for output, depending on your Lightkey license. You can use up to two universes for input.

### Add a universe

- 1 Click  in the toolbar or choose Lightkey → Manage Fixtures... to open the Fixture Manager.  
At the top of the Fixture Manager is a row of DMX universes and Hue bridges.
- 2 Click + (next to the last universe or Hue bridge).
- 3 Click Add DMX Universe. A new universe is added.
- 4 Change the universe’s settings as described below.

Each universe has a unique number. Usually these numbers are simply 1, 2, and so on, but you can assign any number to a universe. This can be useful with network protocols which carry multiple DMX universes. The universe numbers must match the settings on the network interface, as explained in [Configure universes on a network node](#) below.

- **Art-Net:** You can use any universe number from 0 to 15. An Art-Net node address consists of the net (0 – 127), subnet (0 – 15), and universe number, giving a total of 32,768 values. When you create a project with Art-Net, the default universe number is 0, which is also the default of many Art-Net nodes.

- **sACN:** Possible universe numbers range from 1 to 63,999. Note that you cannot use 0.
- **ESP Net:** You can use any number from 0 to 511.

Universe numbers are mostly irrelevant for USB–DMX interfaces—their only purpose is to define the universes’ order. If an USB interface has multiple output ports, patch multiple universes to the interface. For example, if you patch universes 2 and 3 to an Enttec DMX USB Pro Mk2 interface, universe 2 is mapped to the first output port and universe 3 is mapped to the second output port.

### Configure a universe

- 1 Move the pointer over a universe at the top of the channel grid and click the arrow on the right.



Below the universe, a window with patching details appears:

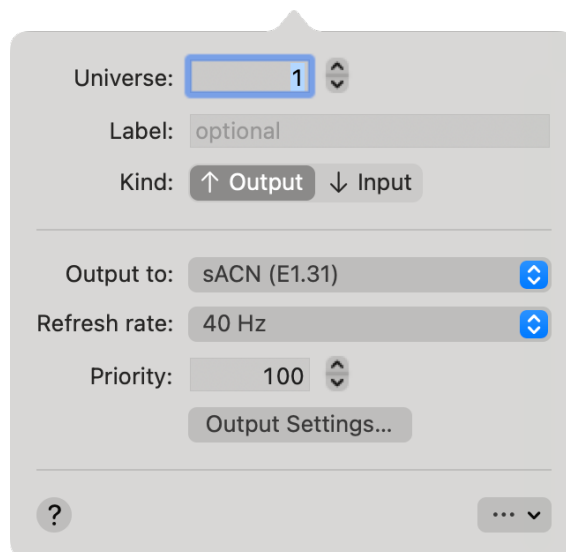

- 2 Enter a universe number in the Universe field. Universe numbers are mainly relevant for network protocols, as described above.
- 3 You can add an optional label to identify the universe.
- 4 Select Output to send DMX to the interface or Input to receive DMX for external control.

5 For output universes, the following options are available:

- **Output to:** Select a USB–DMX interface or one of the network protocols (Art-Net, sACN, or ESP Net interfaces do not appear in the menu). If your USB interface is not in the menu, see [If your USB–DMX interface does not appear](#) below.
- **Refresh rate:** This controls how often Lightkey generates new DMX values for the universe. For best results this should match the rate at which your DMX interface sends DMX frames to the fixtures.

If you're using an Open DMX interface then the refresh rate always matches the rate at which the interface sends DMX frames to the fixtures, so it cannot be changed.

- **Priority:** This field sets the universe priority for sACN, a value between 0 and 200. Priorities can be useful when sending data to an sACN node which merges multiple sources. The priority is not used for other output methods.

For input universes, the following option is available:

- **Input from:** Select a USB–DMX interface or one of the network protocols. If your USB interface is not in the menu, see [If your USB–DMX interface does not appear](#) below.

6 Click Done in the toolbar to close the Fixture Manager and apply your changes. (Your changes won't take effect until you close the Fixture Manager.)

## Delete a universe

- 1 Move the pointer over a universe at the top of the channel grid and click the arrow on the right.
- 2 Click ⋮ and choose Delete Universe from the menu.
- 3 If an alert message appears, click Delete (or press Command-Delete).

▲ **Warning:** Deleting a universe removes all fixtures in the universe, and the associated data, from the project.

## Configure universes on a network node

If you output DMX through a network protocol like Art-Net or sACN, you need to select the same universe number(s) on the network interface as in Lightkey. This is usually done through an on-device menu, a software tool provided by the manufacturer, or a web browser interface; consult the documentation of your interface for details.

A special pitfall is that some Art-Net interfaces (e.g. DMXking eDMX) use universe numbers which are offset by one from Lightkey's:

Lightkey universe number	Device universe number
0	1
1	2
⋮	⋮

In this case you must add 1 to Lightkey's universe numbers when you configure the Art-Net node.

## If your USB–DMX interface does not appear

Here are some helpful tips if your USB–DMX interface does not appear in a universe's "Output via" or "Input via" pop-up menus:

- Check if your interface is on the [list of compatible interfaces](#). Interfaces that are not listed may not work with Lightkey.
- Connect the USB–DMX interface to your computer, then choose Reset DMX Output from the Lightkey menu. Now check if your device is found.
- Lightkey requires a number of device drivers to work with the various USB–DMX interfaces, which are installed by the Lightkey installer. If a driver is missing, a warning will appear in the DMX Output section of Lightkey's Settings window. When in doubt, run the Lightkey installer again.
- If you have an Open DMX (or similar) interface, make sure the output method "Open DMX Interfaces" is enabled in the "DMX Output" pane of Lightkey's Settings window. On the other hand, if you have a serial USB interface, make sure the output method "Serial USB Interfaces" is enabled. Only one of these methods can be enabled at a given time.

- Sometimes it is necessary to restart your computer after installing Lightkey, to make sure the device drivers are properly loaded. This is usually necessary only once after installing Lightkey.
- In some cases it helps to unplug the device and replug it after about one minute. Sometimes it helps to plug the interface into a different USB port.
- There may be conflicts if other applications try to access your DMX interface. Please quit all other lighting control applications, then choose Lightkey → Reset DMX Output. If your interface still doesn't appear, restart your computer and then open Lightkey again.

## Monitor DMX output

You can observe the current DMX output or input values for a universe or individual fixtures. This is useful to track down problems when fixtures don't respond or deviate from what's shown in the Preview.

### View the DMX output or input for a universe

- 1 Choose Window → DMX Monitor (or press Command-Shift-Option-0). The DMX Monitor window appears.
- 2 Select a universe from the pop-up menu at the top.
- 3 Rest the pointer over one of the DMX channels. A help tag appears showing the corresponding fixture and property (applies to output universes only).

### View the DMX output for one or more fixtures

- 1 Select one or more fixtures in the Preview.
- 2 Choose Fixture → Show DMX Output.

If you keep the DMX Monitor window open and select different fixtures, the output display updates accordingly.

# Chapter 15

## Smart lights

---

Smart lights can be a simple and cost-effective complement to DMX lighting in many venues. Starting with version 4 you can add Philips Hue lights to your Lightkey projects and control them alongside your DMX lights.

Lightkey can control bulbs, LED strips, plugs, and other types of lights of the Philips Hue brand. Smart lights from other manufacturers which connect to a Philips Hue bridge will often work as well, but we cannot guarantee compatibility with them.

To control Philips Hue lights with Lightkey you need:

- a Lightkey license which includes smart lights,
- a Mac computer running macOS 12 or later,
- a Hue bridge version 2 or newer (square shaped) whose firmware version is at least 1948086000. Lightkey cannot control Hue lights through Bluetooth.

When you add smart lights to Lightkey it is still possible to control them by other means such as the Hue app or smart wall switches. However, changes from other controllers will not show in Lightkey's Preview.

❖ **Note:** Lightkey doesn't replace the official Hue app for iOS. You still need the Hue app to set up your bridge and for tasks like adding lights, managing rooms and zones, etc.

## Smart lights vs. DMX

At the center of your Hue system is the Hue bridge, the link between your Mac and your smart lights. An Ethernet cable connects the bridge to your Mac or a router. The Hue bridge receives commands from Lightkey and transmits them wirelessly to lights and plugs. Each light repeats the commands and passes them on to others. This creates a wireless network which consumes very little power, but both the number of commands sent and the range of transmission are limited.

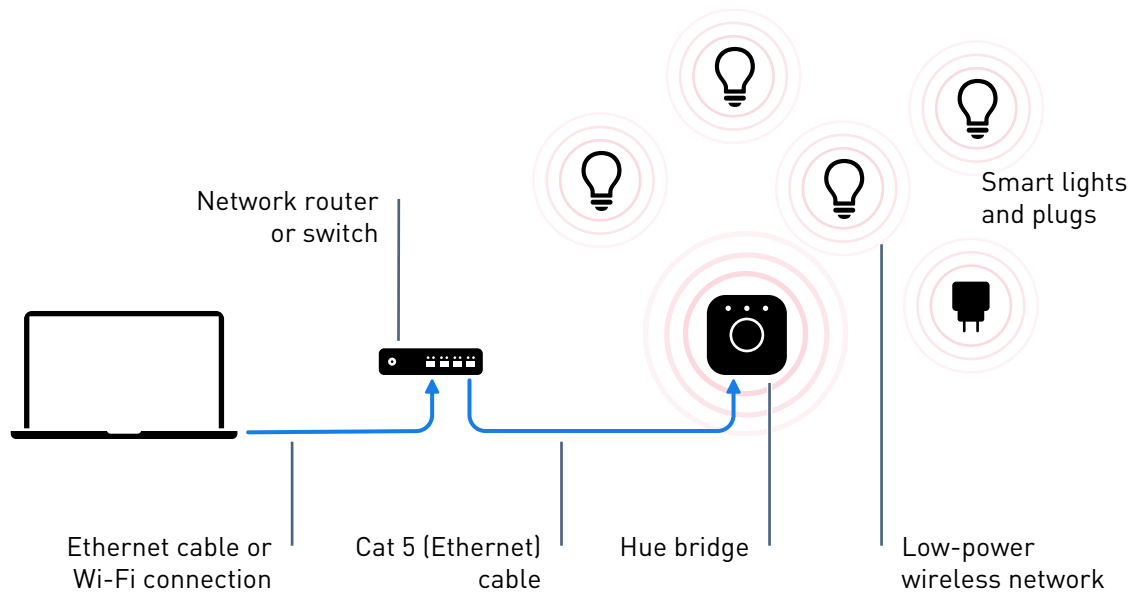

There are some fundamental differences between DMX and smart lights which you need to be aware of.

- **Smart lights take (much) longer to respond.** The low-power wireless network which connects Hue lights to the bridge has a significantly higher latency than DMX, therefore it takes longer for smart lights to turn on or off or change their color. If you turn on or change multiple lights, each of them may respond with a different delay (called “popcorn effect”).
- **Smart lights can handle a limited amount of commands.** The Hue network can only transmit a small number of messages per second. If you change the lights too fast they may take longer to respond or may not respond at all. The exact timing depends on the number of lights in your network, other apps in the network, additional traffic on the network such as software downloads, the distance of the lights from the Hue bridge and from each other, and other factors.

When integrating smart lights into your show, keep the following guidelines in mind:

- **Don't use effects and sequences with smart lights.** Effects and fast sequences usually cause a continuous stream of light changes which would overload the Hue network. In particular, do not use beat-controlled effects or sequences; this will not work due to the higher latency.
- **Don't use fade times with smart lights.** Cue and sequence fade times are ignored for smart lights. They always use a fixed fade time which cannot be changed at this time.
- **Divide smart lights into rooms and zones.** Lightkey can reduce the messages sent when identical properties are applied to an entire room or zone, thus avoiding the “popcorn effect”. Use the Hue iOS app to combine lights which are often used together in a room or zone. (Lightkey doesn't show zones but still uses them for optimizations.) This applies to groups of five or more lights.

## Manage Hue bridges

Before you can add your Hue bridge to Lightkey, make sure it's on the same local network as your Mac (that is, both connect to the same router). You should also verify that the Hue bridge is using the latest firmware version. To do this, turn on automatic firmware updates in the Hue iOS app.

➤ **Important:** Starting with macOS 15 Sequoia, Lightkey requires permission to connect to Hue bridges. When you see a request for permission to access devices on local networks, click Allow. The message appears only once. If you previously clicked Don't Allow you can still grant permission in System Settings → Privacy & Security → Local Network.

## Add a Hue bridge

You can add multiple Hue bridges to a project and control their lights at the same time (for example, if the lights are in different rooms).



## Add a Hue bridge to a project

- 1 Click  in the toolbar or choose Lightkey → Manage Fixtures... to open the Fixture Manager.

At the top of the Fixture Manager is a row of DMX universes and Hue bridges.

- 2 Click + (next to the last universe or Hue bridge).
- 3 Click Add Hue Bridge...
- 4 Wait for your Hue bridge to appear.
- 5 Press the button on the front side of your Hue bridge.

This permanently links Lightkey to the Hue bridge.

Once your Hue bridge has been added, it appears in the bar at the top of the Fixture Manager next to your DMX universes. Click the Hue bridge to see its rooms and fixtures.

❖ **Note:** You must assign your Hue lights to a room for Lightkey to see them.

## View Hue bridge details

- ▶ Move the pointer over a Hue bridge and click the arrow on the right.

A window with details about the Hue bridge appears.

If you made changes to the Hue bridge's settings, such as adding a light, while the Fixture Manager is open, you can update the information in the Fixture Manager to reflect the changes.

## Update Hue bridge information

- ▶ Choose Lightkey → Reset Hue Output.

## Relink Lightkey to a Hue bridge

If Lightkey cannot connect to a Hue bridge you previously added to a project, you may see an error message which says "Lightkey is no longer linked to the Hue bridge." This can happen after a factory reset of the Hue bridge or if Lightkey has been unlinked through the Hue web interface.

## Relink Lightkey to a Hue bridge

- 1 Choose Lightkey → Manage Fixtures...  
If Lightkey still cannot connect to the Hue bridge another error message appears.
- 2 Click Relink... below the error message.
- 3 Press the button on the front side of your Hue bridge.

## Delete a Hue bridge

When you delete a Hue bridge, the fixtures and the associated data are removed from the project.

### Remove a Hue bridge

- 1 Move the pointer over a Hue bridge and click the arrow on the right.  
A window with details about the Hue bridge appears.
- 2 Click ⋮ and choose Delete Hue Bridge... from the menu.
- 3 In the dialog that appears, click Delete.

## Manage smart lights

The primary place for managing your smart lights remains the Hue iOS app. This is where you add lights to a Hue bridge, set up rooms and zones, and move lights between rooms and zones, for example.

You can view your smart lights in Lightkey's Fixture Manager. Click a Hue bridge in the bar at the top to see the associated rooms and fixtures in the area below.

### View and edit Hue fixture information

Lightkey may display a status label below the name of a Hue fixture. The label can be one of the following:

---

<b>Unreachable</b>	The Hue bridge is unable to connect to the light. Make sure the light is connected to power and try placing it closer to the Hue bridge.
<b>Removed</b>	The light has been removed from the Hue bridge.

---

You can view and edit details about a Hue fixture such as its short name. Changing these details will not affect your presets, sequences, and cues.

## View and edit information about a fixture

- 1 Do one of the following:
  - ▶ Double-click a fixture.
  - ▶ Control-click a fixture and choose Get Info from the shortcut menu.
- 2 The following information is shown below the fixture:

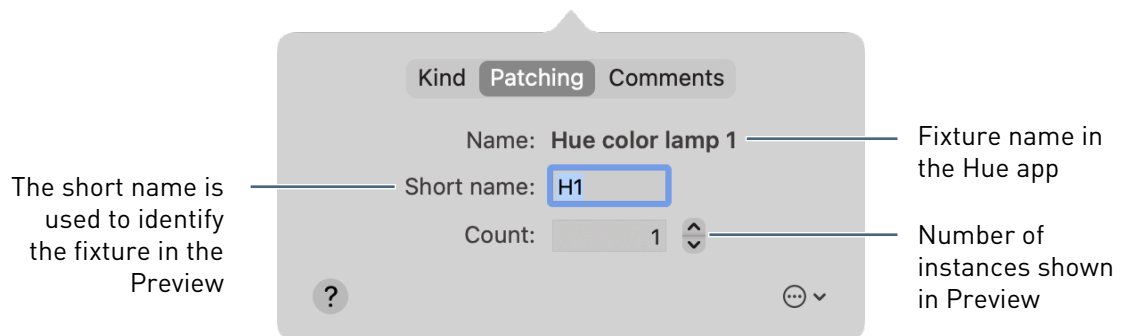

## Reveal one or more fixtures in the Preview

- 1 Select one or more fixtures. (Hold down the Command or Shift key as you click to select multiple fixtures.)
- 2 Control-click one of the fixtures and choose Show in Preview from the shortcut menu.

## Identify a fixture

- ▶ Control-click a fixture and choose Identify from the shortcut menu. The light will briefly change its brightness.

## Add a Hue fixture

To add a new light, you first use the Hue iOS app to add it to your Hue bridge. Then add a new fixture in Lightkey.

### Add a Hue fixture

- 1 Add the new light to your Hue bridge using the Hue app. Make sure to assign the light to a room.
- 2 In Lightkey, click  in the toolbar or choose Lightkey → Manage Fixtures...

- 3 Click the Hue bridge in the bar at the top to select it.

The new fixture appears in the area below and is marked with a star.

- 4 Click Done.

## Replace a Hue fixture

If you replace a Hue fixture with another, it will appear as a new fixture in Lightkey. You can tell Lightkey to adopt the previous fixture's data so presets and cues continue to work as before. You can also use this approach when you add a new fixture and want it to adopt the behavior of the existing fixture.

### Replace a Hue fixture

- 1 Add the new light to your Hue bridge using the Hue app.
- 2 In Lightkey, click  in the toolbar or choose Lightkey → Manage Fixtures...
- 3 Click the Hue bridge in the bar at the top to select it.  
The area below shows the existing lights and the new light which is marked with a star.
- 4 Control-click the new light and choose Adopt Data From... from the shortcut menu.
- 5 In the dialog that appears, select the original fixture and then click OK.
- 6 Click Done.

## Move a fixture between Hue bridges

When you move a Hue fixture from one Hue bridge to another, Lightkey can preserve the data for the fixture so presets and cues continue to work as before. You can also use this process when you replace a Hue bridge with a new device.

### Move a fixture between Hue bridges

- 1 Use the Hue app to delete the light from the original Hue bridge.
- 2 Switch to the new Hue bridge in the Settings area of the Hue app.
- 3 Add the light to the new Hue bridge, and assign it to a room.
- 4 In Lightkey, click  in the toolbar or choose Lightkey → Manage Fixtures...

When you select the original Hue bridge, the fixture still appears but is marked as “Removed”.

- 5 Click the new Hue bridge in the bar at the top to select it. (If you haven't added the Hue bridge to the project yet you can add it now.)

The area below shows the new light which is marked with a star, indicating it's a new fixture.

- 6 Control-click the new light and choose Adopt Data From... from the shortcut menu.
- 7 In the dialog that appears, select the original fixture on the and then click OK.
- 8 Click Done.

## Disable a fixture

If a fixture is temporarily disconnected, broken, or simply not in use, you can disable it in Lightkey. A disabled fixture shows no light beam, can't be selected in the Preview, and Lightkey doesn't send commands to it.

Disabled fixtures do not count towards the maximum number of smart lights permitted by your Lightkey license. If you have more smart lights than are enabled by your license you can disable fixtures to decide which fixtures should be controlled.

## Disable or enable a fixture

- ▶ Control-click a fixture in the channel grid and choose Disable or Enable from the shortcut menu.

❖ **Note:** You can also disable or enable fixtures in the Preview. See [Disable fixtures](#) in chapter 7, [Preview](#).

## Delete a fixture

Lights removed from a Hue bridge are not automatically removed from your Lightkey project. Perform the following steps to remove the fixtures and the associated data from your Lightkey project.

## Delete a Hue fixture

- 1 Use the Hue app to remove the light from the bridge.
- 2 In Lightkey, click  in the toolbar or choose Lightkey → Manage Fixtures...
- 3 Click the Hue bridge in the bar at the top to select it.

The area below shows the lights connected to the bridge. The removed light still appears and is marked as “Removed”.

- 4 Control-click the fixture and select Delete... from the shortcut menu.
- 5 In the dialog that appears, click Delete.

# Chapter 16

## External control

---

Lightkey has extensive support for integrating with hardware and software through DMX, MIDI, OSC, custom keyboard shortcuts, and the system-wide shortcuts feature.

Hardware controllers like DMX consoles and MIDI controllers provide an intuitive and ergonomic way to control your show during live performances. Lightkey lets you map their faders, buttons, and wheels to numerous software functions like activating cues or adjusting modifiers. It also sends feedback to connected MIDI controllers so their LEDs and motorized faders always match the state of the software.

Beyond that you can control Lightkey from any other software that sends DMX, MIDI, or OSC messages. The external control system provides access to all important application features, down to individual fixture properties. Lightkey can also send MIDI to other applications.

Other ways to control Lightkey include the macOS shortcuts feature which lets you build custom workflows and automations. Finally, Live Triggers is a unique feature to trigger cues directly from Ableton Live's timeline, enabling you to create fully automated light shows that run in sync to the music.

In more detail, Lightkey can receive input through the following technologies:

- **DMX-In:** Many USB–DMX interfaces and Ethernet–DMX interfaces have input ports to feed DMX into your computer. This lets you control Lightkey from DMX consoles or other hard- or software which outputs DMX.

- **MIDI:** MIDI (Musical Instrument Digital Interface) is an established technology for sending real-time messages between a wide variety of electronic music devices, control surfaces, and software. You can control Lightkey from any hardware or software that can send MIDI data.

Many MIDI controllers connect to your computer through the USB port. If a MIDI device has MIDI-In and Out ports instead, you can connect it through a MIDI-USB interface.

- **Keyboard:** In addition to the built-in keyboard shortcuts, Lightkey lets you define your own shortcuts. For example, you can assign keys to the cues in the Live view. You can use all letters, numbers, punctuation characters and the function keys (F1, F2, ...) in combination with the Shift, Control, and Option modifier keys.
- **OSC:** Open Sound Control is a communication protocol for sending short messages over a computer network. Many Mac and iOS applications can send OSC, including QLab, TouchOSC, Lemur, and Vezér. Each OSC-controllable element in Lightkey has an address, so it's not necessary to first create trigger-action bindings. See [Open Sound Control \(OSC\)](#) later in this chapter for more information.
- **Shortcuts:** Shortcuts are a system-wide automation feature in macOS which also integrates with Siri. You can create and edit shortcuts in the Shortcuts app. See [macOS shortcuts](#) later in this chapter for details.

Lightkey's external control system is highly configurable, allowing you to custom-tailor it to your specific setup and requirements. You can create multiple external control configurations, which is useful for different environments or users.

External control settings are stored as part of your project, because actions like activating a cue are specific to the project. You can export and import configurations to transfer them between projects.

## Quickly assign triggers

Lightkey provides a quick and convenient way to assign DMX-In, MIDI, and keyboard triggers to many elements in the user interface. For example, this works for cues in the Live view and many buttons and sliders in the Design view.

A more comprehensive way to create and edit triggers and actions is through the External Control window, which is described in the following section.



### Quickly assign a trigger to an element

- 1 Control-click an element in the user interface (e.g. a button or slider) and choose External Control → Add Trigger... from the shortcut menu. This command is only available for elements which support external control.
- 2 Do one of the following:
  - ▶ Operate a fader on a connected DMX console.
  - ▶ Operate a fader, button, or wheel on a connected MIDI controller.
  - ▶ Press a key or key combination on the keyboard.

Triggers assigned through this method also appear in the External Control window, where you find additional options.

### Quickly replace a trigger

- 1 Control-click an element in the user interface and choose External Control → Replace Trigger... from the shortcut menu.
- 2 Operate a new trigger.

### Quickly remove a trigger

- ▶ Control-click an element in the user interface and choose External Control → Remove Trigger from the shortcut menu.

❖ **Note:** The Replace Trigger... and Remove Trigger commands are only available when an element has exactly one trigger. If it has more than one you must replace or delete the trigger in the External Control window.

If you have a MIDI controller with feedback LEDs or motorized faders, Lightkey can show you which hardware control a user interface element is bound to.

### See which hardware control a user interface element is bound to

- ▶ Control-click an element in the user interface and choose External Control, then move the pointer over a trigger in the menu. The corresponding LED on a MIDI controller will flash, or the corresponding fader will move.

## View a trigger in the External Control window

- ▶ Control-click an element in the user interface and choose External Control, then select a trigger from the menu.

## The External Control window

The central place for configuring Lightkey's external control system is the External Control window.

### Open the External Control window

- ▶ Choose Window → External Control (or press Command-E).

The External Control window is divided into three categories which appear at the top: DMX-In, MIDI, and Keyboard. Below is a pop-up menu where you can select and edit configurations for the current category. The main part of the window shows a list of the trigger-action bindings for the selected configuration.

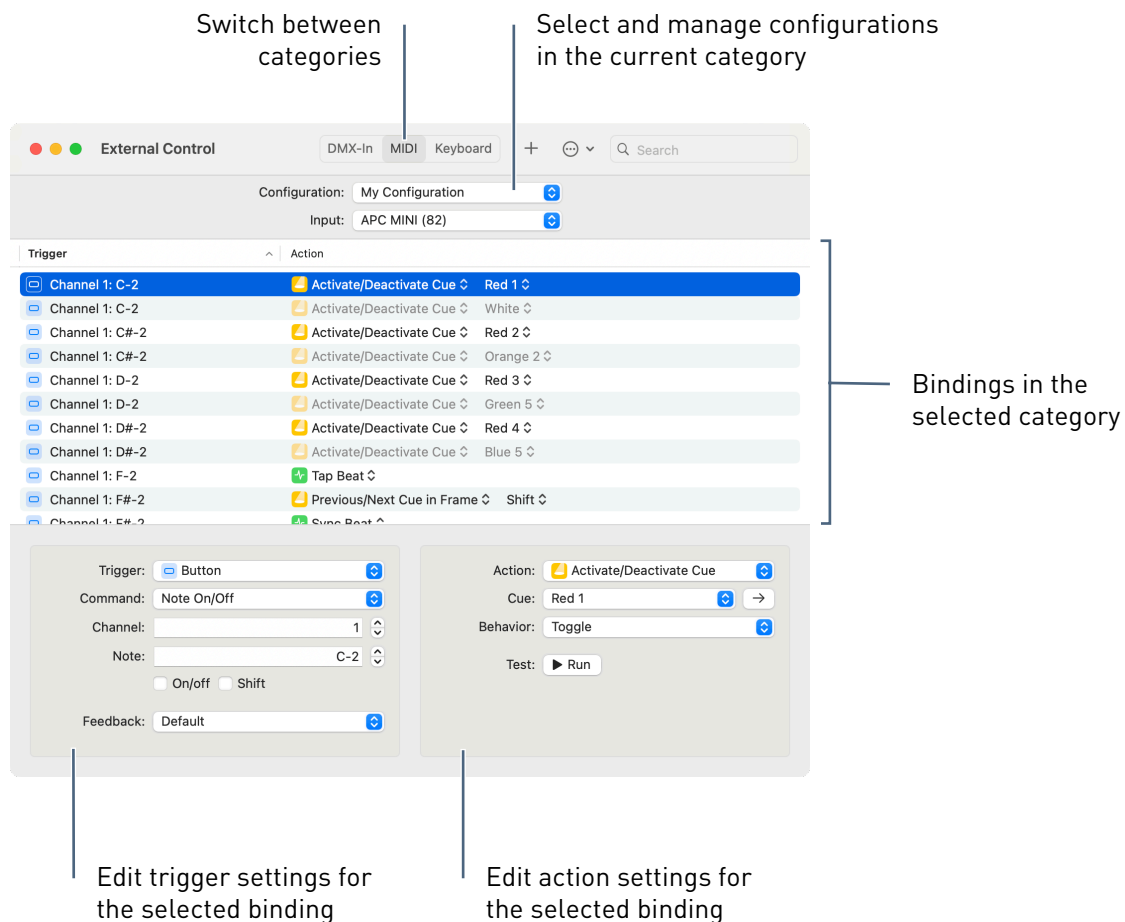

## Configurations

For each category of external control devices (DMX-In, MIDI, Keyboard) you can save multiple **configurations** of external control bindings. This is useful if your control hardware changes or Lightkey is used in different scenarios or by several people. Only one configuration per category can be active at a time. Configurations can be exported to a file and imported again, which allows you to move them between projects or share them with others.

The Configuration pop-up menu shows the control configurations for the selected category. The selected configuration is the one currently in effect.

### Manage configurations

- 1 Choose Manage Configurations... from the Configurations pop-up menu.

A window with a list of configurations appears.

- 2 Change the configurations as appropriate:

- ▶ **To add a new, empty configuration:** Click **+**, then enter a name for the new configuration and press Return.
- ▶ **To reorder configurations:** Drag the rows in the list up or down.
- ▶ **To rename a configuration:** Select the configuration, then click **⋮** and choose Rename from the menu. Alternatively, select the configuration and click its name.
- ▶ **To duplicate a configuration:** Select the configuration, then click **⋮** and choose Duplicate from the menu. Enter a name for the new configuration and press Return.
- ▶ **To export a configuration to a file:** Select the configuration, then click **⋮** and choose Export... from the menu. In the dialog that appears, enter a filename, choose a location, and click Save.
- ▶ **To import a configuration file:** Click **⋮** and Choose Import... from the menu. In the dialog that appears, navigate to the configuration file and click Import. If a previous version of the configuration already exists in the project, Lightkey will display a warning. You can either replace the existing configuration or keep both.
- ▶ **To delete a configuration:** Select the configuration and click **—** or press the Delete key.

### 3 Click Done.

❖ **Note:** The configuration named Live Triggers is a special configuration for communicating with Ableton Live. It is created automatically and can't be edited. You cannot delete this configuration unless you disable Live Triggers in the Settings window. For more information see [Live Triggers](#) later in this chapter.

## MIDI inputs

When the MIDI category is selected, a pop-up menu labelled Input appears below the Configuration menu which lets you choose between the connected MIDI inputs. Lightkey normally associates bindings with the input from which the MIDI message was received, and sends feedback only to the corresponding output. This allows simultaneous control from multiple controllers, even if they send on the same MIDI channel.

❖ **Note:** Lightkey relies on the input name to distinguish between MIDI inputs. If you have two or more MIDI controllers of the same type, it is therefore important that they have unique names. You can change the names in the app Audio MIDI Setup (in Applications → Utilities).

The bindings list shows the bindings for the selected input. Note that Lightkey responds to MIDI messages from all inputs, not just the selected one.

The input named Lightkey Input can be used to receive MIDI from other applications. It appears as destination in other MIDI-capable apps, eliminating the need to use a virtual MIDI bus (like the IAC Driver) to send MIDI between apps. Feedback for bindings in Lightkey Input is sent to the Lightkey Output port.

It's also possible to create bindings which are not associated with a MIDI input. Those bindings respond to messages from any input and send feedback to all outputs. They are shown when you select Any in the Input pop-up menu.

If necessary you can use copy and paste to move bindings between inputs.

## Associate MIDI bindings with a different MIDI input

- 1 Select one or more bindings.
- 2 Choose Edit → Cut.
- 3 In the Input pop-up menu, select the input you want to associate the bindings to.
- 4 Choose Edit → Paste.

You can select which outputs and inputs are used for receiving and sending MIDI. This is described in [MIDI routing](#) later in this chapter.

## Bindings

The central part of the External Control window shows a list of trigger–action pairs called **bindings**. A **trigger** describes an operation on an external control device, like pushing a button on a MIDI controller or operating a fader on a DMX console. An **action** describes how Lightkey should respond to the trigger. For example, an action may activate a particular cue or change the gobo rotation speed.

There are three kinds of triggers:

- **Button:** Buttons send a single message when pressed, and possibly another when depressed. They're used for actions like tapping the beat or activating a cue.
- **Fader/knob:** Faders or knobs represent a value within a finite range. Use them for actions like controlling the Master Dimmer or crossfading between cues.
- **Wheel:** Wheels are infinite controls like jogwheels or rotary knobs. They can increase or decrease a continuous value like the Master Dimmer. Wheel triggers are only available for MIDI bindings.

Keyboard triggers are always button-type triggers.

The quickest way to create bindings is to operate a trigger and have Lightkey “capture” it.

❖ **Note:** Before you can create DMX-In bindings, you must set up at least one universe for DMX input. This connects the universe to a DMX interface's input port. See [Configure universes](#) in chapter 14, [DMX output and input](#) for more information.

## Create a binding by capturing a trigger

- 1 Open the External Control window and select a category (DMX-In, MIDI, or Keyboard).
- 2 For MIDI triggers, select the input to which the message will be sent, or select Any.
- 3 Operate a trigger:
  - ▶ **DMX-In:** Operate a fader or button on a DMX console. Lightkey creates a matching binding and automatically detects the trigger type (button or fader).
  - ▶ **MIDI:** Press a button, move a fader, or turn a wheel on a MIDI controller. Lightkey creates a matching binding and automatically detects the trigger type (button or fader).
  - ▶ **Keyboard:** Press a key on the keyboard. Lightkey creates a button-type binding for that key. You can use all letters, numbers, punctuation characters and the function keys (F1, F2, ...) in combination with the Shift, Control, and Option modifier keys. (The Command key is reserved for Lightkey's standard keyboard shortcuts.)

A new binding is added to the list and selected. (If the trigger was already assigned to an existing binding, that binding is selected instead.)

❖ **Note:** If no binding is created when you operate a trigger, click ☰ in the toolbar and make sure Automatically Create Bindings is selected.

Lightkey automatically detects if a control sends a single message or continuous values, and sets the trigger type to either button or fader. However, it cannot detect wheels, so if the control is an infinite wheel then you need to change the trigger type after creating the binding.

## Manually create a binding

Do one of the following:

- ▶ Click + in the toolbar.
- ▶ Control-click in the bindings list and choose New Binding from the menu.

After creating a binding, configure its action in the area below the bindings list (see [Actions](#) below). Note that some actions are only available for button triggers, others only for fader or wheel triggers.

### Find the binding associated with a control

- ▶ Operate the control. Lightkey selects the corresponding binding in the list.

❖ **Note:** If the binding is not selected, click ☰ in the toolbar and make sure Automatically Select Bindings is selected.

You can use text search to filter the list of bindings. Only bindings whose trigger or action contains your search text will be shown.

### Search the visible bindings

- ▶ Enter one or more words in the search field in the toolbar.

Because only one Live page can be selected at any time, bindings that apply to cues or frames on other pages are ignored. The actions for those bindings appear gray in the list. You can also choose to hide the bindings entirely.

### Hide bindings for inactive Live pages

- ▶ Click ☰ in the toolbar and choose one of the following options:
  - **All:** Shows all bindings for the current configuration and input.
  - **Hide Inactive Live Pages:** Hides bindings for objects on inactive Live pages.

### Duplicate a binding

- 1 Select one or more bindings.
- 2 Do one of the following:
  - ▶ Choose Edit → Duplicate or press Command-Shift-D.
  - ▶ Control-click a binding and choose Duplicate

You can use cut, copy and paste to move bindings between different configurations or MIDI inputs. You can only move bindings within the same category (DMX-In, MIDI, or Keyboard).

### Move bindings between configurations or MIDI inputs

- 1 Select one or more bindings.
- 2 Choose Edit → Cut.
- 3 Select a different configuration or input.
- 4 Choose Edit → Paste.

### Delete bindings

Do one of the following:

- ▶ Select one or more bindings, then press the Delete key.
- ▶ Control-click the binding and choose Delete from the menu.

If you accidentally deleted a binding, choose Edit → Undo Delete Binding.

Sometimes Lightkey inadvertently captures a trigger and creates a binding for it. Those bindings often have no actions or actions with missing parameters. There's an easy way to clean them up.

### Delete bindings with incomplete actions

- 1 Click  in the toolbar and choose Select Incomplete Bindings.
- 2 Press the Delete key.

## Triggers

Most of the time Lightkey will simply “capture” triggers when you operate them (e.g. by pressing a button on a MIDI controller) and create a matching binding. You can replace the trigger of an existing binding in the same way.

### Change the trigger of an existing binding

- 1 Do one of the following:
  - ▶ Control-click the binding and choose Capture Trigger... from the menu.
  - ▶ Double-click the trigger in the bindings list.



## 2 Operate the new trigger:

- ▶ **DMX-In:** Operate a fader or button on a DMX console.
- ▶ **MIDI:** Press a button, move a fader, or turn a wheel on a MIDI controller.
- ▶ **Keyboard:** Press a key on the keyboard.

You can also edit the trigger for the selected binding (or bindings) in the area below the bindings list. The left side shows the trigger details, which depend on the selected category.

### DMX-In triggers

- **Trigger:** The type of trigger, either button or fader/knob.
- **Universe:** The DMX universe which Lightkey should observe. Only input universes can be selected. See [Configure universes](#) in chapter 14, [DMX output and input](#) on how to configure universes for DMX input.
- **Channel:** The DMX channel to observe in the universe (1–512).
- **Value** (button-type triggers only): The channel value which triggers the action. Lightkey performs the action whenever the channel assumes this value.
- **Range** (fader-type triggers only): The range of DMX values used by the trigger, often 0 – 255. For example, if the range is 128 – 255 and the action controls a fixture’s intensity, then a DMX value of 128 means 0% intensity and a DMX value of 255 means 100% intensity.
- **Inverted** (fader-type triggers only): Reverses the fader direction.

### MIDI triggers

- **Trigger:** The type of trigger, either button, fader/knob, or wheel.
- **Command:** The MIDI command which triggers the action. Depending on the trigger type, the available commands are Note On/Off, Control Change, Program Change, and Pitch Wheel. The option No Command is used for bindings which send MIDI to another application; see [Send MIDI to other applications](#) later in this chapter for details.
- **Channel:** The MIDI channel through which the message is sent (1–15). (Note: MIDI channel 16 is reserved for use by Live Triggers.)

- **Note** (only Note On/Off commands): The MIDI note to trigger the action. Notes may be displayed by their name, e.g. C#0, or a decimal number. You can enter them in either way. See [MIDI notes](#) later in this chapter.
- **Control** (only Control Change commands): A control number identifying a physical control on your MIDI controller (0–127).
- **Value** (only Control Change commands): The control value which triggers the action (0–127).
- **Program** (only Program Change commands): A MIDI program number which triggers the action (0–127).
- **Sensitivity** (only wheel-type triggers): Determines how quickly the value changes.
- **On/off** (only button-type triggers): Select this for stateful buttons which send a single message when operated (for example, a CC message or alternating Note On/Off messages). In contrast, regular buttons send two messages—one when pressed (e.g. Note On or CC 127) and another (e.g. Note Off or CC 0) when released.
- **14-bit** (only fader-type triggers, Control Change commands): Select this if the fader sends 14-bit (high-resolution) values.
- **Inverted** (only fader- and wheel-type triggers): Reverses the fader or wheel direction.
- **Shift**: The trigger applies only when the MIDI controller's Shift button is held down (see [MIDI Shift button](#) below).
- **Feedback**: The kind of feedback messages sent back to the MIDI controller, e.g. to control LEDs or motorized faders.
  - **None**: Do not send feedback to the MIDI controller.
  - **Default**: The feedback is determined by the connected device. This is the appropriate option in most situations where feedback is being sent to a hardware controller.

The remaining feedback options let you customize the exact MIDI messages sent when the trigger becomes active or inactive. Custom feedback is only available for button-type triggers. It can be used to change the LED colors on MIDI controllers or control other software programs from Lightkey.

- **Note On/Off:** Send a Note On message when the trigger becomes active and a Note Off message when it becomes inactive. You can choose the note and velocity parameters of the Note messages.
- **Note On:** Send a Note On message when the trigger becomes active or inactive. You can choose the note and velocity parameters of the Note On messages.
- **Control Change:** Send a Control Change message when the trigger state changes. You can choose the control and value parameters of each message.
- **Program Change:** Send a Program Change message when the trigger state changes. You can choose the program field of each message.
- **SysEx:** Send a System Exclusive message of arbitrary length when the trigger state changes. You can enter the contents of the messages in hexadecimal form. Each byte must be in the range 0–127 (00–7F).

Click Send to send the MIDI message for testing.

### Keyboard triggers

There are no trigger options for keyboard triggers. To change a keyboard trigger, capture a different trigger as described earlier in this section.

### Actions

The area in the lower-right of the External Control window is where you configure the action for the selected binding (or bindings). The following table shows the different kinds of actions and their parameters. Note that the available actions depend on the trigger type.

Action	Trigger type	What it does	Feedback
Activate/ Deactivate Preset	Button	Activates or deactivates a preset. The Behavior options are described below this table.	✓
Deactivate All Presets	Button	Deactivates all active presets.	—
Start/Stop Sequence	Button	Starts or stops a sequence. The Behavior options are described below this table.	✓
Stop all Sequences	Button	Stops all running sequences.	—
Activate/ Deactivate Cue	Button	Activates or deactivates a cue. The Behavior options are described below this table.	✓
Previous/Next Cue in Fame	Button	Activates the previous or next cue in a frame.	—
Cuelist: Start/ Stop	Button	Starts or stops playback in the a cuelist.	✓
Cuelist: Pause/ Resume	Button	Pauses or resumes playback in a cuelist.	✓
Cuelist: Next Cue	Button	Activates the next cue in a cuelist.	✓
Cuelist: Previous Cue	Button	Activates the previous cue in a cuelist.	—
Cuelist: Xfade	Fader, Wheel	Crossfades to the next cue in a cuelist, as by dragging the Xfade slider.	—
Change Cue Intensity	Fader, Wheel	Changes a cue's intensity, as with a fader in the Live view.	✓
Change Cue Modifier	Fader, Wheel	Changes the value of a cue modifier. If you select "All cues" then the action will affect all cues on the current live page with this modifier.	✓
Reset Cue Modifier	Button	Sets the value of a cue modifier to either its default or neutral value.  If you select "All cues" then the action will affect all cues on the current live page with this modifier.	✓
Change Frame Modifier	Fader, Wheel	Changes the value of a frame modifier.	✓
Reset Frame Modifier	Button	Sets the value of a frame modifier to either its default or neutral value.	✓

Action	Trigger type	What it does	Feedback
Deactivate Cues in Frame	Button	Deactivates all cues in a frame.	—
Deactivate All Cues	Button	Deactivates all active cues.	—
Select Live Page	Button	Selects a Live view page. You can choose to select: <ul style="list-style-type: none"> <li>• The previous or next page (in the order in which they appear in the menu);</li> <li>• A particular page.</li> </ul>	✓
Select Fixtures	Button	Selects one or more fixtures. You can choose to select: <ul style="list-style-type: none"> <li>• All or no fixtures;</li> <li>• The previous or next fixture (by short name);</li> <li>• A particular fixture (if the fixture is in a group you can optionally select the entire group);</li> <li>• All fixtures with a particular profile.</li> </ul>	—
Change Fixture Property	Button/ Fader, Wheel	Changes a fixture property, as in the Design view or the HUDs. The available options depend on the selected property. You can choose if the changes should affect the selected fixture(s) or a particular fixture or set of fixtures.	For most fixture properties
Clear Properties	Button	Clears the overridden fixture properties.	—
Blind Mode	Button	Enables or disables blind mode.	✓
Freeze Output	Button	Freezes or unfreezes the output.	✓
Master Dimmer	Fader, Wheel	Controls the Master Dimmer, as by dragging the Master Dimmer slider in the Live view.	✓
Tap Beat	Button	Sets the beat grid by tapping four times, as with the beat controls in the Live view.	✓
Sync Beat	Button	Synchronizes the time of the next beat, keep the tempo.	✓
Sync Downbeat	Button	Synchronizes the time of the first beat, keep the tempo.	✓
Set Beat	Fader, Wheel	Adjusts the tempo (beats per minute) with a fader. You can choose the values which correspond to the minimum and maximum fader positions.	✓

Action	Trigger type	What it does	Feedback
Halve Beat	Button	Halves the current tempo (beats per minute).	—
Double Beat	Button	Doubles the current tempo (beats per minute).	—
Select Configuration	Button	Selects an external control configuration. You can choose to select: <ul style="list-style-type: none"> <li>The previous or next configuration (in the order in which they appear in the menu);</li> <li>A particular configuration.</li> </ul>	✓
Shift	Button	Designates the trigger as the Shift button. See <a href="#">MIDI Shift button</a> below.	—

Actions for activating a presets, sequences, and cues let you specify their exact behavior:

- **Toggle:** Toggle the “active” state whenever the trigger’s state changes to on—for example, when a button on a MIDI controller or a key on the keyboard is pressed.
- **Flash:** Activate the object when the trigger’s state is on, for example, when a button or key is pressed. Deactivate the object when the trigger’s state is off, for example, when a button or key is released.
- **Activate:** Activate the object when the trigger’s state is on.
- **Deactivate:** Deactivate the object when the trigger’s state is on.

Choose Set as Default to use the selected behavior for all new bindings you create in the External Control window.

After configuring an action, you can test it to see its effect.

### Test an action

- ▶ To test an action with a button trigger, click Run.
- ▶ To test an action with a fader or wheel trigger, drag the Test slider.

★ **Tip:** If a message sent to Lightkey doesn’t have the intended effect, you can use the External Control Log to track down the problem. See [External Control Log](#) later in this chapter.

## MIDI Shift button

Some MIDI controllers have a Shift button which works similarly to the Shift key on a keyboard: When you hold down Shift and operate another button, fader, or wheel, the other control performs a different action. Even if your controller has no button with a Shift label, you can designate any button as the Shift button.

Before you can create triggers with Shift you need to tell Lightkey which button is the Shift button.

### Designate a button as the Shift button

- 1 In the External Control window, click MIDI.
- 2 In the Input pop-up menu, select the input which corresponds to your MIDI controller.
- 3 Press the Shift button on your MIDI controller.  
A new binding appears whose trigger matches the pressed button.
- 4 Choose Shift as the binding's action.

## MIDI notes

You can choose whether Lightkey should display MIDI note values as musical notes (C-2 through G8, middle C is C3) or decimal numbers (0 through 127).

### Change how MIDI notes are displayed

- 1 Choose Lightkey → Settings... and then click External Control.
- 2 Select an option next to "Show MIDI notes as".

In fields where you enter MIDI notes (in the External Control window) you can always use both notations.

## Live Triggers

Ableton Live is a music sequencer and digital audio workstation (DAW) software used by many musicians and DJs. **Live Triggers** are a quick and convenient way to trigger lighting cues directly from the Ableton Live timeline, perfectly synchronized to the music. This enables live performers to run a fully automated light show without the need for manual operation.

This section assumes that you are familiar with the basics of Ableton Live and already have a Lightkey project with cues that will be triggered from Ableton Live. Lightkey and Ableton Live need to run on the same computer.

It is up to you how you organize your cues. For example, can use a cuelist for each song and step through the cues one by one. Or you can use cue buttons and activate one or multiple cues at various points in the timeline. For more information on buttons, cuelists, and cues, see chapter 11, [Live control](#).

### Set up communication between Ableton Live and Lightkey

- 1 In Lightkey, choose Lightkey → Settings..., click External Control, and make sure Enable Live Triggers is selected.
- 2 In Ableton Live, choose Live → Settings... and then click Link MIDI.
- 3 Locate the row “Output: Lightkey Input” in the MIDI Ports list (this row is only visible when Lightkey is open).
- 4 Make sure the button in the Track column reads “On”.

After setting up the communication, you’ll add one or more MIDI tracks to your set from which you’ll control your lighting cues. (To activate more than one cue at a time, it is necessary to use multiple tracks.)

### Add a MIDI track to your project

- 1 In Ableton Live, go to Arrangement View.
- 2 Choose Create → Insert MIDI Track.
- 3 Make sure the In/Out section is visible (choose View → In/Out), then configure the options in the track’s In/Out section:

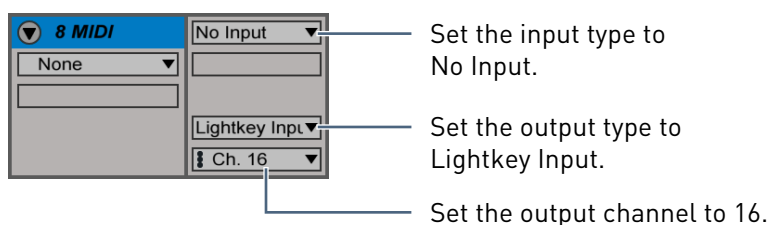

Now you’re ready to add lighting cues to your Ableton Live set. You’ll do that by dragging prepared MIDI clips to the MIDI track.



## Add clips to a MIDI track

- 1 Make sure that Ableton Live's browser is visible (choose View → Show Browser).
- 2 Locate and expand the item User Library → Lightkey in the browser.
- 3 Expand the item for the current Lightkey project. It contains the following groups:
  - Actions: This contains clips for generic actions.
  - One group for each Live view page: These groups contain clips for every cue on the page. There's also a clip which selects the page in Lightkey's Live view.

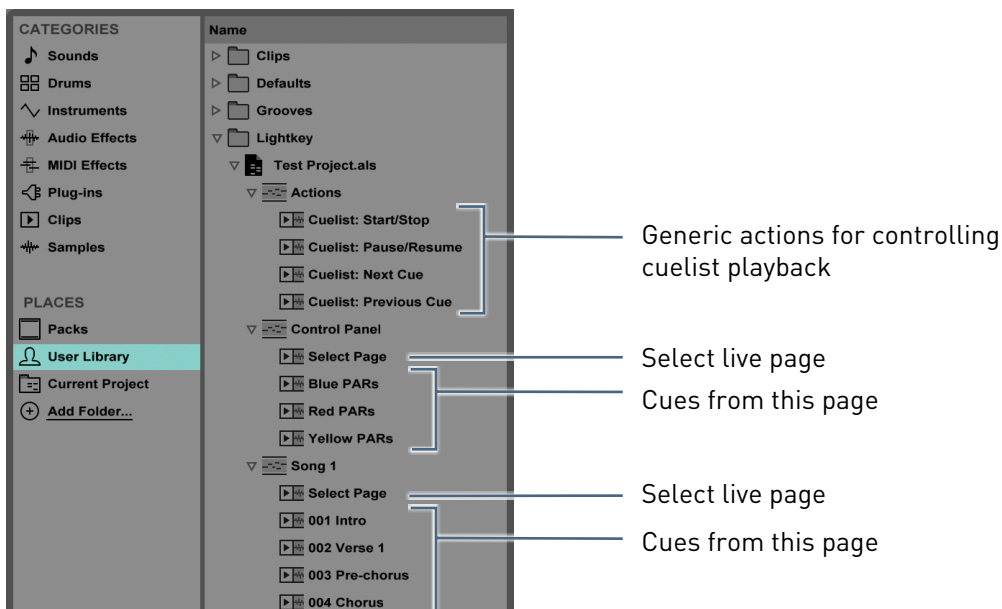

- 4 Drag clips to the MIDI track.
- 5 Drag the right edge of the clips to adjust their duration, if necessary:
  - Cues with a button: The cue is activated at the beginning of the clip and remains active for its entire duration. Adjust the clip's duration to the time you would like the cue to stay active.
  - Cues in a cueList: The cue is activated at the beginning of the clip and remains active until another cue is activated. You don't need to adjust the clip's duration.
  - Other clips: The action is performed at the beginning of the clip. You don't need to adjust the clip's duration.

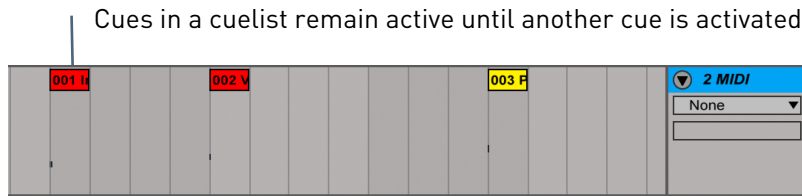
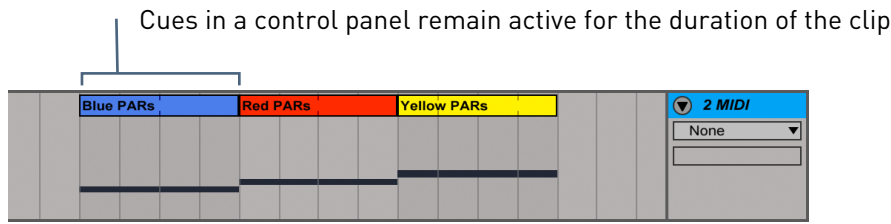

- 6 Play back the set. When playback reaches the beginning of a clip, the corresponding cue activates in Lightkey.

For cues with a button, a clip's duration determines how long the corresponding cue remains active. You can activate multiple cues at once by adding more MIDI tracks.

➤ **Important:** Version 11.1 of Ableton Live has started to change the input and output type of empty MIDI tracks when you drag a clip to it. You will therefore need to restore those settings after adding the first MIDI clip.

➤ **Important:** Always drag the right end of a clip to change its duration, never the left end. (At the beginning of a clip a MIDI message is sent to Lightkey which activates the cue. When you drag the left end of a clip then either that message is sent too late or no message is sent.)



If you accidentally dragged the left end of a clip, you can fix it as follows:

### Fix a clip whose cue doesn't activate correctly

- 1 Double-click the clip. The MIDI Note Editor appears in the Details view.

- 2 Drag the Start Marker in the MIDI Note Editor to the very left.

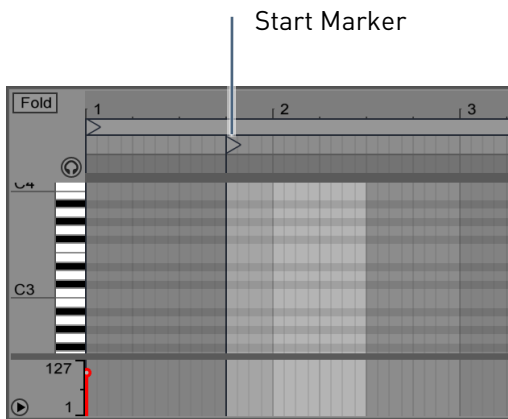

When you use a cuelist, you can either use the clip “Cuelist: Next Cue” to step through the cues sequentially, or you can jump to a specific cue by dragging a cue to the timeline.

The “Select Page” clips can be used to explicitly switch to a Live view page. Usually this isn’t necessary: Lightkey automatically switches to the respective page when a cue is activated.

## Behind the scenes

Live Triggers work through MIDI messages. Lightkey sets up a number of external control bindings which bind MIDI messages to actions like activating a cue. It then creates a MIDI clip in Ableton Live for each binding.

To view these bindings, choose Window → External Control, click MIDI, and select Live Triggers from the Configuration pop-up menu. This special configuration is managed by Lightkey and can’t be edited. If you keep the External Control window open you will see that bindings are selected when a matching MIDI message arrives.

The bindings for activating cues use “Note On” MIDI messages. Since there are 128 MIDI “notes”, Lightkey can create up to 128 cue bindings per Live view page.

MIDI messages for Live Triggers are always sent on MIDI channel 16. This channel is reserved for messages between Ableton Live and Lightkey, you cannot use it for your own MIDI bindings.

## Disable Live Triggers

By default Lightkey creates Live Trigger bindings for all cues in every project and makes them available to Ableton Live. You can exclude individual cues from Live Triggers, which can be useful to keep the list of clips short, especially if you're approaching the 128 cues limit. You can also disable Live Triggers completely if you don't use it.

### Exclude a cue from Live Triggers

- 1 Open the cue inspector, as described in [Edit cue contents and options](#) in chapter 11, [Live control](#).
- 2 Scroll to "Live Triggers".
- 3 Select "Exclude from Live Triggers".

### Disable Live Triggers

- 1 Choose Lightkey → Settings... and then click External Control.
- 2 Deselect the option "Enable Live Triggers". This disables Live Triggers for all projects.

## Troubleshooting

Here are some helpful tips if Live Triggers don't work as expected:

- **If your Lightkey project doesn't appear in Ableton Live's browser:** Make sure Live Triggers are enabled in Lightkey's Settings window. See [Disable Live Triggers](#) previously in this section.
- **If a change in Lightkey doesn't show in Ableton Live's browser:** Select the Live Triggers configuration in the MIDI tab of the External Control window and click Update. Also make sure not to exceed the limit of 128 cues per Live view page.
- **If Lightkey shows no response to triggers:** Check if the MIDI track has the correct input, output, and channel settings, as described earlier in this section. Use the External Control Log to verify that Lightkey receives the message. See [External Control Log](#) later in this chapter.
- **If a single clip doesn't activate its cue, or if the cue activates too late:** You may have accidentally dragged the left edge of the clip. This can be fixed in the MIDI Note Editor for the clip, as described earlier in this section.

## Trigger actions from ProPresenter

ProPresenter is a presentation software especially popular among houses of worship. The following example shows how to trigger cues and other actions in Lightkey from ProPresenter 17 through MIDI messages. The example assumes that Lightkey and ProPresenter run on the same computer.

### Set up communication from ProPresenter to Lightkey

- 1 Make sure that Lightkey is open.
- 2 In ProPresenter, open the Settings window and click Devices.
- 3 Click Add Device and choose MIDI from the pop-up menu.
- 4 In the next screen, make the following changes:

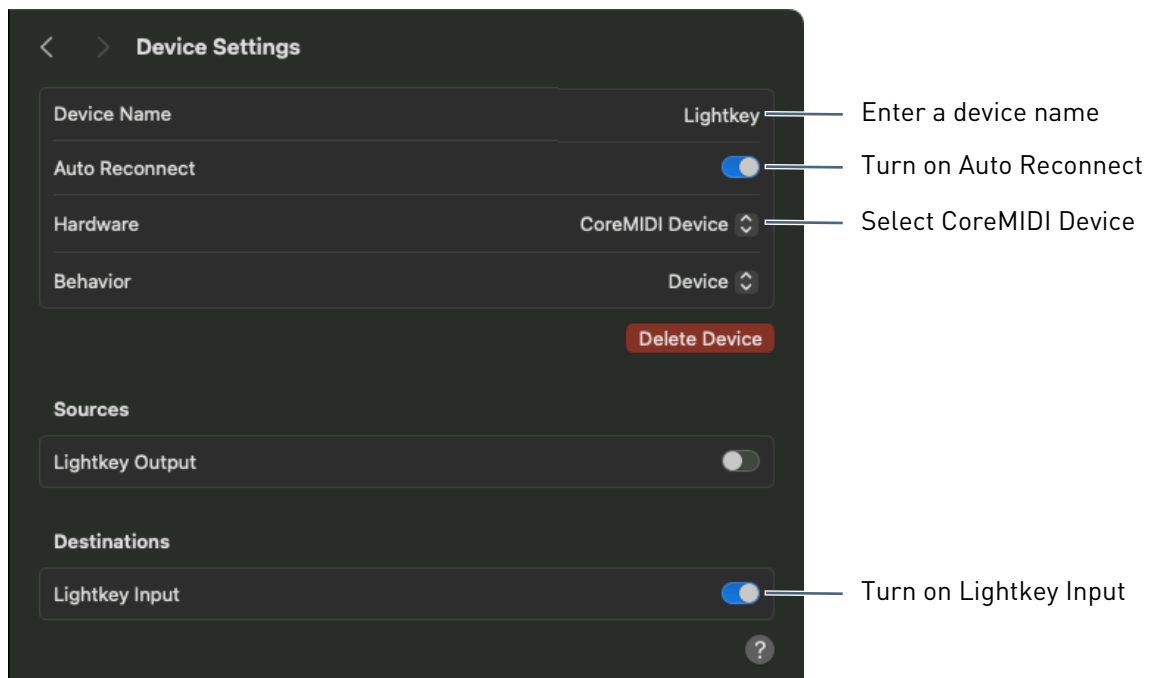

- 5 Click < in the upper-left corner.

A new item appears in the list.

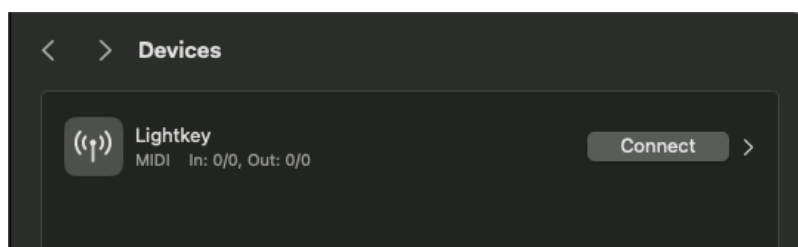

- 6 Click Connect.

After MIDI communication has been established you can set up actions in Lightkey—for example, activating a cue—to be performed when a certain slide is shown.

### Trigger an action in Lightkey when a ProPresenter slide appears

- 1 Control-click a slide in ProPresenter and choose Add Action → Communication → Lightkey → MIDI Note On. (Here, “Lightkey” is the name of the connection.)
- 2 In the window that appears, make the following changes:

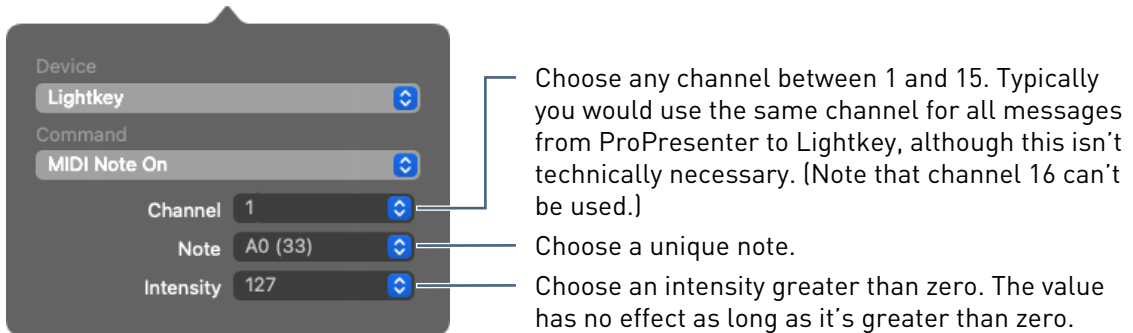

- 3 Click Done.

Note the icon in the top-left corner of the slide's preview, indicating that a MIDI message is associated with the slide.

- 4 In Lightkey, choose Window → External Control and click MIDI.
- 5 In the Input pop-up menu, select Lightkey Input.
- 6 Click + in the toolbar.

A new MIDI binding is added to the list.

- 7 Edit the binding in the area below the bindings list:
  - ▶ In the Channel and Note fields on the left, enter the same channel and note values as in ProPresenter.
  - ▶ In the right part, select an action and set its parameters. To activate a cue, select Activate/Deactivate Cue, then select a cue and set the behavior to Activate.

When you run your ProPresenter presentation and a slide with a MIDI message appears, the corresponding action is triggered in Lightkey. If that doesn't work you can use the External Control Log to track down the error. For more information see [External Control Log](#) later in this chapter.

❖ **Note:** It is also possible to do the reverse—have ProPresenter automatically go to a slide when you activate a cue in Lightkey. For details see the following section, [Send MIDI to other applications](#).

## Send MIDI to other applications

Although the primary purpose of the external control system is to control Lightkey from external sources, you can also use it to send MIDI messages to other applications such as QLab or ProPresenter. Here's an example how to make Lightkey send a MIDI message each time a certain cue is activated or deactivated.

### Send MIDI messages to another application

- 1 Open Lightkey and the application you would like to send MIDI messages to.
- 2 Configure the target application to receive MIDI messages from the Lightkey Output port.
- 3 In Lightkey, open the External Control window and click MIDI.
- 4 In the Input pop-up menu, select Lightkey Input, which represents Lightkey's own MIDI port. Feedback messages for this port are sent to Lightkey Output.
- 5 Click + in the toolbar.

A new MIDI binding is added to the list.

- 6 Configure the trigger in the lower-left part of the window:
  - **Trigger:** Select Button.
  - **Command:** Select No Command, which indicates that the binding doesn't respond to input and is used exclusively for sending messages.
  - **Feedback:** Select the type of MIDI message you would like to send, for example, Note On/Off.
  - Use the following fields to configure the messages sent when the cue becomes active and inactive.
  - You can click Send to send a test message.
- 7 Configure the action in the lower-right part of the window:
  - **Action:** Select Activate/Deactivate Cue.
  - **Cue:** Select a cue.

- 8 To test the binding, click Run or activate the cue in the Live view. A MIDI message is sent to the target application.

★ **Tip:** To review the messages Lightkey is sending to other apps you can use the External Control Log. See [External Control Log](#) later in this chapter.

## MIDI routing

Lightkey automatically recognizes connected MIDI hardware as well as source and destination ports from other applications on your computer. You can choose which ports should be used for input and output.

### Select the MIDI ports used for external control

- 1 Choose Lightkey → Settings... and then click External Control.
- 2 Enable or disable inputs and outputs as necessary.

For MIDI bindings associated with a particular input, Lightkey sends feedback messages to the corresponding output. In some situations it may be necessary to tell Lightkey which MIDI output belongs to a particular input.

### Select the MIDI output which belongs to a particular input

- 1 Choose Lightkey → Settings... and then click External Control.
- 2 Control-click a MIDI input and choose Send Feedback To from the menu, then choose a MIDI output.

To receive MIDI messages from other software, Lightkey creates a MIDI port named Lightkey Input. You can select this port as a destination in other MIDI-capable apps when Lightkey is open. This eliminates the need to use a virtual MIDI bus (like the IAC Driver) to send MIDI between apps. Feedback for bindings in Lightkey Input is sent to the Lightkey Output port.



## Open Sound Control (OSC)

OSC (Open Sound Control) is a communication protocol for sending short messages over a computer network. Any software that can send arbitrary OSC messages can be used to control Lightkey. Popular OSC-capable Mac and iOS applications include QLab, TouchOSC, Lemur, and Vezér.

Each OSC-controllable element in Lightkey has an address. This means you don't need to bind elements to triggers first, like with MIDI or DMX. OSC messages follow a logical structure and are much easier to read than MIDI or DMX. For example, here's a message to activate a particular cue in the Live view:

```
/live/My_Live_Page/cue/Ballyhoo/activate
```

## Connect to Lightkey

Lightkey receives incoming OSC messages through UDP and TCP over a local network. Senders can use Bonjour to easily connect to Lightkey.

### Connect to Lightkey from another application

- 1 In Lightkey, choose Lightkey → Settings..., then click External Control and make sure Enable OSC is selected.
- 2 If the sender application runs on a different computer, make sure it's connected to the same local network.
- 3 If the other application is on the same computer:
  - ▶ Set the destination address to "localhost" or "127.0.0.1", and set the destination port to 21600.

If the other application supports Bonjour:

- ▶ Select Lightkey in the OSC settings of the sender application.

If the other application does not support Bonjour:

- ▶ In the sender application's OSC settings, enter the IP address of the computer where Lightkey runs (you can find this number in the Network pane of System Settings) and set the port number to 21600.

## OSC addresses

An OSC message consists of an **address** followed by zero or more **arguments**. The address always starts with a / and is followed by one or more /-separated **parts**.

An address selects a **method** in Lightkey, which is the equivalent of performing an action. The following section describes all OSC methods that Lightkey understands.

Objects like cues, presets, and fixtures are addressed by their name. When you write the name in OSC, keep the following in mind:

- OSC addresses are case-sensitive, so use uppercase and lowercase letters exactly as in the original name.
- OSC addresses must not contain spaces, so you need to use an underscore instead. For a cue named “Front Lights On”, you would type `Front_Lights_On` in OSC.
- There are a number of other characters which are forbidden in OSC address parts, so it’s best to avoid them in cue names. Address parts may only contain printable 7-bit ASCII characters except for the following: `#* , / ? [ ] { }`

If you must use one of these characters in your object names, you can use address patterns to match them, as explained below.

Lightkey supports OSC **address patterns** to match the names of objects like cues and presets. The syntax for patterns is as follows:

- `?` matches any single character.
- `*` matches zero or more characters.
- A string of characters in square brackets matches any character in the string. For example, `Fab_[46]` matches “Fab 4” and “Fab 6”.
- Two characters in square brackets with a minus sign in between indicate the range of characters between the given two, in ASCII order. For example, `Fab_[4-6]` matches “Fab 4,” “Fab 5,” and “Fab 6.”
- An exclamation point at the beginning of a bracketed string negates the sense of the list, so the list matches any character not in the list.
- A comma-separated list of strings enclosed in curly braces matches any of the strings in the list. For example, `Fab_{Four,Six}` matches “Fab Four” and “Fab Six”.

Lightkey provides a quick and convenient way to copy of the OSC address of many elements in the user interface. For example, this works for cues in the Live view and many buttons and sliders in the Design view.

### Quickly copy the OSC address of an element

- ▶ Control-click an element in the user interface (e.g. a button or slider) and choose External Control → Copy OSC Address from the shortcut menu. This command is only available for elements whose action can be performed through OSC.

## Live view

All elements of the Live view—like cues, frames, and modifiers—can be fully controlled through OSC.

**`/live/pageName/select [fadeTime]`**

Use this method to select the Live view page with the name *pageName*. The optional *fadeTime* argument lets you specify a custom fade time, in seconds, which overrides the page's fade time.

**`/live/pageName/cue/cueName/activate [fadeTime]`**

**`/live/pageName/cue/cueName/deactivate [fadeTime]`**

**`/live/pageName/cue/cueName/toggle [fadeTime]`**

These methods let you activate or deactivate cues. *pageName* is the name of a Live view page; you can also use the keyword `selected` to address the currently selected page. *cueName* is the name of a cue or a pattern matching multiple cue names; you can also use `active` for all active cues. It's possible to activate cues on pages other than the selected one, but this has no effect until the page is selected.

The optional *fadeTime* argument lets you specify a custom fade time, in seconds, which overrides the cue's fade time. If you use this argument the Fade Time modifier is ignored.

Remember that names are case-sensitive and you must replace spaces with underscores. You can use wildcards to match multiple cues.

Here are some examples:

- `/live/Main_Page/cue/Red_Backlight/activate`  
Activates the cue “Red Backlight” on the page “Main Page”.
- `/live/selected/cue/Red_Backlight/activate`  
Activates the cue “Red Backlight” on the currently selected page.
- `/live/*/cue/Red_Backlight/activate 0.5`  
Activates the cue “Red Backlight” on all pages with a fade time of 0.5 seconds.
- `/live/*/cue/071*/activate`  
Activates cue number 071 in a cuelist.
- `/live/*/cue/*/deactivate 0`  
Deactivates all cues on all pages with no fade.

**`/live/pageName/cue/cueName/intensity value`**

This method controls the intensity of fader buttons in the Live view. *value* is a number between 0 and 1.

**`/live/pageName/frame/frameName/cue/cueName/...`**

This is an alternative way to address cue buttons within a frame. You can append any command for cues, like `toggle`. For example, this message deactivates all cues in the frame named “Backlight”:

- `/live/selected/frame/Backlight/cue/*/deactivate`

The following method changes the intensity of the active cues inside the frame:

- `/live/selected/frame/Backlight/cue/active/intensity 0.8`

**`/live/pageName/frame/frameName/previousCue [fadeTime]`**

**`/live/pageName/frame/frameName/nextCue [fadeTime]`**

These methods activate the previous or next cue in a frame, respectively. The optional *fadeTime* argument lets you specify a custom fade time, in seconds.

**`/live/cueListName[/groupName1[/groupName2[...]]/cueName/...`**

In a cue list, you can also address cues through their enclosing groups. Replace *groupName1*, *groupName2* and so on with the names of the groups containing the cue, or a pattern matching those names. You can append any command for cues, like `activate`. For example:

- `/live/selected/Song_1/001_Intro/activate`

**`/live/pageName[/frame/frameName]/cue/cueName/modifier value`**

**`/live/pageName/frame/frameName/modifier value`**

These methods give you control over cue and frame modifiers. *modifier* is one of the following:

speed	beatMultiplier	timeOffset	fadeTime
dimmer	hue	colorTemperature	greenSaturation
xfadeToColor	panAngle	tiltAngle	focus
zoomAngle	irisSize	frostAmount	fogAmount

*value* is the value for the modifier. For percent values, use a number where 0.0 maps to 0% and 1.0 maps to 100%. You can also use `neutral` or `default` to reset a modifier to its neutral or default value, respectively. Here are some examples:

- `/live/selected/cue/Waterfall/speed 1.2`
- `/live/selected/cue/Waterfall/beatMultiplier /6`
- `/live/selected/cue/Waterfall/beatMultiplier x12`
- `/live/selected/cue/*/fadeTime 0`
- `/live/selected/cue/*/dimmer neutral`
- `/live/selected/cue/active/colorTemperature 5600`
- `/live/selected/cue/active/hue 180`
- `/live/selected/frame/Movers/panAngle -30`
- `/live/selected/frame/Movers/tiltAngle default`
- `/live/selected/frame/Movers/cue/active/focus 1.3`

```
/live/start  
/live/stop  
/live/toggle  
/live/pause  
/live/resume  
/live/togglePaused  
/live/nextCue [fadeTime]  
/live/previousCue [fadeTime]
```

These methods control cue list playback. They are only available if a cue list is selected.

The optional *fadeTime* argument lets you specify a custom fade time, in seconds, which overrides the cue's fade time.

```
/live/xfade level
```

Use this method to control manual crossfades in a cue list. *level* is the level of the Xfade slider, a number between 0 and 1.

```
/live/cueListName/cue/cueName/skip  
/live/cueListName/cue/cueName/unskip
```

These methods change the checkmarks to the left of the cues' names in a cue list.

## Preset Palette

You can activate or deactivate presets, and start or stop sequences, with OSC messages. Because the Preset Palette often contains multiple items with the same name, addresses include the names of the enclosing groups, for example:

```
/palette/Movers/Colors/Indigo
```

You can replace the names of groups, presets, and sequences with address patterns, as described earlier in this section. For example, this addresses all presets named "Indigo" that are nested in two groups:

```
/palette/**/Indigo
```

What if you want to address all presets named “Indigo” in any group? In this case you use the // operator, which looks in all descendant items of the group to its left. For example:

- `/palette/Movers//Indigo`  
Addresses any item in “Movers”—including contained groups—named “Indigo”.
- `/palette//Indigo`  
Addresses any item named “Indigo”.
- `/palette/Movers//`  
Addresses all items in the “Movers” group and contained groups.

**`/palette/address/of/preset/activate`**

**`/palette/address/of/preset/deactivate`**

**`/palette/address/of/preset/toggle`**

These methods activate or deactivate a preset. Replace *address/of/preset* with the address of one or more presets, as described above.

**`/palette/address/of/sequence/start`**

**`/palette/address/of/sequence/stop`**

**`/palette/address/of/sequence/toggle`**

These methods start or stop a sequence. Replace *address/of/sequence* with the address of one or more sequences, as described above.

## Output control

The following methods control the global DMX output.

**`/output/enterBlind`**

**`/output/exitBlind`**

**`/output/cancelBlind`**

**`/output/toggleBlind`**

These methods enter and exit blind mode.

**/output/freeze**  
**/output/unfreeze**  
**/output/toggleFreeze**

These methods freeze or unfreeze DMX output.

**/output/master *value***

This method sets the Master Dimmer level. *value* is a number between 0 and 1.

## Beat control

The following methods control beat synchronization.

**/beat/tap**

Set the beat grid by sending this message four times on successive beats.

**/beat/sync**

Synchronizes the time of the next beat while keeping the tempo.

**/beat/syncDownbeat**

Synchronizes the time of the first beat while keeping the tempo.

**/beat/halve**

**/beat/double**

Halves or doubles the current tempo (beats per minute).

**/beat/tempo *bpm***

Specifies the tempo. *bpm* is a number which signifies the beats per minute.

## Fixture properties

You can control the properties of individual fixtures through OSC, like in the Design view. The complete set of fixture properties is exposed through OSC. (It's not currently possible to control individual light beams through OSC, though.)



**`/fixture/fixtureName/overrides/propertyName value`**

Use this method to set fixture properties. *fixtureName* is the short name of a fixture or a pattern matching multiple fixture names; you can use `selected` to address the currently selected fixtures. Choose *propertyName* and *value* according to the following table:

Property name	Value
<code>on</code>	on or off
<code>dimmer</code>	A number between 0 and 1.
<code>color{1 2 3}</code>	The index of a color on a color wheel.
<code>rainbowSpeed{1 2 3}</code>	A nonnegative number (revolutions per second).
<code>color</code>	Three numbers between 0 and 1 corresponding to red, green, and blue. Alternatively, a string specifying RGB values in hexadecimal form (make sure the argument is sent as a string, not an integer).
<code>hue, saturation, brightness</code>	A number between 0 and 1.
<code>warmWhite, coolWhite, amber, lime, ultraviolet</code>	A number between 0 and 1.
<code>colorTemperature</code>	A color temperature in Kelvin.
<code>greenSaturation</code>	A number between -1 and +1.
<code>xfadeToColor</code>	A number between 0 and 1.
<code>panAngle, tiltAngle</code>	A positive or negative angle in degrees.
<code>infinitePanMode, infiniteTiltMode</code>	One of the following: <code>stopped</code> , <code>rotatingCW</code> , <code>rotatingCCW</code>
<code>infinitePanSpeed, infiniteTiltSpeed</code>	A nonnegative number (revolutions per second).
<code>speedMode</code>	One of the following: <code>tracking</code> , <code>trackingSlow</code> , <code>trackingMedium</code> , <code>trackingFast</code> , <code>vector</code> , <code>blackoutDuringPanTiltMovement</code> , <code>blackoutDuringWheelMovement</code> , <code>blackoutDuringAnyMovement</code>
<code>vectorSpeed</code>	A number between 0 and 1.
<code>gobo{1 2 3}</code>	The index of a gobo on a gobo wheel.
<code>goboRotationMode{1 2 3}</code>	One of the following: <code>stopped</code> , <code>rotatingCW</code> , <code>rotatingCCW</code> , <code>bouncing</code> , <code>indexed</code>

Property name	Value
<code>goboShakeMode{1 2 3}</code>	One of the following: <code>stopped</code> , <code>shaking</code>
<code>goboRotationSpeed{1 2 3}</code>	A nonnegative number (revolutions per second).
<code>goboAngle{1 2 3}</code>	An angle in degrees.
<code>goboShakeSpeed{1 2 3}</code>	A nonnegative number in Hz.
<code>goboCycleSpeed{1 2 3}</code>	A nonnegative number (revolutions per second).
<code>shutterState</code>	One of the following: <code>closed</code> , <code>open</code> , <code>strobe</code> , <code>syncStrobe</code> , <code>randomStrobe</code> , <code>randomSyncStrobe</code> , <code>lightningStrobe</code> , <code>pulseOpening</code> , <code>pulseClosing</code> , <code>pulseAlternating</code> , <code>burstPulse</code> , <code>randomPulseOpening</code> , <code>randomPulseClosing</code> , <code>randomPulseAlternating</code> , <code>randomPurstPulse</code>
<code>strobeSpeed</code>	For steady strobing: A value in Hz. For random strobing: A number between 0 and 1.
<code>shutterPulseSpeed</code>	For steady pulsing: A value in Hz. For random pulsing: A number between 0 and 1.
<code>prismType{1 2}</code>	One of the following: <code>none</code> , <code>twoFacet</code> , <code>threeFacet</code> , <code>fourFacet</code> , <code>fiveFacet</code> , <code>sixFacet</code> , <code>eightFacet</code> , <code>sixteenFacet</code> , <code>fiveFacetCenter</code> , <code>threeFacetLinear</code> , <code>fourFacetLinear</code> , <code>fiveFacetLinear</code> , <code>sixFacetLinear</code> , <code>frost</code>
<code>prismRotationMode{1 2}</code>	One of the following: <code>stopped</code> , <code>rotatingCW</code> , <code>rotatingCCW</code> , <code>indexed</code>
<code>prismRotationSpeed{1 2}</code>	A nonnegative number (revolutions per second).
<code>prismAngle{1 2}</code>	An angle in degrees.
<code>focus</code>	A number between 0 and 1.
<code>zoomAngle</code>	A zoom angle in degrees.
<code>irisSize</code>	A number between 0 and 1.
<code>frostState</code>	One of the following: <code>off</code> , <code>on</code> , <code>linear</code> , <code>pulseIncreasing</code> , <code>pulseDecreasing</code>
<code>frostAmount</code>	A number between 0 and 1.
<code>frostPulseSpeed</code>	A value in Hz.
<code>fogAmount</code>	A number between 0 and 1.

Here are some examples:

- `/fixture/F4/overrides/dimmer 1.0`
- `/fixture/F4/overrides/color1 5`
- `/fixture/F4/overrides/color 0.29 0.0 0.51`
- `/fixture/F4/overrides/color "4b0082"`
- `/fixture/F4/overrides/hue 0.87`
- `/fixture/F4/overrides/amber 0.25`
- `/fixture/F4/overrides/colorTemperature 5600`
- `/fixture/F4/overrides/greenSaturation -0.2`
- `/fixture/F4/overrides/xfadeToColor 1`
- `/fixture/F4/overrides/shutterState strobe`
- `/fixture/F4/overrides/strobeSpeed 2.4`
- `/fixture/F4/overrides/panAngle 45`
- `/fixture/F4/overrides/focus 0.15`
- `/fixture/F4/overrides/zoomAngle 40`
- `/fixture/F4/overrides/irisSize 0.9`

Beyond that you can also control any custom fixture properties specific to the fixture. Use the property's name as it appears in the Design view, but replace spaces with underscores. For properties with a list of options, replace *value* is the name of the option, for example:

- `/fixture/F6/overrides/Auto_Program Program_1`

For properties with a slider, specify the slider value—either a number between 0 and 1 for percentage sliders, or a number between 0 and 255 if the slider shows a DMX value:

- `/fixture/F6/overrides/Auto_Program_Speed 0.7`
- `/fixture/F6/overrides/Pattern 255`

If a property has both options and a slider, use two arguments:

- `/fixture/F6/overrides/Effect Effect_7 0.15`

**/fixture/*fixtureName*/overrides/clear**

**/fixture/*fixtureName*/overrides/*propertyName*/clear**

The first method clears all overridden properties for one or more fixtures, the second clears a single overridden property. *fixtureName* is the short name of a fixture or a pattern matching multiple fixture names; you can use `selected` to address the currently selected fixtures. *propertyName* is one of the following fixture property names:

dimmer	colorWheel{1 2 3}	color
position	speed	goboWheel{1 2 3}
shutter	prismWheel{1 2}	focus
zoom	iris	frost
fog		

*propertyName* can also be the name of a custom (fixture-specific) property.

Here are some examples:

- `/fixture/F4/overrides/clear`  
Clears all overrides for the fixture F4.
- `/fixture/*/overrides/shutter/clear`  
Clears the Shutter property for all fixtures.

**/fixture/*fixtureName*/lamp/on**

**/fixture/*fixtureName*/lamp/off**

These methods send a Lamp On or Lamp Off signal to one or more fixtures which support this.

**/fixture/*fixtureName*/command/*commandName***

This sends a command to one or more fixtures. *commandName* is the name of a command understood by the fixture, e.g. Reset.

**`/fixture/fixtureName/select`**

**`/fixture/fixtureName/deselect`**

These methods select or deselect one or more fixtures. *fixtureName* is the short name of a fixture or a pattern matching multiple fixtures.

★ **Tip:** If an OSC message doesn't have the intended effect, you can use the External Control Log to track down the problem. See [External Control Log](#) later in this chapter.

## External Control Log





The External Control Log shows all DMX-In, MIDI, and OSC messages received by Lightkey, as well as feedback sent to MIDI controllers. It also shows what effect an input had and if errors occurred. This makes it a useful tool for tracking down issues with external control.

### Open the External Control Log

- ▶ Choose Window → External Control Log (or press Command-Option-Shift-E). In the window that appears, click either DMX-In, MIDI, or OSC.

Each row in the log corresponds to a message received or sent by Lightkey. Rows include a timestamp and a comment indicating which effect an input had or which binding a feedback message originated from. Click the arrow next to a comment to view the corresponding binding in the External Control window.

### Work with the External Control log

- ▶ To pause logging new messages, click . Click  to resume.
- ▶ To insert a marker, click .
- ▶ To clear previously logged messages, click .
- ▶ To filter the log, type one or more words in the search field. Only entries that contain your search text will be shown.
- ▶ To copy the selected log items to the Clipboard, choose Edit → Copy.

❖ **Note:** The log only tracks messages that arrive while its window is open (and logging isn't paused). It stores up to 1000 messages; after that, the oldest messages are discarded.

## macOS shortcuts

Starting with macOS Monterey you can control Lightkey using the system-wide shortcuts feature. Lightkey provides numerous actions, primarily for live control, which are available in the Shortcuts app. You can also run shortcuts from Siri.

You create and edit shortcuts in the Shortcuts app that comes with macOS. For more information see the Shortcuts User Guide by Apple.

You can also quickly create shortcuts from within Lightkey. These shortcuts will subsequently appear in the Shortcuts app and you can edit them there.

### Create a shortcut from Lightkey

- 1 Control-click an element in the user interface and choose External Control → Add Shortcut... from the shortcut menu. This command is only available for some elements, e.g. Live view buttons or cues in a cuelist.
- 2 In the window that opens, enter a phrase which can be used to invoke the shortcut from Siri, then press Return. (This is necessary even if you don't want to use Siri.) The phrase is also used as the shortcut's title.
- 3 Click Edit in Shortcuts to view and further edit the shortcut in the Shortcuts app.

➤ **Important:** Make sure to open Lightkey before you run or edit a shortcut with actions from Lightkey in Shortcuts. If Lightkey isn't open, Shortcuts launches an invisible copy of Lightkey. Since it's invisible you cannot quit this copy.

The following table lists the shortcut actions provided by Lightkey.

Action	What it does
<b>Activate/Deactivate Cue</b>	<p>Activates or deactivates one or more cues. If the cues are on a different Live page than the current one, they won't become active until you switch to that page.</p> <p>You can choose one or more fixed cues to (de-)activate, or use the output of a preceding action like Find Cues or Get Active Cues, or use a variable containing one or more cues.</p> <p>You can optionally specify a custom fade time to override the cue's fade time.</p>
<b>Get Active Cues</b>	<p>Passes the active cues on the selected Live page to the next action. If the current page is a cuelist then this will return no more than one cue.</p>
<b>Blind Mode</b>	<p>Enters or exits blind mode.</p>
<b>Find cues</b>	<p>Finds cues on the current Live page by their name.</p>
<b>Freeze Output</b>	<p>Freezes or unfreezes output.</p>
<b>Go to Cue in Cuelist</b>	<p>Activates the next or previous cue in the current cuelist.</p> <p>You can optionally specify a custom fade time to override the cue's fade time.</p>
<b>Pause/Resume Cuelist</b>	<p>Pauses or resumes playback of the current cuelist.</p>
<b>Select Live Page</b>	<p>Selects a page in the Live view.</p> <p>You can optionally specify a custom fade time to override the page's fade time.</p>
<b>Set Cue Intensity</b>	<p>Sets the intensity of one or more cues.</p> <p>You can choose one or more fixed cues, or use the output of a preceding action like Find Cues or Get Active Cues, or use a variable containing one or more cues.</p>
<b>Set Cue Modifier</b>	<p>Sets the value of a modifier of one or multiple cues.</p> <p>You can choose one or more fixed cues, or use the output of a preceding action like Find Cues or Get Active Cues, or use a variable containing one or more cues.</p>
<b>Set Frame Modifier</b>	<p>Sets the value of a modifier of one or multiple frames.</p>
<b>Activate Cue in Frame</b>	<p>Activates the next or previous cue in a frame.</p> <p>You can optionally specify a custom fade time to override the cue's fade time.</p>
<b>Set Master Dimmer</b>	<p>Sets the Master Dimmer level.</p>
<b>Set Tempo</b>	<p>Sets the beats per minute.</p>
<b>Start/Stop Cuelist</b>	<p>Starts or stops playback of the current cuelist.</p>

You can combine Lightkey's actions with other actions in the Shortcuts app to build your own workflows. For example, assume there's a cue named Panel Color which defines the color of some lights and has a Hue modifier. The following shortcut repeatedly sets the Hue modifier to a random value every 30 seconds, effectively applying a random color to the lights:

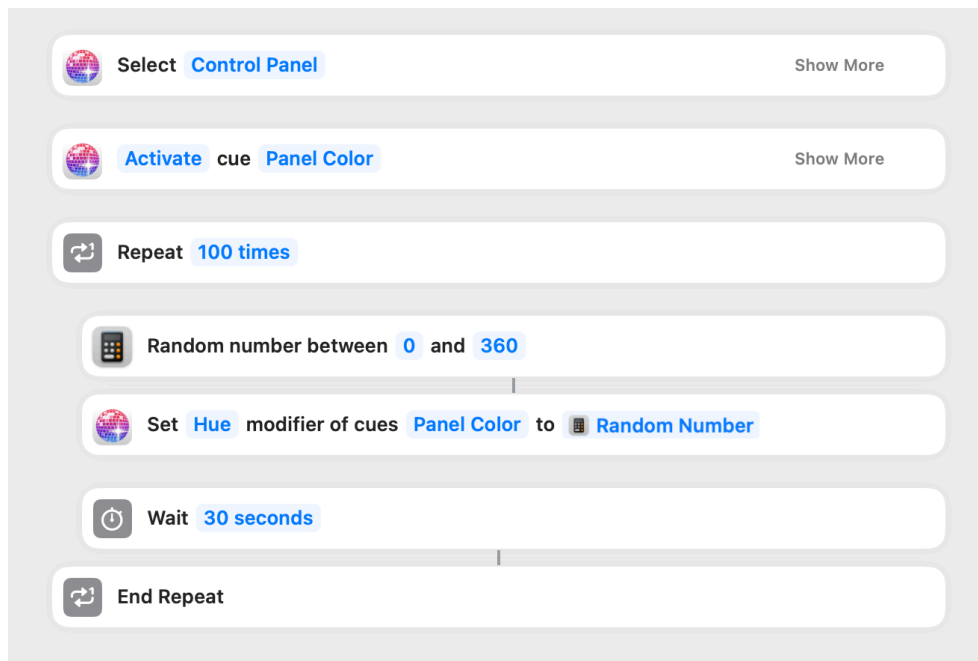

## Multi-Touch gestures

Lightkey supports configurable Multi-Touch gestures as an alternative way to quickly and conveniently change frequently-used fixture properties. You configure these gestures in Lightkey's Settings window.

### Configure Multi-Touch gestures

- ▶ Choose Lightkey → Settings... and click Gestures.

You can use gestures to control the following fixture properties:

- **Dimmer:** Change the selected fixture's Dimmer property.
- **Master dimmer:** Change the Master Dimmer.
- **Color hue:** Change the hue component of the selected fixture's color (if the fixture supports color mixing).
- **Color saturation:** Change the saturation component of the selected fixture's color (if the fixture supports color mixing).



You can control the fixture properties by scrolling or by swiping up or down with three or four fingers while the pointer is over the Preview area. These gestures can be combined with modifier keys. The swipe gestures require a Multi-Touch trackpad.

➤ **Important:** Three or four finger swipes can only be recognized when they are not assigned to another action in the Trackpad pane of System Settings (even when combined with modifier keys).

If you have a Multi-Touch trackpad, you can also pinch with two fingers while the pointer is over the Preview to open one of the HUDs for Position, Focus, Zoom, or Iris. This is especially useful for the Focus, Zoom, or Iris HUDs where pinching also changes the property value. You should assign this gesture to the fixture property which you most frequently use. If you choose Automatic, Lightkey will assign the gesture to the property supported by most of your fixtures.

If your trackpad supports Force Touch, you can force click a fixture icon to use one of the HUDs. This gesture is assigned to the Position HUD by default.

# Appendix 1

## Shortcuts and gestures

---

Lightkey's comprehensive system of keyboard shortcuts and gestures lets you control virtually every application feature.

### General

#### Application & windows

Action	Shortcut
Show Settings window	Command-Comma
Show Fixture Manager	Command-Shift-Down Arrow
Hide Fixture Manager	Command-Shift-Up Arrow or Command-Return
Open External Control window	Command-E
Hide Lightkey	Command-H
Hide other applications	Command-Option-H
Close window	Command-W
Minimize window	Command-M
Minimize all windows	Command-Option-M
Open DMX Monitor window	Command-Shift-Option-O

Action	Shortcut
Open User Guide	Command-?
Quit Lightkey	Command-Q

## Projects

Action	Shortcut
Open a project (when no project is open)	Command-O
Close the current project	Command-W
Save project	Command-S

## Editing

Action	Shortcut
Undo the last action	Command-Z
Redo the last action	Command-Shift-Z
Cut the selection	Command-X
Copy the selection	Command-C
Paste content of Clipboard	Command-V
Select all text or objects	Command-A
Show or hide the search field	Command-Option-F

## View

Action	Shortcut
Show Design view	Command-D
Show Live view	Command-L
Show/hide Preset Palette	Command-Shift-P
Show/hide shortcuts	Command-Shift-S
Enter/exit blind mode	Command-B

Action	Shortcut
Freeze/unfreeze output	Command-Period
Edit Preview	Command-J
Edit Live view	Command-Option-J
Set beats per minute	Shift-B or hold down B
Edit Design View	Command-Shift-Option-D
Enter/exit full screen	Command-F

## Project setup assistant

Action	Shortcut
Go to next step	Command-Right Arrow or Command-Return
Go to previous step	Command-Left Arrow

## Preview editing

### General

Action	Shortcut
Edit Preview or end editing	Command-J or Command-double-click Preview area
End editing Preview	Command-Return
Enable/disable highlight mode	Command-Shift-H
Scroll	Space-drag

### Selection

Action	Shortcut
Select all objects	Command-A
Deselect all objects	Command-Shift-A or Esc

Action	Shortcut
Select all fixtures of the same type as the selected fixture (e.g. all moving heads)	Command–Option–A
Select objects by dragging	Drag from a blank part of the Preview (Option–drag to select outward from starting point)
Add or remove an object from the selection	Shift–click or Command–click on object
Add or remove objects from the selection	Shift–drag or Command–drag from a blank part of the Preview
Select an individual fixture from a group	Double-click on fixture icon
Select fixtures by name	Type (lowercase) letters or numbers
Select next fixture, in alphabetical order	Control–Tab
Select previous fixture, in alphabetical order	Control–Shift–Tab

## Move

Action	Shortcut
Move selected objects by one unit	Arrow key
Move selected objects by ten units	Shift–arrow key

## Fixtures

Action	Shortcut
Create group from selected fixtures	Command–Option–G
Ungroup selected fixtures	Command–Option–G
Set beam direction of selected fixtures	Command–Shift–Option–P
Set beam color of selected fixtures (for fixtures with a fixed color)	Command–Shift–Option–C

## Shapes, text & images

Action	Shortcut
Duplicate selected objects	Command–Shift–D or Option–arrow key

Action	Shortcut
Duplicate selected objects by dragging	Option-drag
Constrain dragging to horizontal or vertical direction	Shift-drag
Disable alignment/spacing guides while dragging	Control-drag an object
Resize an object from the center	Option-drag a selection handle
Constrain a shape's aspect ratio while resizing	Shift-drag a selection handle
Do not constrain the aspect ratio of an image or round truss while resizing	Command-drag a selection handle
Rotate an object	Command-drag a selection handle
Rotate in 45° steps	Command-Shift-drag a selection handle
Rotate a line around its center	Option-drag a selection handle
Constrain a line's or arc's angle to 45°	Shift-drag a selection handle
Do not snap when changing a line or arc	Command-drag a selection handle
Disable alignment/spacing guides while resizing	Press Control while resizing
Begin or end editing a line's shape	Return
Move the selected handles while editing a line	Arrow keys
Delete the selected handles while editing a line	Delete
Begin or end text editing	Return
Show Font panel	Command-T
Show Color panel	Command-Shift-C

## Preview

### Selection

Action	Shortcut
Select all fixtures	Command-A
Deselect all fixtures	Command-Shift-A or Esc

Action	Shortcut
Select all fixtures of the same type as the selected fixture (e.g. all moving heads)	Command–Option–A
Select fixtures by dragging	Drag from a blank part of the Preview (Option–drag to select outward from starting point)
Add or remove a fixture from the selection	Shift–click or Command–click on fixture
Add or remove fixtures from the selection	Shift–drag or Command–drag from a blank part of the Preview
Select an individual fixture from a group	Double-click on fixture icon
Select fixtures by name	Type (lowercase) letters or numbers
Select next fixture, in alphabetical order	Control–Tab
Select previous fixture, in alphabetical order	Control–Shift–Tab
Select nearest fixture in arrow direction	Arrow keys
Extend fixture selection in arrow direction	Shift–arrow key

## Fixtures

Action	Shortcut
Show a fixture's shortcut menu	Click fixture name or right-click/Control–click fixture icon
Show overridden fixture properties	Command–P
Clear overridden properties for selected fixtures	Command–Delete
Clear overridden properties for all fixtures	Command–Shift–Delete
Show the selected fixture in Fixture Manager	Command–Shift–Down Arrow
Edit a fixture's profile	Command–Shift–Option–Down Arrow or Option–double-click fixture icon
Show DMX output for the selected fixture	Command–Shift–Option–O
Change dimmer of selected fixtures	Command–scroll up/down while mouse pointer is over Preview area <sup>2</sup>
Change hue of selected fixtures	Command–Option–scroll up/down while mouse pointer is over Preview area <sup>2</sup>
Change saturation of selected fixtures	Command–Option–scroll up/down while mouse pointer is over Preview area <sup>2</sup>

Action	Shortcut
Change master dimmer	Swipe up/down with four fingers while mouse pointer is over Preview area <sup>1, 2</sup>
Change focus, zoom, or iris for the selected fixtures (or the fixture under the mouse pointer if there is no selection)	Pinch gesture <sup>1, 2</sup>

<sup>1</sup> Requires multi-touch trackpad or Apple Magic Trackpad.

<sup>2</sup> This shortcut can be changed in the Settings window.

## Position

Action	Shortcut
Select Position property	Shift-P or hold down P or hold down mouse button over fixture icon or force click <sup>1</sup> fixture icon <sup>2</sup>
Clear (undefine) Position property	Space or Delete
Move beam to clicked location	Click in Position HUD
Lock pan	Command-drag
Lock tilt	Shift-drag
Don't snap	Control-drag
Set pan angle according to location of key	Numbers on numeric keypad
Change pan	Scroll up/down while mouse pointer is over Position HUD
Change tilt	Command-Scroll up/down while mouse pointer is over Position HUD
Increase/decrease pan angle by 1°	Right/Left Arrow
Increase/decrease pan angle by 10°	Shift-Right/Left Arrow
Increase/decrease pan angle by 0.1°	Option-Right/Left Arrow
Increase/decrease tilt angle by 1°	Up/Down Arrow or Plus/Minus
Increase/decrease tilt angle by 10°	Shift-Up/Down Arrow
Increase/decrease tilt angle by 0.1°	Option-Up/Down Arrow
Close Position HUD	Return, Enter or Esc



<sup>1</sup> Requires trackpad with Force Touch.

<sup>2</sup> This shortcut can be changed in the Settings window.

## Focus

Action	Shortcut
Select Focus property	Shift-F or hold down F
Clear (undefine) Focus property	Space or Delete
Set focus	Click in Focus HUD
Don't snap	Control-drag
Change focus	Pinch gesture <sup>1</sup> or scroll up/down while mouse pointer is over Focus HUD
Increase/decrease focus by 10%	Up/Down Arrow or Plus/Minus
Increase/decrease focus by 1%	Option-Up/Down Arrow
Set focus to an exact value	Type numbers
Close Focus HUD	Return, Enter or Esc

<sup>1</sup> Requires multi-touch trackpad or Apple Magic Trackpad.

## Zoom

Action	Shortcut
Select Zoom property	Shift-Z or hold down Z
Clear (undefine) Zoom property	Space or Delete
Set zoom angle	Click in Zoom HUD
Don't snap	Control-drag
Change zoom angle	Pinch gesture <sup>1</sup> or scroll up/down while mouse pointer is over Zoom HUD
Increase/decrease zoom angle by 1°	Up/Down Arrow or Plus/Minus
Set zoom to an exact angle	Type numbers
Close Zoom HUD	Return, Enter or Esc

<sup>1</sup> Requires multi-touch trackpad or Apple Magic Trackpad.

## Iris

Action	Shortcut
Select Iris property	Shift-I or hold down I
Clear (undefine) Iris property	Space or Delete
Set iris size	Click in Iris HUD
Don't snap	Control-drag
Change iris size	Pinch gesture <sup>1</sup> or scroll up/down while mouse pointer is over Iris HUD
Increase/decrease iris size by 10%	Up/Down Arrow or Plus/Minus
Increase/decrease iris size by 1%	Option-Up/Down Arrow
Set iris size to an exact value	Type numbers
Close Iris HUD	Return, Enter or Esc

<sup>1</sup> Requires multi-touch trackpad or Apple Magic Trackpad.

## Design view

### General

Action	Shortcut
Cycle through properties in Design view	Tab
Cycle backwards through properties in Design view	Shift-Tab
Clear (undefine) the selected property	Delete
Deselect current property	Return, Enter, or Esc
Don't snap sliders	Command-drag

### Dimmer

Action	Shortcut
Select Dimmer property	Shift-D or hold down D

Action	Shortcut
Increase/decrease intensity by 10%	Up/Down Arrow or Plus/Minus
Increase/decrease intensity by 1%	Option-Up/Down Arrow or Option-Plus/Minus
Set intensity to an exact value	Type numbers
Change Dimmer property of selected fixtures	Command-scroll up/down while mouse pointer is over Preview area <sup>1</sup>
Change Master Dimmer	Swipe up/down with four fingers while mouse pointer is over Preview area <sup>1</sup>

<sup>1</sup> This shortcut can be changed in the Settings window.

## Color

Action	Shortcut
Select Color property	Shift-C or hold down C

## Color Wheel

Action	Shortcut
Select a color	Arrow keys
Select color by index	Type numbers

## Color components

Action	Shortcut
Set hue to an exact value	Type numbers
Increase/decrease hue by 10°	Up/Down Arrow or Plus/Minus
Increase/decrease hue by 1°	Option-Up/Down Arrow or Option-Plus/Minus
Decrease/increase saturation by 10%	Left/Right Arrow
Decrease/increase saturation by 1%	Option-Left/Right Arrow

## Gobo

Action	Shortcut
Select Gobo property	Shift-G or hold down G
Select a gobo	Arrow keys
Select gobo by index	Type numbers
Toggle rotation or change rotation direction	R
Toggle bounce	B
Toggle indexing	I
Toggle shake	S
Decrease/increase speed or angle	Minus/Plus
Fine control of speed or angle	Option-Minus/Plus

## Shutter/Strobe

Action	Shortcut
Select Shutter/Strobe property	Shift-S or hold down S
Open shutter	O
Close shutter	C
Select strobe or change strobe mode	S
Select pulse or change pulse mode	P
Decrease/increase strobe/pulse speed	Up/Down Arrow or Minus/Plus
Fine control of strobe/pulse speed	Option-Up/Down Arrow or Option-Minus/Plus

Action	Shortcut
Toggle indexing	I
Decrease/increase speed or angle	Up/Down Arrow or Minus/Plus
Fine control of speed or angle	Option-Up/Down Arrow or Option-Minus/Plus

## Frost

Action	Shortcut
Select Frost property	Shift-R or hold down R
Frost on or off	O
Select linear	L
Select pulse	P
Decrease/increase frost amount	Left/Right Arrow or Minus/Plus
Fine control of frost amount	Option-Left/Right Arrow or Option-Minus/Plus
Set frost amount to an exact value	Type numbers

## Movement Speed

Action	Shortcut
Select tracking mode	T
Select vector mode	V
Select blackout mode	B
Set speed to an exact percent value	Type numbers
Increase/decrease speed by 10%	Left/Right Arrow or Plus/Minus
Increase/decrease speed by 1%	Option-Left/Right Arrow

## Fog

Action	Shortcut
Decrease/increase fog amount	Left/Right Arrow or Minus/Plus

Action	Shortcut
Fine control of fog amount	Option–Left/Right Arrow or Option–Minus/Plus
Set fog amount to an exact value	Type numbers

## Custom properties

Action	Shortcut
Show or hide options	Return or Enter
Select previous/next option	Up/Down Arrow
Decrease/increase percent or DMX value	Left/Right Arrow or Minus/Plus
Fine control of percent or DMX value	Option–Left/Right Arrow or Option–Minus/Plus
Set percent or DMX value	Type numbers
Select an option and hide the list of options	Double-click option

## Preset Palette

### Selection

Action	Shortcut
Extend the selection	Shift–click a row
Add or remove a row to/from the selection	Command–click a row
Clear the selection	Command–click the selected row

### Editing

Action	Shortcut
Create new preset	Command–N
Create new preset group	Command–Shift–N
Create new group from selected items	Command–Shift–Option–N
Create new sequence	Command–Ctrl–N

Action	Shortcut
Create new sequence from selected presets	Command–Ctrl–Option–N
Show info for sequence	Command–I or double-click a sequence
Edit the selected preset	Command–Shift–E or Double-click preset
End editing a preset	Command–Shift–E or Return or Enter
Cancel editing a preset	Esc
Edit hold or fade time	Click time
Increase/decrease hold or fade time by one second	Up/Down Arrow while editing time
Increase/decrease hold or fade time by 0.1 sec	Option–Up/Down Arrow while editing time
Increase/decrease hold or fade time by 10 sec	Shift–Up/Down Arrow while editing time
Jump to next field during editing	Tab
Jump to previous field during editing	Shift–Tab
Rename an item	Return or click the item’s name
Duplicate the selected items	Command–Shift–D
Duplicate one or more items	Option–drag
Delete the selected items	Delete
Delete an item	Swipe left over a row

## Live view

### General

Action	Shortcut
Show info for a button or frame	Command–click button or frame
Show info for a button	Force click on button <sup>1</sup>
Show properties defined in a cue	Command–Option–click button
Change a modifier in coarse steps	Hold down Shift while changing the modifier
Begin or end editing Live view	Command–Option–J or Command–double-click Live view

Action	Shortcut
End editing Live view	Command–Return

<sup>1</sup> Requires trackpad with Force Touch.

## Edit mode

Action	Shortcut
Scroll	Space–drag
Select all objects	Command–A
Deselect all objects	Command–Shift–A or Esc
Select objects by dragging	Drag from a blank part of the Live view (Option–drag to select outward from starting point)
Add or remove an object from the selection	Shift–click or Command–click an object
Add or remove objects from the selection	Shift–drag or Command–drag from a blank part of the Live view
Move selected objects by one unit	Arrow key
Move selected objects by five units	Shift–arrow key
Constrain dragging to horizontal or vertical direction	Shift–drag
Disable alignment guides and magnetic grid while dragging	Control–drag
Resize an object from the center	Option–drag a selection handle
Disable alignment guides and magnetic grid while resizing	Control–drag a selection handle
Show info for a button or frame	Command–I Double-click button or frame
Rename a button or frame	Return or click the button’s or frame’s name
Add a button to a frame	Drag button to frame
Cut the selected objects	Command–X
Copy the selected objects	Command–C
Paste objects (or cues) from Clipboard	Command–V
Duplicate selected objects	Command–Shift–D or Option–arrow key



Action	Shortcut
Duplicate selected objects by dragging	Option-drag
Delete selected objects	Delete
Begin or end text editing	Return
Show Font panel	Command-T
Show Color panel	Command-Shift-C

## Cuelists

Action	Shortcut
Extend the selection	Shift-click a row
Add or remove a row to/from the selection	Command-click a row
Show info for cue	Command-I or Command-click cue name or force click <sup>1</sup> cue
Show properties defined in a cue	Command-Option-click "Properties"
Activate cue	Double-click cue
Activate cue with fade	Option-double-click cue
Activate selected cue	Command-Return
Activate selected cue with fade	Command-Option-Return
Change a modifier in coarse steps	Hold down Shift while changing the modifier
Add new cue below the selected item	Command-Plus
Add new cue above the selected item	Shift-click the + icon
Add new group	Command-Shift-Plus
Add new group from selected items	Command-Shift-Option-Plus
Duplicate the selected items	Command-Option-D (or Option-click the + icon)
Duplicate one or more items by dragging	Option-drag
Rename an item	Return or click the item's name
Delete the selected items	Delete
Edit hold or fade time	Click time

Action	Shortcut
Increase/decrease hold or fade time by one second	Up/Down Arrow while editing time
Increase/decrease hold or fade time by 0.1 sec	Option-Up/Down Arrow while editing time
Increase/decrease hold or fade time by 10 sec	Shift-Up/Down Arrow while editing time
Jump to next field during editing	Tab
Jump to previous field during editing	Shift-Tab
Activate next cue	Space
Activate previous cue	Shift-Space
Activate cue by name (or number)	Command-G

<sup>1</sup> Requires trackpad with Force Touch.

## Effects

### General

Action	Shortcut
Add effect to selected fixtures	Command-Option-E
End effect editing	Return or Esc
Increment numeric value	Up Arrow or Plus
Decrement numeric value	Down Arrow or Minus
Numeric value fine control (not always available)	Option-Up Arrow or Option-Plus
Numeric value coarse control (not always available)	Shift-Up Arrow or Shift-Plus
Don't snap sliders	Command-drag

### Curve effects

Action	Shortcut
Select all control points	Command-A

Action	Shortcut
Deselect all control points	Command–Shift–A or Esc
Select the first or next control point	Control–Tab
Select the last or previous control point	Control–Shift–Tab
Move selected points	Arrow keys
Move in large steps	Shift–Arrow keys
Move in small steps	Option–Arrow keys
Constrain movement to horizontal or vertical direction	Shift–drag
Disable alignment guides and magnetic grid while moving	Control–drag
Add control point below pointer	Option-click on path
Delete selected control points	Delete
Transform points or curve	Return or Enter

## Movement paths

Action	Shortcut
Transform path	T
Exit transform mode	T or Esc
Close Position HUD	Return, Enter, or Esc
Add control point	Double-click on path
Delete selected control point	Delete
Lock pan while dragging control point	Command-drag
Lock tilt while dragging control point	Shift-drag
Don't snap while dragging control point	Control-drag
Set pan angle of selected control point according to location of key	Numbers on numeric keypad
Change pan of selected control point	Scroll up/down while mouse pointer is over Position HUD

Action	Shortcut
Change tilt of selected control point	Command–Scroll up/down while mouse pointer is over Position HUD
Increase/decrease pan angle of selected control point by 1°	Right/Left Arrow
Increase/decrease pan angle of selected control point by 10°	Shift–Right/Left Arrow
Increase/decrease tilt angle of selected control point by 1°	Up/Down Arrow or Plus/Minus
Increase/decrease tilt angle of selected control point by 10°	Shift–Up/Down Arrow

## Fixture Manager

### General

Action	Shortcut
Show Fixture Manager	Command–Shift–Down Arrow
Hide Fixture Manager	Command–Shift–Up Arrow or Command–Return

### Fixture library

Action	Shortcut
Move focus to search field	Command–Option–F
Get fixture profile info	Return or Double-click a fixture profile
Edit a fixture profile	Option–double-click a fixture profile

### Channel grid

Action	Shortcut
Select universe	Command–0 through Command–9
Select previous/next universe	Command–Shift–Left/Right Arrow
Select previous/next fixture	Left/Right Arrow

Action	Shortcut
Select first/last fixture	Command–Left/Right Arrow
Select fixtures by name	Type letters or numbers
Clear selection	Esc
Get fixture info	Return, double-click, or force click <sup>1</sup> a fixture
Edit a fixture's profile	Option–double click a fixture
Duplicate fixtures	Command–Option–D or Option–drag fixtures
Delete fixtures	Delete or drag fixtures out of grid

<sup>1</sup> Requires trackpad with Force Touch.

## Fixture info window

Action	Shortcut
Increase/decrease number of fixtures (when adding new fixtures)	Up/Down Arrow or Plus/Minus (while in fixture number field)
Increase/decrease fixture address	Up/Down Arrow or Plus/Minus (while in fixture address field)
Patch fixtures	Return or Enter
Don't patch fixtures	Esc

## Fixture editor

### Navigation

Action	Shortcut
Go to previous/next fixture profile (if multiple profiles are open)	Command–Shift–Left/Right Arrow
Select previous/next mode (for profiles with multiple modes)	Command–Up/Down Arrow
Manage modes	Command–Shift–Option–M
Scroll up	Page Up

Action	Shortcut
Scroll down	Page Down
Move focus to next field	Tab
Move focus to previous field	Shift-Tab
Close fixture profile	Command-W

## Numeric fields

Action	Shortcut
Increment value	Up Arrow or Plus
Decrement value	Down Arrow or Minus

## Multiple settings

Action	Shortcut
Add setting below the current one (for properties with multiple settings, e.g. Gobo)	Command-Plus
Add setting above the current one	Command-Shift-Plus (or Shift-click the + icon)
Duplicate the current setting (for properties with multiple settings)	Command-Option-Plus (or Option-click the + icon)
Remove the current setting (for properties with multiple settings)	Command-Minus

## Custom capabilities

Action	Shortcut
Toggle default setting	Command-Option-X
Toggle slider	Command-Option-S

## Beams

Action	Shortcut
Assign a property to a particular beam (when the property's beam settings are visible)	Click a beam
Select beams by index (when the property's beam settings are visible)	Type numbers or a range (e.g. "1-4")
Add or remove beam from selection (when the property's beam settings are visible)	Command-click a beam
Select a range of beams (when the property's beam settings are visible)	Shift-click a beam

## External Control window

Action	Shortcut
Open External Control window	Command-E
Switch between categories	Command-1, 2, 3
Move focus to search field	Command-Option-F
Cancel search (while focus is in search field)	Esc
Cut the selected bindings	Command-X
Copy the selected bindings	Command-C
Paste bindings from Clipboard	Command-V
Duplicate the selected bindings	Command-Shift-D
Delete the selected bindings	Delete
Capture trigger for selected binding	Return or Enter
Cancel capturing trigger	Esc, Return, or Enter

## External Control Log window

Action	Shortcut
Open External Control Log	Command-Option-Shift-E
Switch between categories	Command-1, 2, 3

Action	Shortcut
Move focus to search field	Command–Option–F
Cancel search (while focus is in search field)	Esc
Copy the selected log entries	Command–C

## User Guide viewer

Action	Shortcut
Open User Guide	Command–?
Scroll up	Page Up or Shift–Space
Scroll down	Page Down or Space
Go to previous search result (while focus is in search field)	Shift–Return
Go to next search result (while focus is in search field)	Return
Cancel search (while focus is in search field)	Esc
Zoom In	Command–Plus
Zoom Out	Command–Minus



# Appendix 2

## Generic fixture profiles

---

The following table provides an overview of the generic fixture profiles in the built-in library.

Profile name	Use for
Bulb	Monochrome light bulb, one channel (Dimmer)
Fog Machine	Fog machine or hazer, one channel (fog amount)
LED Matrix (DRGB)	Flexible matrix, four channels per pixel (Dimmer, Red, Green, Blue)
LED Matrix (Mono)	Flexible monochrome matrix, one channel per pixel (Dimmer)
LED Matrix (RGB)	Flexible matrix, three channels per pixel (Red, Green, Blue)
LED Matrix (RGBA)	Flexible matrix, four channels per pixel (Red, Green, Blue, Amber)
LED Matrix (RGBAW)	Flexible matrix, five channels per pixel (Red, Green, Blue, Amber, White)
LED Matrix (RGBD)	Flexible matrix, four channels per pixel (Red, Green, Blue, Dimmer)
LED Matrix (RGBW)	Flexible matrix, four channels per pixel (Red, Green, Blue, White)
LED Strip (DRGB)	Flexible LED strip, four channels per pixel (Dimmer, Red, Green, Blue)
LED Strip (Mono)	Flexible Monochrome LED strip, one channel per pixel (Dimmer)
LED Strip (RGB)	Flexible LED strip, three channels per pixel (Red, Green, Blue)

Profile name	Use for
LED Strip (RGBA)	Flexible LED strip, four channels per pixel (Red, Green, Blue, Amber)
LED Strip (RGBAW)	Flexible LED strip, five channels per pixel (Red, Green, Blue, Amber, White)
LED Strip (RGBD)	Flexible LED strip, four channels per pixel (Red, Green, Blue, Dimmer)
LED Strip (RGBW)	Flexible LED strip, four channels per pixel (Red, Green, Blue, White)
PAR Beam	Conventional beam light, one channel (monochrome)
PAR Spot	Conventional spot, one channel (monochrome)
PAR Spot (DRGB)	Spot light, four channels (Dimmer, Red, Green, Blue)
PAR Spot (RGB)	Spot light, three channels (Red, Green, Blue)
PAR Spot (RGBAW)	Spot light, five channels (Red, Green, Blue, Amber, White)
PAR Spot (RGBW)	Spot light, four channels (Red, Green, Blue, White)
PAR Wash	Conventional wash light, one channel (monochrome)
PAR Wash (DRGB)	Wash light, four channels (Dimmer, Red, Green, Blue)
PAR Wash (RGB)	Wash light, three channels (Red, Green, Blue)
PAR Wash (RGBAW)	Wash light, five channels (Red, Green, Blue, Amber, White)
PAR Wash (RGBW)	Wash light, four channels (Red, Green, Blue, White)
Switch	DMX switch, one channel: Off (0) or On (255)

The remaining profiles in the Generic category are for demo purposes and shouldn't be used to control real fixtures.



# Enjoy Lightkey!

---

Thank you for choosing Lightkey: We hope that it enhances your creative process and wish you lots of fun creating exciting and impressive light shows.

If you have any questions that weren't answered in this User Guide, need technical support, or want to share your feedback, get in touch with our [support team](#).

We're happy to help!

© 2025 Monospace GmbH. All rights reserved.

Every effort has been made to ensure that the information in this manual is accurate. Monospace assumes no responsibility or liability for any errors or inaccuracies that may appear in this manual.

Any company and product names mentioned herein may be trademarks of their respective companies. Mention of third-party products is for informational purposes only and constitutes neither an endorsement nor a recommendation. Monospace assumes no responsibility with regard to the performance or use of these products.

This manual describes the features of the software version it was distributed with. If you are using a newer or older Lightkey version please refer to the User Guide that comes with your version.

Rev. 5.2.